



# THE ANSWER BOOK

## Higher Worksheets

### Grades 1 to 9

Grade 1

Grade 6

Grade 2

Grade 7

Grade 3

Grade 8

Grade 4

Grade 9

Grade 5

#### Instructions for use

Clicking on something like this **Grade 4** will take you to the Grade 4 clip numbers and titles.



Clicking on something like this **Compound Units. . . . . 142** will take you to Worksheet 142.



Clicking on something like this **©MathsWatch | Clip 142** will take you back to the contents page.

*Grade 4 questions*





Take me to . . .

Grade 1

Grade 2

Grade 3

Grade 4

Grade 5

Grade 6

Grade 7

Grade 8

Grade 9

## Grade 1 Foundation and Higher

Place Value . . . . .	1
Ordering Integers . . . . .	2
Ordering Decimals . . . . .	3
Reading Scales . . . . .	4
Simple Mathematical Notation . . . . .	5
Interpreting Real-Life Tables . . . . .	6
Introduction to Algebraic Conventions . . . . .	7
Coordinates . . . . .	8
Simple Geometric Definitions . . . . .	9
Polygons . . . . .	10
Symmetries . . . . .	11
Tessellations and Congruent Shapes . . . . .	12
Names of Angles . . . . .	13
The Probability Scale . . . . .	14
Tally Charts and Bar Charts . . . . .	15
Pictograms . . . . .	16



Take me to . . .

Grade 1

Grade 2

Grade 3

Grade 4

Grade 5

Grade 6

Grade 7

Grade 8

Grade 9

## Grade 2 Foundation and Higher

Adding Integers and Decimals . . . . .	17
Subtracting Integers and Decimals . . . . .	18
Multiplying Integers . . . . .	19
Dividing Integers . . . . .	20
Inverse Operations . . . . .	21
Money Questions . . . . .	22
Negatives in Real Life . . . . .	23
Introduction to Fractions . . . . .	24
Equivalent Fractions . . . . .	25
Simplifying Fractions . . . . .	26
Half-Way Values . . . . .	27
Factors, Multiples and Primes . . . . .	28
Introduction to Powers/Indices . . . . .	29
Multiply and Divide by Powers of 10 . . . . .	30
Rounding to the Nearest 10, 100 etc . . . . .	31
Rounding to Decimal Places . . . . .	32
<b>Simplifying - Addition and Subtraction . . . . .</b>	<b>33</b>
<b>Simplifying - Multiplication . . . . .</b>	<b>34</b>
<b>Simplifying - Division . . . . .</b>	<b>35 A/B</b>
<b>Function Machines . . . . .</b>	<b>36</b>
<b>Generating a Sequence - Term to Term . . . . .</b>	<b>37</b>
Introduction to Ratio . . . . .	38
Using Ratio for Recipe Questions . . . . .	39
Introduction to Percentages . . . . .	40
Value for Money . . . . .	41
Introduction to Proportion . . . . .	42



Take me to . . .

Grade 1

Grade 2

Grade 3

Grade 4

Grade 5

Grade 6

Grade 7

Grade 8

Grade 9

**Grade 2** Foundation and Higher

Properties of Solids . . . . .	43
Nets . . . . .	44
Angles on a Line and at a Point . . . . .	45
Measuring and Drawing Angles . . . . .	46
Drawing a Triangle Using a Protractor . . . . .	47
Reflections . . . . .	48
Rotations . . . . .	49
Translations . . . . .	50
Plans and Elevations . . . . .	51A/B/C/D
Perimeters . . . . .	52
Area of a Rectangle . . . . .	53
Area of a Triangle . . . . .	54
Area of a Parallelogram . . . . .	55
Area of a Trapezium . . . . .	56
Frequency Trees . . . . .	57
Listing Outcomes . . . . .	58
Calculating Probabilities . . . . .	59
Mutually Exclusive Events . . . . .	60
Two-Way Tables . . . . .	61
Averages and the Range . . . . .	62
Data - Discrete and Continuous . . . . .	63
Vertical Line Charts . . . . .	64
Frequency Tables and Diagrams . . . . .	65



Take me to . . .

Grade 1

Grade 2

Grade 3

Grade 4

Grade 5

Grade 6

Grade 7

Grade 8

Grade 9

## Grade 3 Foundation and Higher

Multiplying Decimals . . . . .	66
Dividing Decimals. . . . .	67
Four Rules of Negatives. . . . .	68
Listing Strategies . . . . .	69
Comparing Fractions . . . . .	70
Adding and Subtracting Fractions . . . . .	71
Finding a Fraction of an Amount . . . . .	72
Multiplying Fractions . . . . .	73
Dividing Fractions. . . . .	74
BODMAS/BIDMAS. . . . .	75
Reciprocals . . . . .	76
Calculator Questions . . . . .	77
Product of Primes. . . . .	78
Highest Common Factor (HCF) . . . . .	79
Lowest Common Multiple (LCM) . . . . .	80 A/B
Squares, Cubes and Roots . . . . .	81
Working with Indices . . . . .	82
Standard Form . . . . .	83
Decimals and Fractions . . . . .	84
Fractions, Percentages, Decimals . . . . .	85
Percentage of an Amount (Calc.) . . . . .	86
Percentage of an Amount (Non-Calc.) . . . . .	87
Change to a Percentage (Calc.) . . . . .	88
Change to a Percentage (Non-Calc.) . . . . .	89 A/B
Rounding to Significant Figures . . . . .	90
Estimating Answers . . . . .	91
Using Place Value . . . . .	92



Take me to . . .

Grade 1

Grade 2

Grade 3

Grade 4

Grade 5

Grade 6

Grade 7

Grade 8

Grade 9

Grade 3 Foundation and Higher

Expanding Brackets . . . . . 93

Simple Factorisation . . . . . 94

Substitution . . . . . 95

Straight Line Graphs . . . . . 96 A/B/C

The Gradient of a Line . . . . . 97

Drawing Quadratic Graphs . . . . . 98 A/B/C/D/E

Sketching Functions . . . . . 99

Solving Equations Using Flowcharts . . . . . 100

Subject of a Formula Using Flowcharts . . . . . 101

Generate a Sequence from the *n*th Term . . . . . 102

Finding the *n*th Term . . . . . 103 A/B/C

Special Sequences . . . . . 104

Exchanging Money . . . . . 105

Sharing Using Ratio . . . . . 106

Ratios, Fractions and Graphs . . . . . 107

Increase/Decrease by a Percentage . . . . . 108

Percentage Change . . . . . 109

Reverse Percentage Problems . . . . . 110

Simple Interest . . . . . 111

Grade 3 continued



Take me to . . .

Grade 1

Grade 2

Grade 3

Grade 4

Grade 5

Grade 6

Grade 7

Grade 8

Grade 9

**Grade 3** Foundation and Higher

Metric Conversions . . . . .	112
Problems on Coordinate Axes . . . . .	113
Surface Area of a Prism . . . . .	114 A/B
Volume of a Cuboid . . . . .	115
Circle Definitions . . . . .	116
Area of a Circle . . . . .	117
Circumference of a Circle . . . . .	118 A/B/C
Volume of a Prism . . . . .	119 A/B
Angles and Parallel Lines . . . . .	120 A/B/C
Angles in a Triangle . . . . .	121
Properties of Special Triangles . . . . .	122
Angle Sum of Polygons . . . . .	123 A/B
Bearings . . . . .	124 A/B
Experimental Probabilities . . . . .	125
Possibility Spaces . . . . .	126
Venn Diagrams . . . . .	127
Representing Data . . . . .	128
Scatter Diagrams . . . . .	129 A/B/C/D
Averages From a Table . . . . .	130



Take me to . . .

Grade 1

Grade 2

Grade 3

Grade 4

Grade 5

Grade 6

Grade 7

Grade 8

Grade 9

Grade 4 Foundation and Higher

Index Notation . . . . . 131 A/B

Introduction to Bounds . . . . . 132

Midpoint of a Line on a Graph . . . . . 133

Expanding and Simplifying Brackets . . . . . 134 A/B

Solving Equations . . . . . 135

Rearranging Simple Formulae . . . . . 136

Forming Formulae and Equations . . . . . 137 A/B/C

Inequalities on a Number Line . . . . . 138

Solving Linear Inequalities . . . . . 139 A/B

Simultaneous Equations Graphically . . . . . 140

Fibonacci Sequences . . . . . 141

Compound Units . . . . . 142 A/B

Distance-Time Graphs . . . . . 143

Similar Shapes . . . . . 144 A/B/C

Bisecting an Angle . . . . . 145

Constructing Perpendiculars . . . . . 146

Drawing a Triangle Using Compasses . . . . . 147

Enlargements . . . . . 148

Tangents, Arcs, Sectors and Segments . . . . . 149

Pythagoras' Theorem . . . . . 150 A/B/C

Simple Tree Diagrams . . . . . 151 A/B/C

Sampling Populations . . . . . 152

Time Series . . . . . 153





Take me to . . .

Grade 1

Grade 2

Grade 3

Grade 4

Grade 5

Grade 6

Grade 7

Grade 8

Grade 9

Grade 5 Foundation and Higher

Negative Indices. . . . . 154

Error Intervals. . . . . 155

Mathematical Reasoning . . . . . 156

Factorising and Solving Quadratics . . . . . 157

The Difference of Two Squares . . . . . 158

Finding the Equation of a Straight Line . . . . . 159 A/B

Roots and Turning Points of Quadratics . . . . . 160

Cubic and Reciprocal Graphs . . . . . 161

Simultaneous Equations Algebraically . . . . . 162

Geometric Progressions. . . . . 163

Compound Interest and Depreciation . . . . . 164

Loci. . . . . 165 A/B/C

Congruent Triangles. . . . . 166 A/B

Sectors of a Circle . . . . . 167

Trigonometry . . . . . 168 A/B/C/D/E

Spheres . . . . . 169

Pyramids . . . . . 170

Cones. . . . . 171 A/B/C

Frustums . . . . . 172

Exact Trigonometric Values . . . . . 173

Introduction to Vectors . . . . . 174

Harder Tree Diagrams . . . . . 175 A/B/C

Stratified Sampling . . . . . 176 A/B



Take me to . . .

Grade 1

Grade 2

Grade 3

Grade 4

Grade 5

Grade 6

Grade 7

Grade 8

Grade 9

Grade 6 Higher

Recurring Decimals to Fractions . . . . .	177
Product of Three Binomials . . . . .	178
Iteration - Trial and Improvement . . . . .	179
Iterative Processes . . . . .	180
Enlargement - Negative Scale Factor . . . . .	181
Combinations of Transformations . . . . .	182 <sup>A/B/C/D/E</sup> <sub>F/G/H/I/J</sub>
Circle Theorems . . . . .	183 <sup>A/B/C/D/E/F</sup>
Proof of Circle Theorems . . . . .	184
Probability Using Venn Diagrams . . . . .	185
Cumulative Frequency . . . . .	186 <sup>A/B/C/D/E/F</sup>
Boxplots . . . . .	187 <sup>A/B/C/D</sup>



Take me to . . .

Grade 1

Grade 2

Grade 3

Grade 4

Grade 5

Grade 6

Grade 7

Grade 8

Grade 9

Grade 7 Higher

Fractional Indices . . . . .	188
Recurring Decimals - Proof . . . . .	189
Rearranging Difficult Formulae . . . . .	190
Solving Quadratics with the Formula . . . . .	191
Factorising Hard Quadratics . . . . .	192
Algebraic Proof. . . . .	193
Exponential Functions . . . . .	194
Trigonometric Graphs. . . . .	195 A/B
Transformation of Functions. . . . .	196 A/B/C/D/E
Equation of a Circle . . . . .	197
Regions . . . . .	198
Direct and Inverse Proportion. . . . .	199 A/B
Similarity - Area and Volume . . . . .	200
The Sine Rule . . . . .	201
The Cosine Rule . . . . .	202
Area of a Triangle Using Sine . . . . .	203
And and Or Probability Questions . . . . .	204
Histograms . . . . .	205 A/B/C/D E/F/G/H



Take me to . . .

Grade 1

Grade 2

Grade 3

Grade 4

Grade 5

Grade 6

Grade 7

Grade 8

Grade 9

Grade 8

Grade 9

Higher

Upper and Lower Bounds . . . . .	206 A/B/C
Surds . . . . .	207 A/B/C
Perpendicular Lines . . . . .	208
Completing the Square . . . . .	209
Algebraic Fractions . . . . .	210 A/B
Simultaneous Equations with a Quadratic . . . . .	211
Solving Quadratic Inequalities . . . . .	212
Finding the <i>n</i> th Term of a Quadratic . . . . .	213
Inverse Functions . . . . .	214
Composite Functions . . . . .	215
Velocity-Time Graphs . . . . .	216
Pythagoras in 3D . . . . .	217
Trigonometry in 3D . . . . .	218
Vectors . . . . .	219 A/B/C/D/E

- 1) a) Write the number forty five thousand, two hundred and seventy three in figures. **45 273**  
b) Write the number five thousand, one hundred and three in figures. **5 103**  
c) Write the number three hundred thousand, seven hundred and ninety one in figures. **300 791**  
d) Write the number two and a half million in figures. **2 500 000**  
e) Write the number one and three quarter million in figures. **1 750 000**
- 2) Write the following numbers in words  
a) 1 250 **One thousand, two hundred and fifty**  
b) 3 502 **Three thousand, five hundred and two**  
c) 72 067 **Seventy two thousand and sixty seven**  
d) 192 040 **One hundred and ninety two thousand and forty**  
e) 30 000 000 **Thirty million**
- 3) a) Write down the value of the 7 in the number 3 752. **700 or seven hundred**  
b) Write down the value of the 6 in the number 56 025. **6 000 or six thousand**  
c) Write down the value of the 2 in the number 99 723. **20 or twenty**  
d) Write down the value of the 5 in the number 258 610. **50 000 or fifty thousand**  
e) Write down the value of the 2 in the number 1 253 549. **200 000 or two hundred thousand**
- 4) What is the value of the digit 7 in 38.1472?

Choose, and circle, the correct answer from the following:

$\frac{7}{10}$      $\frac{7}{100}$      $\frac{7}{1000}$      $\frac{7}{10000}$

Put these numbers in order, starting with the smallest:

- 1) 74, 57, 38, 8, 61    **8, 38, 57, 61, 74**
  
- 2) 39, 84, 11, 128, 24    **11, 24, 39, 84, 128**
  
- 3) 76, 102, 12, 140, 73    **12, 73, 76, 102, 140**
  
- 4) 3, -2, -7, 10, -1    **-7, -2, -1, 3, 10**
  
- 5) -3, -11, 1, -5, 7    **-11, -5, -3, 1, 7**
  
- 6) -4, 6, 0, -6, -1    **-6, -4, -1, 0, 6**
  
- 7) 205, 2005, 105, 55, 5005    **55, 105, 205, 2005, 5005**
  
- 8) 83, -61, -42, 65, -14    **-61, -42, -14, 65, 83**

1) Put these amounts of money in order, starting with the smallest:

a) £4.50, £3.82, £4.05, £3.99, £3.54    **£3.54, £3.82, £3.99, £4.05, £4.50**

b) £1.25, £2.41, £1.24, £2.04, £1.99    **£1.24, £1.25, £1.99, £2.04, £2.41**

c) £15.83, £24.18, £13.99, £46.01, £46.10    **£13.99, £15.83, £24.18, £46.01, £46.10**

2) Circle the smallest number: 0.1, **0.09**, 0.99, 0.15, 0.11

3) Put these numbers in order, starting with the smallest:

2.01, 2.45, 2.14, 2.006, 2.405    **2.006, 2.01, 2.14, 2.405, 2.45**

4) Put these numbers in order, starting with the smallest:

0.76, 0.668, 0.608, 0.099, 0.909    **0.099, 0.608, 0.668, 0.76, 0.909**

5) Put these numbers in order, starting with the smallest:

5.004, 4.889, 4.099, 5.002, 4.095    **4.095, 4.099, 4.889, 5.002, 5.004**

## Reading Scales

1) Estimate the reading on each of these scales:

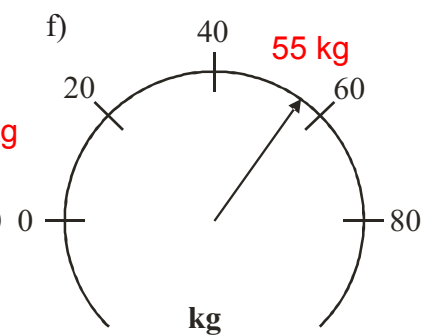
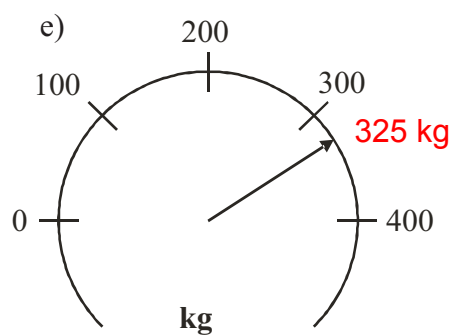
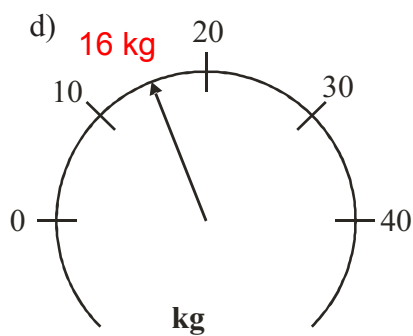
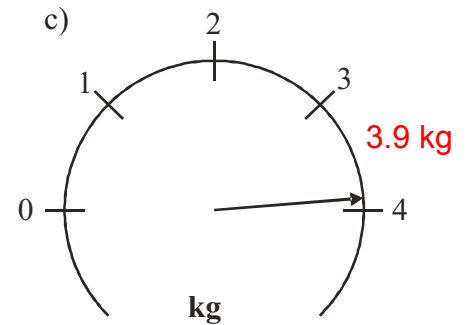
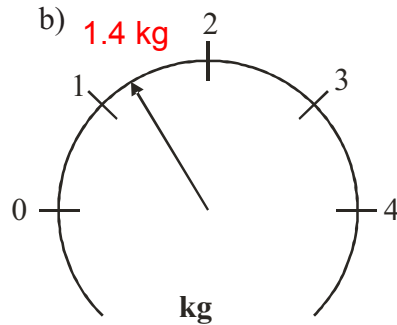
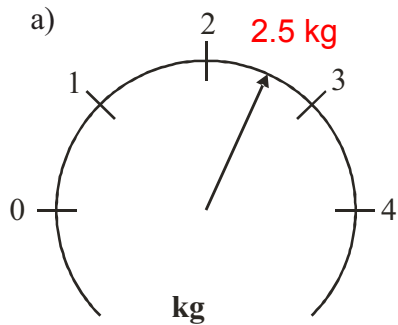

2) This scale shows degrees Centigrade.

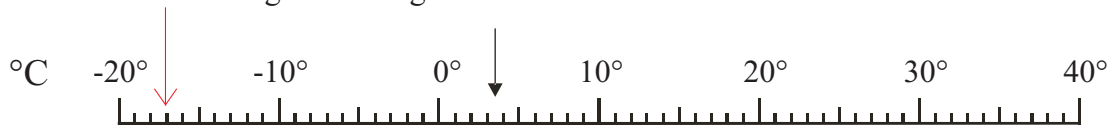

a) What temperature is the arrow pointing to? **3.5°C**

b) Draw an arrow which points to -17°C.

3) This is a diagram for converting between gallons and litres.

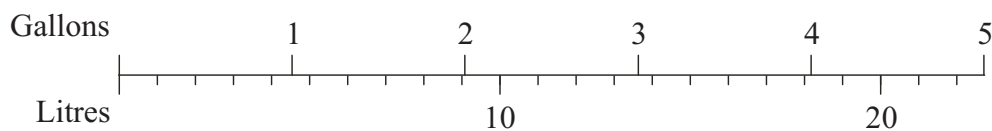

Use the diagram to convert

a) 3 gallons to litres. **13.7 litres**

b) 4.5 gallons to litres. **20.5 litres**

c) 6 litres to gallons. **1.3 gallons**



- 1) For each mathematical sign, below, write a brief description of the sign.  
The first one has already been done.

a)  $<$  less than

b) more than or equal to

c)  $>$  more than

d) less than or equal to

e)  $\neq$  not equal to

- 2) Insert one of the two symbols  $<$  or  $>$  to make the following statements true:

a)  $8 \dots 5$

b)  $-4 \dots -6$

c)  $2.08 \dots 2.8$

d)  $8 + 3 \dots 2 + 7$

e)  $2 - 7 \dots 5 - 8$

- 3) You must be at least 1.6 m tall to ride on a rollercoaster at Romy Park.  
Circle the correct description of this out of the following:

Height  $<$  1.6 m

Height  $\leq$  1.6 m

Height = 1.6 m

Height  $\geq$  1.6 m

Height  $>$  1.6 m

## Interpreting Real-Life Tables

- 1) Calculate the difference in hours and minutes between 9.30 am and 2.45 pm. **5 hours 15 minutes**
- 2) Calculate the difference in hours and minutes between 11 35 and 13 25. **1 hour 50 minutes**
- 3) The table shows the distances in kilometres between some cities in the USA.

San Francisco			
4827	New York		
4990	2132	Miami	
668	4541	4375	Los Angeles
3493	1352	2183	3366

Chicago

- a) Write down the distance between San Francisco and Miami. **4990 km**
- One of the cities in the table is 4541 km from Los Angeles.
- b) Write down the name of this city. **New York**
  - c) Write down the name of the city which is furthest from Chicago. **San Francisco**
- 4) Here is part of a train timetable

Manchester	05 15	06 06	06 45	07 05	07 15	07 46
Stockport	05 26	06 16	06 55	07 15	07 25	07 55
Macclesfield	05 39	06 29	07 08		07 38	08 08
Stoke	05 54	06 45	07 24		07 54	08 24
Stafford	06 12		07 41		08 11	
Euston	08 09	08 26	09 06	09 11	09 50	10 08

- a) Tim catches the 06 06 train from Manchester.  
At what time should he expect to arrive at Euston? **08 26**
- b) Jenny arrives at the Stockport train station at 07 00
  - (i) How long should she expect to wait for a train to Stoke? **25 minutes**
  - (ii) How long should her train journey take? **29 minutes**
- c) Sarah needs to travel to Euston from Macclesfield.  
She has to arrive at Euston before 09 30.  
What is the departure time of the latest train she can catch to get there on time? **07 08**

1) Write the following in their simplest forms using algebraic notation:

a)  $r \times 5$      $5r$

b)  $c \div 4$      $\frac{c}{4}$

c)  $x + x + x + x$      $4x$

d)  $e \times 1$      $e$

2) Write the following using algebraic notation:

a) I think of a number and multiply it by 4.     $4x$

b) I think of a number, multiply it by 6 and then add 5.     $6x + 5$

c) I think of a number, triple it and then subtract 7.     $3x - 7$

3) Write the following using algebraic notation:

a) I think of a number, add 2 and then multiply the result by 3.     $3(x + 2)$  or  $3x + 6$

b) I think of a number, subtract 6 and then divide the result by 2.     $\frac{x - 6}{2}$

4) Write the following using algebraic notation:

a) I think of a number, add 9, multiply the result by 4 and then divide everything by 2.     $\frac{4(x + 9)}{2}$     or     $\frac{4x + 36}{2}$

b) I think of a number, take away 5, divide the result by 3 and then multiply the result by 2.     $2\left(\frac{x - 5}{3}\right)$

## Coordinates

1) Write down the coordinates of the points A to H.

- A (8, 8)
- B (3, 9)
- C (1, 6)
- D (0, 2)
- E (6, 5)
- F (4, 3)
- G (5, 0)
- H (10, 2)

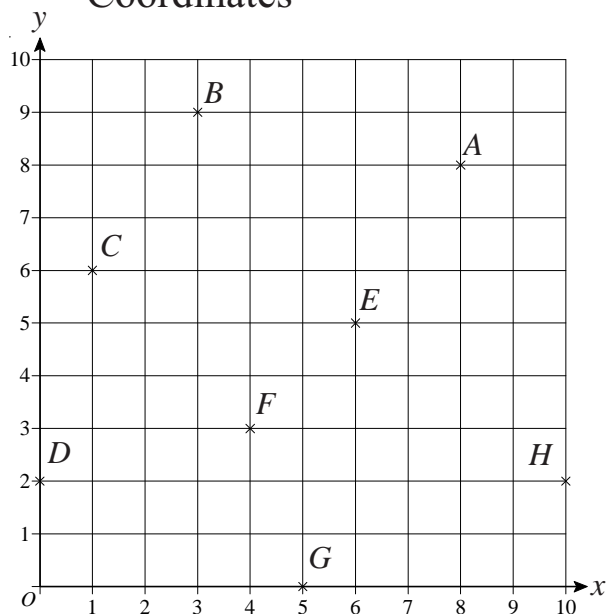

2) a) Write down the coordinates of: (i) A (1, 3) (ii) B (5, 5)  
b) Write down the coordinates of the midpoint of the line AB. (3, 4)

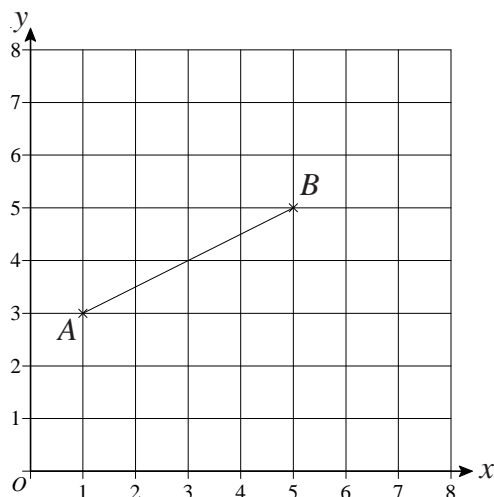

3) Using the pair of axes,  
a) Plot the points A(2, 0), B(4, 0), C(5, 2) and D(3, 2).

- b) Join the points in order, to form a shape and name the shape.  
**Parallelogram**  
M is the midpoint of the line segment AC.  
c) Find the coordinates of M. (3.5, 1)

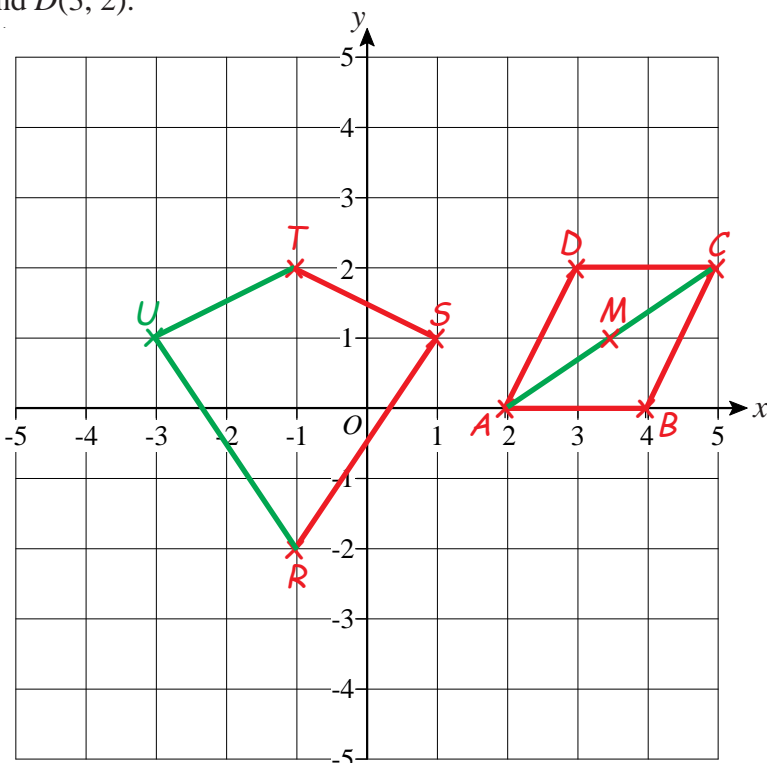

4) Using the same pair of axes,  
a) Plot the points R(-1, -2), S(1, 1) and T(-1, 2).  
b) Join R to S and S to T.  
RSTU is a kite.  
c) Write the coordinates of point U.  
(-3, 1)

1) Write one or two short sentences which say what the special features are of the triangles listed, below.  
The first one has been done for you.

- a) An equilateral triangle **All the sides are the same length.**  
**All three angles are  $60^\circ$**
- b) A right-angled triangle **Has one angle of  $90^\circ$**
- c) A scalene triangle **All the sides are different lengths.**  
**All the angles are different sizes.**
- d) An isosceles triangle **Two sides are the same length.**  
**Two angles are the same size.**

2) Next to each of the quadrilaterals, write down its special name.

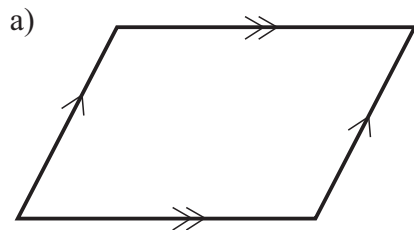

**Parallelogram**

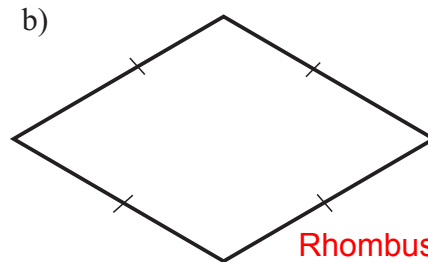

**Rhombus**

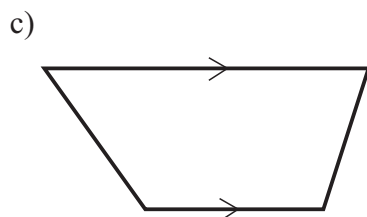

**Trapezium**

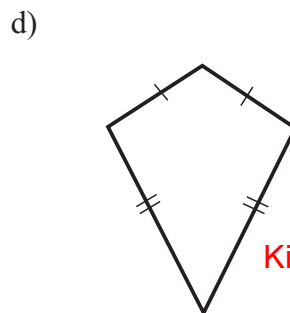

**Kite**

# Polygons

1) Next to each of the shapes, write down its name.

a)

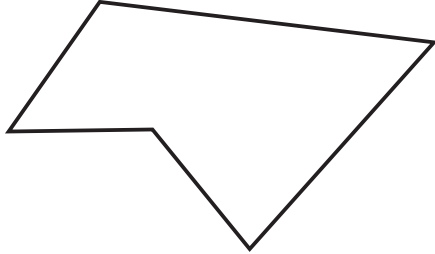

(Irregular) pentagon

b)

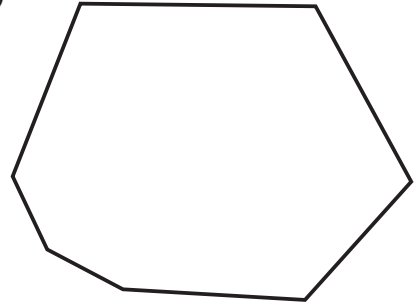

(Irregular) heptagon or septagon

2) a) What is the name given to a 10-sided shape? **Decagon**

b) What is the name given to an 8-sided shape? **Octagon**

3) To be a regular polygon the shape must have equal sides and equal angles.

Fill in the blanks.

4) What are the names of these regular polygons?

a)

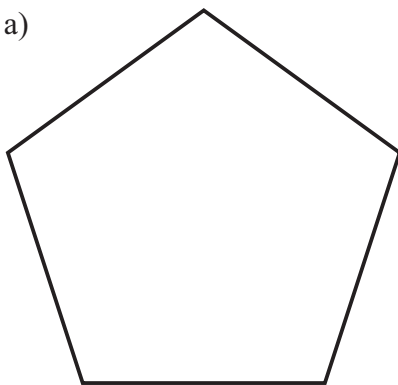

**Pentagon**

b)

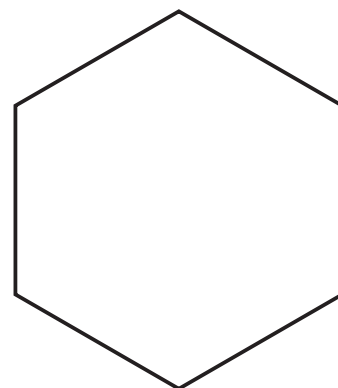

**Hexagon**

- 1) Draw all the lines of symmetry on the triangle and the rectangle.

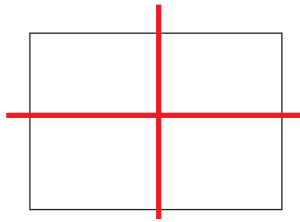
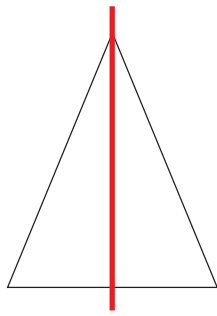

- 2) What is the order of rotational symmetry of the two shapes below?

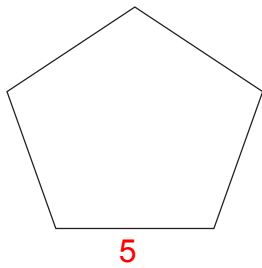

- 3) The diagram below, shows part of a shape.

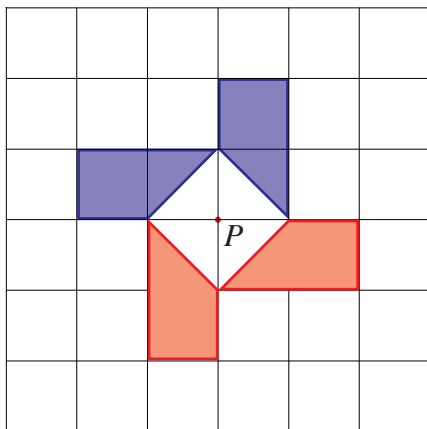

The shape has rotational symmetry of order 4 about point  $P$ .

Complete the shape.

- 4) On each of the shapes below, draw one plane of symmetry.

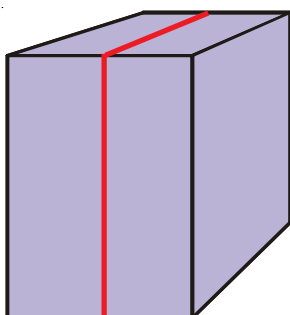

Other answers are possible

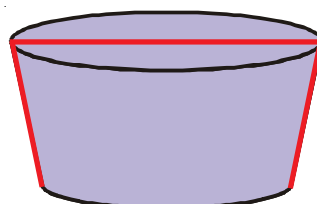

Other answers are possible

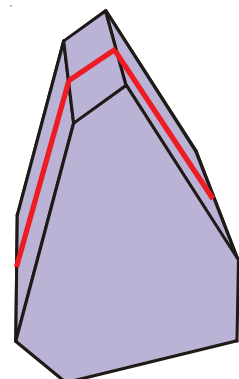

- 1) Show how this shape will tessellate.  
You must draw six more shapes.

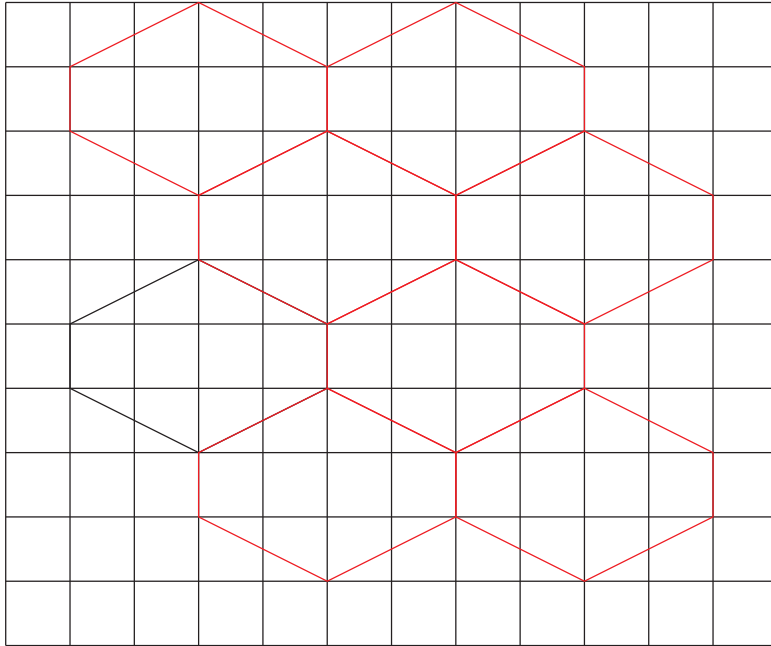

- 2) Two of these shapes are congruent.  
Which are they? **b and d**

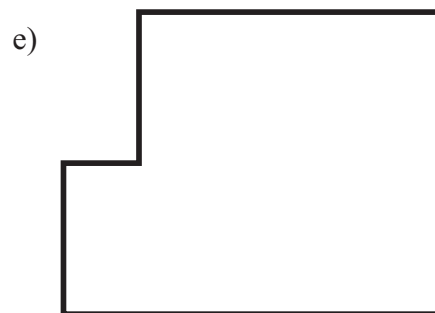
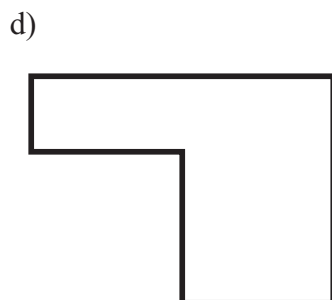
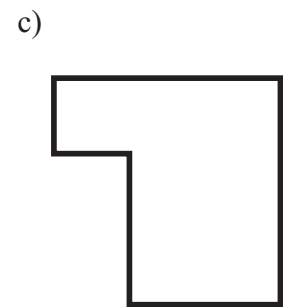
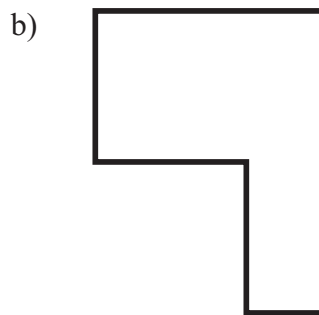
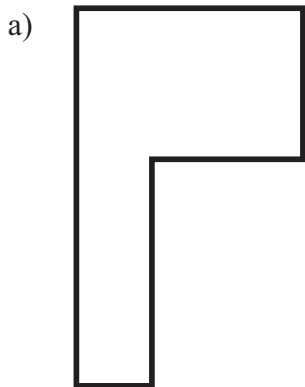



1) Write the name of each angle, below.

a) **Obtuse angle**

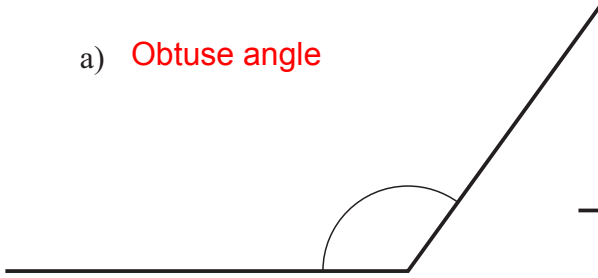

b) **Acute angle**

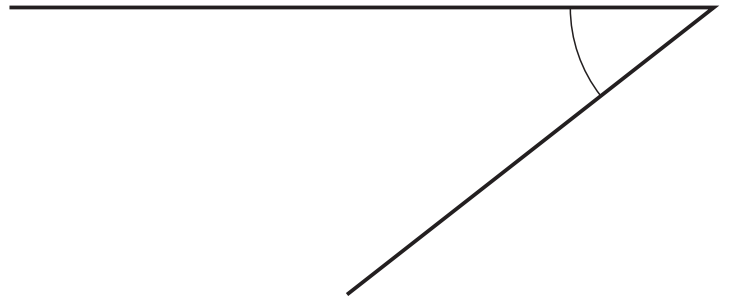

c)

**Right angle**

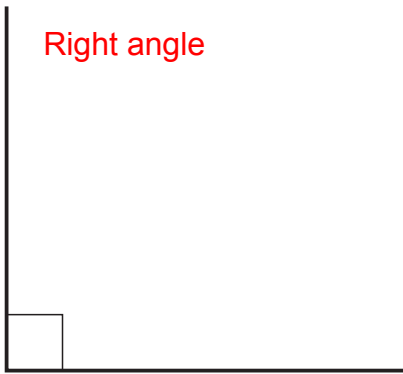

d)

**Reflex angle**

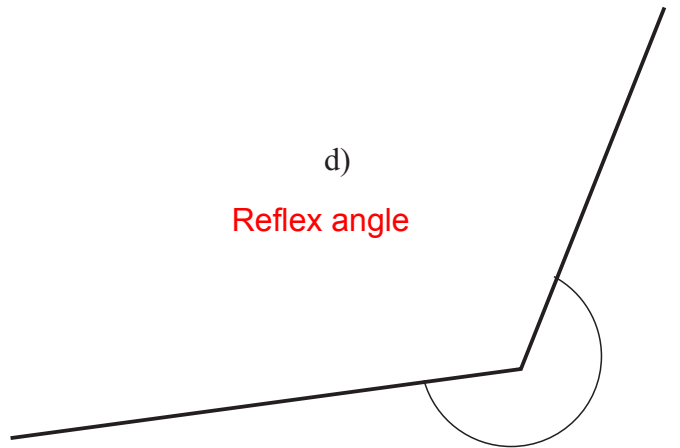

2) Draw a triangle which contains:

a) Three acute angles.



b) One obtuse angle and two acute angles.



**Other triangles are possible**

c) A right angle.



- 1) a) On the probability scale below, mark with a cross (×) the probability that it will snow in Birmingham in July.

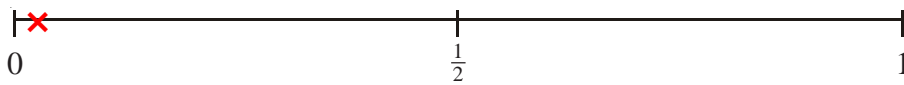

- b) On the probability scale below, mark with a cross (×) the probability that it will rain in Wales next year.

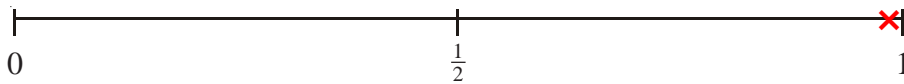

- c) On the probability scale below, mark with a cross (×) the probability that you will get a tail when you flip a fair coin.

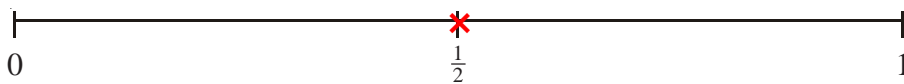

- d) On the probability scale below, mark with a cross (×) the probability that you will get a number bigger than 4 when you roll an ordinary dice.

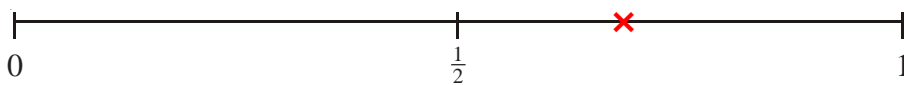

- 2) 4 jelly babies are in a bag.  
2 are red, 1 is green and 1 is black.

Without looking in the bag, a jelly baby is taken out.

- a) On the probability scale below, mark with a cross (×) the probability that the jelly baby taken from the bag is green.

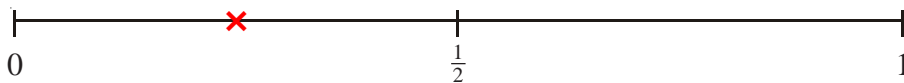

- b) On the probability scale below, mark with a cross (×) the probability that the jelly baby taken from the bag is green or black.

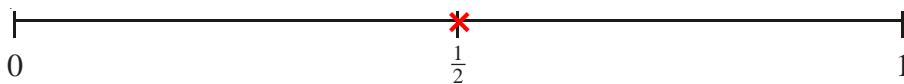

- c) On the probability scale below, mark with a cross (×) the probability that the jelly baby taken from the bag is red or black.

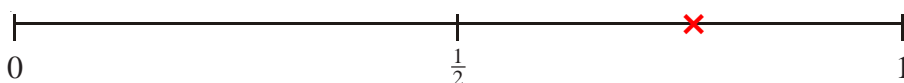

Tally Charts and Bar Charts

1) Here is a list of coins in Yvonne's purse.

5p £1 20p 1p 50p  
 10p £1 5p 50p 2p  
 5p 5p £1 1p 5p  
 £1 2p 5p 5p 2p

Coin	Tally	Frequency
1p		2
2p		3
5p		7
10p		1
20p		1
50p		2
£1		4

Complete the table for this information.

2) Tim made a note of how many minutes he spent on the internet over the period of a week. His results are as follows:

Monday 20 mins  
 Tuesday 30 mins  
 Wednesday 60 mins  
 Thursday 40 mins  
 Friday 20 mins  
 Saturday 50 mins  
 Sunday 40 mins

Draw a bar chart to show this information.

Time spent on internet

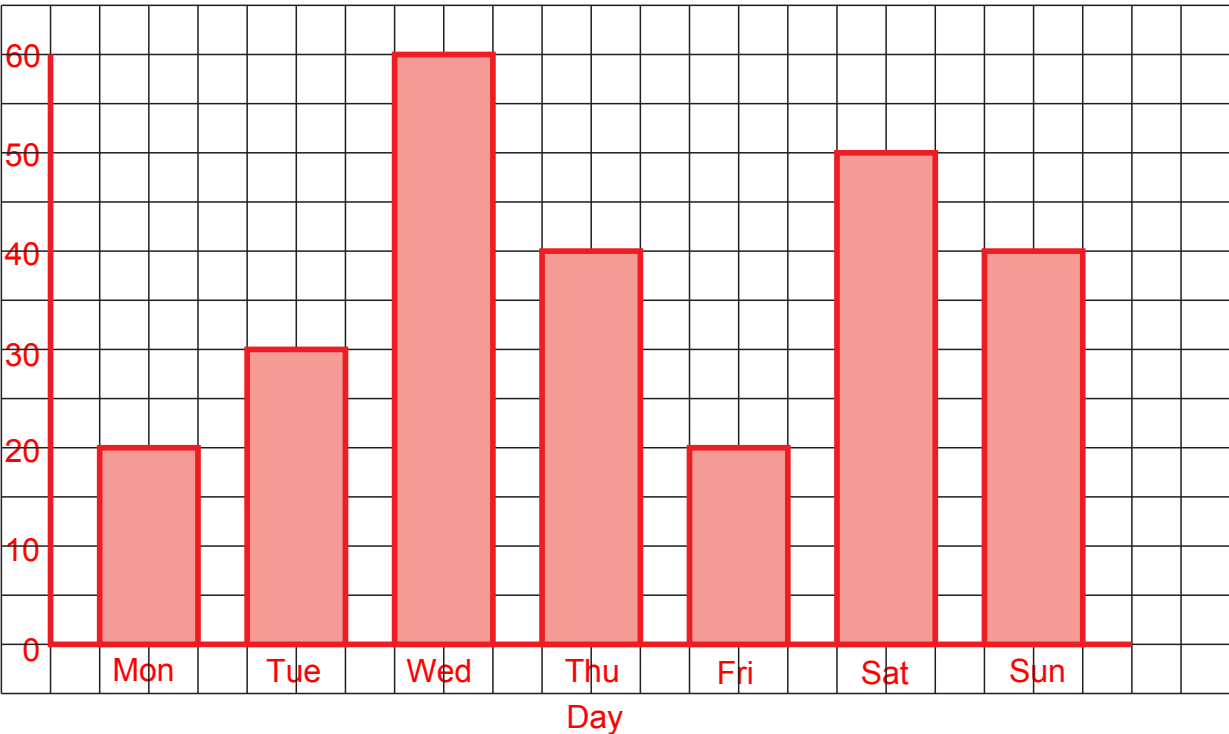

# Pictograms

- 1) The pictogram shows the number of watches sold by a shop in January, February and March.

January	
February	
March	
April	
May	

Key represents 4 watches.

- a) How many watches were sold in January? **16**  
 b) How many **more** watches were sold in March than in February? **3**

19 watches were sold in April.  
 14 watches were sold in May.

- c) Use this information to complete the pictogram.

- 2) The pictogram shows the number of DVDs borrowed from a shop on Monday and Tuesday.

Monday	
Tuesday	
Wednesday	
Thursday	

Key represents 10 DVDs.

- a) How many DVDs were borrowed on  
 (i) Monday? **40**  
 (ii) Tuesday? **25**

On Wednesday, 50 DVDs were borrowed.  
 On Thursday, 15 DVDs were borrowed.

- b) Show this information in the pictogram.

1) a) 
$$\begin{array}{r} 42 \\ + 26 \\ \hline 68 \end{array}$$
      b) 
$$\begin{array}{r} 57 \\ + 38 \\ \hline 95 \end{array}$$
      c) 
$$\begin{array}{r} 96 \\ + 75 \\ \hline 171 \end{array}$$

2) a) 
$$\begin{array}{r} 637 \\ + 961 \\ \hline 1598 \end{array}$$
      b) 
$$\begin{array}{r} 983 \\ + 442 \\ \hline 1425 \end{array}$$
      c) 
$$\begin{array}{r} 969 \\ + 758 \\ \hline 1727 \end{array}$$

3) a)  $452 + 38 = 490$       b)  $147 + 763 = 910$       c)  $813 + 431 + 38 = 1282$

4) There were two exhibitions at the NEC one Sunday.  
 3816 people went to one of the exhibitions and 13427 people  
 went to the other exhibition.  
 How many people went to the NEC, in total, on the Sunday? **17243**

5) a)  $2.6 + 1.2 = 3.8$       b)  $2.74 + 6.81 = 9.55$       c)  $45.36 + 6.81 = 52.17$

6) a)  $23 + 1.5 = 24.5$       b)  $13.6 + 38 = 51.6$       c)  $13.2 + 17.82 = 31.02$

1) a) 
$$\begin{array}{r} 78 \\ -42 \\ \hline 36 \end{array}$$

b) 
$$\begin{array}{r} 74 \\ -26 \\ \hline 48 \end{array}$$

c) 
$$\begin{array}{r} 62 \\ -39 \\ \hline 23 \end{array}$$

2) a) 
$$\begin{array}{r} 485 \\ -291 \\ \hline 194 \end{array}$$

b) 
$$\begin{array}{r} 773 \\ -486 \\ \hline 287 \end{array}$$

c) 
$$\begin{array}{r} 100 \\ -34 \\ \hline 66 \end{array}$$

3) a)  $653 - 48 = 605$

b)  $362 - 183 = 179$

c)  $2000 - 461 = 1539$

- 4) There were two films showing at a cinema one Saturday.  
 One of the films was shown in a large room and the other was in a smaller room.  
 The film in the larger room was watched by a total of 3562 people.  
 The film in the smaller room was watched by 1671 people.  
 How many more people saw the film in the larger room? **1891**

5) a)  $782 + 426 - 278 = 930$

b)  $8162 + 1149 - 799 = 8512$

1) Work out

a)  $13 \times 18$     **234**

b)  $135 \times 27$     **3645**

c)  $116 \times 41$     **4756**

d)  $264 \times 43$     **11352**

e)  $326 \times 24$     **7824**

f)  $281 \times 59$     **16579**

g)  $286 \times 48$     **13728**

h)  $428 \times 34$     **14552**

i)  $461 \times 45$     **20745**

2) “MathsWatch Travel” has 36 coaches.

Each of these coaches can carry 53 passengers.

How many passengers in total can all the coaches carry?    **1908**

3) “MathsWatch Tours” has a plane that will carry 47 passengers.

To fly from Manchester to Lyon, each passenger pays £65

Work out the total amount that the passengers pay.    **£3055**

4) A Science textbook costs £13.

Mr Jones buys a class set of 34 books.

How much do they cost him?    **£442**

5) A graphical calculator costs £18.

How much would 43 calculators cost?    **£774**

## Dividing Integers

- 1) Work out
- a)  $325 \div 5$  **65**                      d)  $377 \div 29$  **13**                      g)  $75 \div 4$  **18.75**
- b)  $448 \div 8$  **56**                      e)  $27 \div 6$  **4.5**                      h)  $135 \div 20$  **6.75**
- c)  $221 \div 13$  **17**                      f)  $123 \div 15$  **8.2**                      i)  $381 \div 12$  **31.75**
- 2) A box can hold 19 books.  
Work out how many boxes will be needed to hold 646 books. **34**
- 3) The distance from Glasgow to Paris is 1290 km.  
A flight from Glasgow to Paris lasts 3 hours.  
Given that
- $$\text{Average speed} = \frac{\text{Distance}}{\text{Time}}$$
- Work out the average speed of the aeroplane in km/h. **430 km/h**
- 4) Pencils cost 25p each.  
Mr Smith spends £15 on pencils.  
Work out the number of pencils he gets. **60**
- 5) Yesterday, Gino was paid £19.61 for delivering pizzas.  
He is paid 53p for each pizza he delivers.  
Work out how many pizzas Gino delivered yesterday. **37**
- 6) Emma sold 38 teddy bears for a total of £513  
She sold each teddy bear for the same price.  
Work out the price at which Emma sold each teddy bear. **£13.50**
- 7)
- Canal boat for hire  
£1855.00  
for 14 days
- Work out the cost per day of hiring the canal boat. **£132.50**
- 8) A teacher has £539 to spend on books.  
Each book costs £26  
How many books can the teacher buy? **20**
- 9) John delivers large wooden crates with his van.  
The weight of each crate is 68 kg.  
The greatest weight the van can hold is 980 kg.  
Work out the greatest number of crates that the van can hold. **14**



- 1) a) Which operation is the inverse of 'add'? **Subtract**  
b) Which operation is the inverse of 'divide'? **Multiply**

2) Use inverse operations to complete the second equation each time.

a)  $12 + 6 = 18$   $\longrightarrow$   $\boxed{18} - \boxed{6} = 12$

b)  $28 - 13 = 15$   $\longrightarrow$   $\boxed{15} + \boxed{13} = 28$

3) Use inverse operations to complete the second equation each time.

a)  $14 \times 2 = 28$   $\longrightarrow$   $\boxed{28} \div \boxed{2} = 14$

b)  $60 \div 12 = 5$   $\longrightarrow$   $\boxed{5} \times \boxed{12} = 60$

4) Use inverse operations to complete the second equation each time.

a)  $19 + 13 = 32$   $\longrightarrow$   $\boxed{32} - \boxed{13} = 19$

b)  $46 - 13 = 33$   $\longrightarrow$   $\boxed{33} + \boxed{13} = 46$

5) Use inverse operations to complete the second equation each time.

a)  $28 \div 7 = 4$   $\longrightarrow$   $\boxed{4} \times \boxed{7} = 28$

b)  $16 \times 3 = 48$   $\longrightarrow$   $\boxed{48} \div \boxed{16} = 3$

1) Tony buys

4 kg of potatoes at £1.60 per kilogram

and

2 kg of onions at £1.80 per kilogram.

She pays with a £20 note.

How much change should she receive? **£10**

2)

Bags of sweets
£1.50 per bag
Buy 3, get 1 free

How many bags of sweets can you buy for £9? **8**



3)

**Cinema Prices**

Adult	£2.99
Child	£2.30
Family ticket (2 adults and 2 children)	£9.00

a) 1 adult and 7 children went to the cinema.

How much did they pay altogether? **£19.09**

b) 2 adults and 2 children went to the cinema and bought a family ticket.

How much did they save altogether? **£1.58**

# Negatives in Real Life

- 1) At midnight, the temperature was  $-7^{\circ}\text{C}$ .  
 By 7am the next morning, the temperature had increased by  $6^{\circ}\text{C}$ .  
 a) Work out the temperature at 7am the next morning.  $-1^{\circ}\text{C}$

At midday, the temperature was  $3^{\circ}\text{C}$ .

- b) Work out the difference between the temperature at midday and the temperature at midnight.  $10^{\circ}\text{C}$   
 c) Work out the temperature which is halfway between  $-7^{\circ}\text{C}$  and  $3^{\circ}\text{C}$ .  $-2^{\circ}\text{C}$
- 2) The table below gives the temperature recorded on 25th December in 7 cities across the world.

City	Edinburgh	London	New York	Moscow	Paris	Rome	Cairo
Temperature	$-6^{\circ}\text{C}$	$0^{\circ}\text{C}$	$-15^{\circ}\text{C}$	$-23^{\circ}\text{C}$	$3^{\circ}\text{C}$	$5^{\circ}\text{C}$	$18^{\circ}\text{C}$

- a) Which city recorded the lowest temperature? **Moscow**
- b) What is the difference in temperature between New York and Paris?  $18^{\circ}\text{C}$
- c) What is the difference in temperature between Cairo and Edinburgh?  $24^{\circ}\text{C}$
- d) The temperature in Madrid was  $9^{\circ}\text{C}$  lower than in Rome.  
 What was the temperature in Madrid?  $-4^{\circ}\text{C}$
- e) The temperature in Mexico City was  $6^{\circ}\text{C}$  higher than in New York.  
 What was the temperature in Mexico City?  $-9^{\circ}\text{C}$
- 3) The table shows the temperature on the surface of each of five planets.

Planet	Temperature
Venus	$210^{\circ}\text{C}$
Jupiter	$-150^{\circ}\text{C}$
Saturn	$-180^{\circ}\text{C}$
Neptune	$-210^{\circ}\text{C}$
Pluto	$-230^{\circ}\text{C}$

- a) Work out the difference in temperature between Jupiter and Pluto.  $80^{\circ}\text{C}$
- b) Work out the difference in temperature between Venus and Saturn.  $390^{\circ}\text{C}$
- c) Which planet has a temperature  $30^{\circ}\text{C}$  lower than Saturn? **Neptune**

The temperature on Mars is  $90^{\circ}\text{C}$  higher than the temperature on Jupiter.

- d) Work out the temperature on Mars.  $-60^{\circ}\text{C}$

1) What fraction of each of the following shapes is shaded?

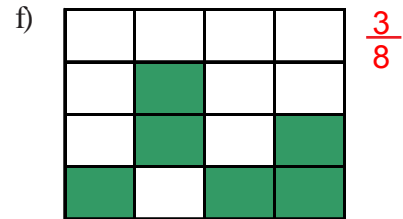
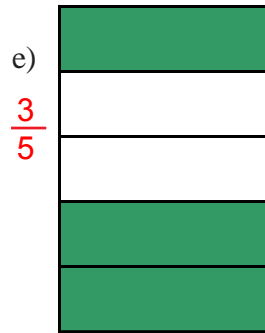
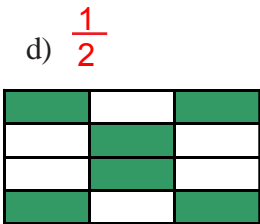
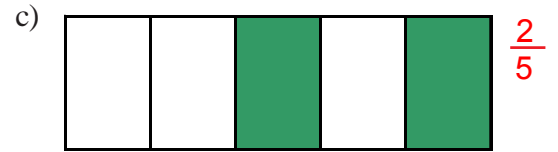
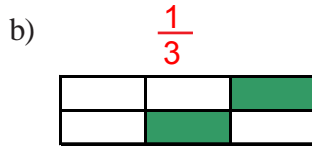
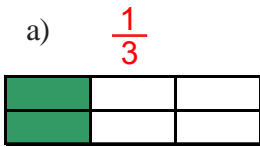

2) Shade the given fraction in the following grids.

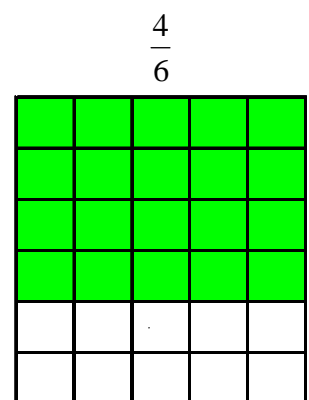
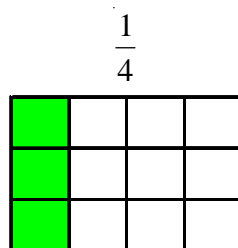
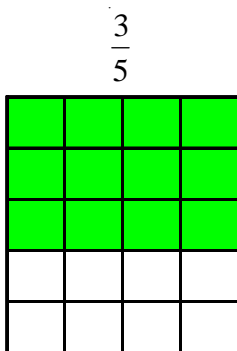

3) Which of these fractions is the smallest?

$\frac{5}{6}$  or  $\frac{7}{9}$  (use the grids to help)

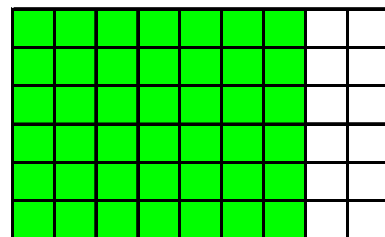
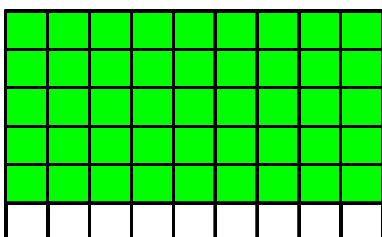

## Equivalent Fractions

- 1) Each of the grids below has a fraction written at the side of it.  
a) Shade the grids to show these fractions.

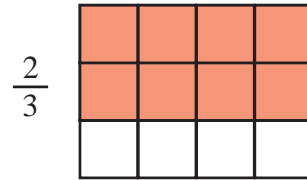
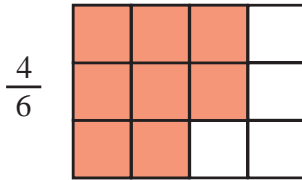
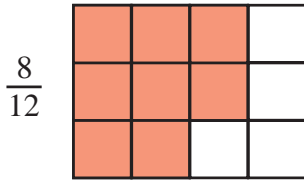

- b) What do you notice about how many little squares are shaded in each grid?

**It is always the same - 8 squares.**

- 2) Each of the grids below has a fraction written at the side of it.  
a) Shade the grids to show these fractions.

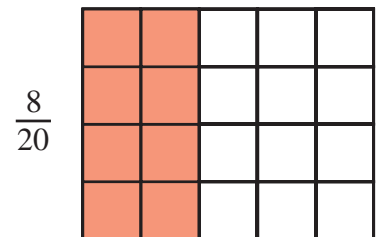
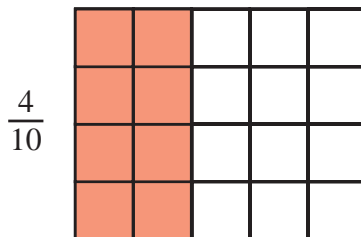
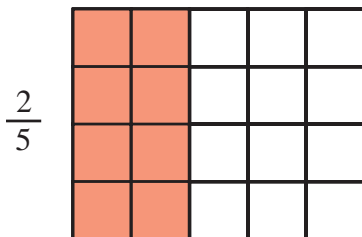

- b) What do you notice about how many little squares are shaded in each grid?

**It is always the same - 8 squares.**

- 3) Find the missing values in these equivalent fractions.

$$\frac{1}{2} = \frac{2}{\boxed{4}} = \frac{3}{\boxed{6}} = \frac{4}{\boxed{8}}$$

- 4) Find the missing values in these equivalent fractions.

$$\frac{2}{5} = \frac{6}{\boxed{15}} = \frac{\boxed{12}}{30} = \frac{14}{\boxed{35}}$$

- 5) How do you know that  $\frac{3}{7}$  is not equivalent to  $\frac{25}{56}$ ?

**You have to multiply 7 by 8 to get 56, but when you multiply 3 by 8 you get 24, not 25.**

1) Write the following fractions in their simplest forms

a)  $\frac{2}{4}$        $\frac{1}{2}$

b)  $\frac{5}{10}$        $\frac{1}{2}$

c)  $\frac{4}{6}$        $\frac{2}{3}$

d)  $\frac{6}{9}$        $\frac{2}{3}$

e)  $\frac{12}{15}$        $\frac{4}{5}$

f)  $\frac{8}{12}$        $\frac{2}{3}$

g)  $\frac{15}{20}$        $\frac{3}{4}$

2) Write the following fractions in their simplest forms

a)  $\frac{9}{30}$        $\frac{3}{10}$

b)  $\frac{14}{18}$        $\frac{7}{9}$

c)  $\frac{7}{49}$        $\frac{1}{7}$

d)  $\frac{48}{72}$        $\frac{2}{3}$

e)  $\frac{60}{75}$        $\frac{4}{5}$

f)  $\frac{15}{27}$        $\frac{5}{9}$

g)  $\frac{72}{96}$        $\frac{3}{4}$

1) Write down the number which is in the middle of:

a) 3 and 9     **6**

b) 12 and 28     **20**

c) 11 and 22     **16.5**

d) 17 and 32     **24.5**

e) 72 and 108     **90**

f) 1 and 100     **50.5**

g) -6 and 2     **-2**



2) Write down the number which is in the middle of:

a) 2.4 and 6.8     **4.6**

b) 5.9 and 12.5     **9.2**

c) -5 and 7.8     **1.4**



3) a) 7 is in the middle of 3 and which other number?     **11**

b) 16 is in the middle of 9 and which other number?     **23**

c) 2.4 is in the middle of 1.1 and which other number?     **3.7**

1) Write the factors of

a) 6

1, 2, 3, 6

b) 16

1, 2, 4, 8, 16

c) 18

1, 2, 3, 6, 9, 18

d) 30

1, 2, 3, 5, 6, 10, 15, 30

2) In a pupil's book the factors of 12 are listed as

1 2 3 4 ~~8~~ 12  
6

The above list contains a mistake.

Cross it out from the list and replace it with the correct number.

3) The factors of 30 and 40 are listed

**30:** 1, 2, 3, 5, 6, 10, 15, 30

**40:** 1, 2, 4, 5, 8, 10, 20, 40

Write the common factors of 30 and 40 (the numbers that are factors of 30 and 40).

1, 2, 5, 10

4) Write the first four multiples of

a) 3

3, 6, 9, 12

b) 5

5, 10, 15, 20

c) 10

10, 20, 30, 40

d) 15

15, 30, 45, 60

5) In a pupil's book the first 7 multiples of 8 are listed as

8 16 ~~22~~ 32 40 48 ~~54~~  
24 56

The above list contains 2 mistakes.

Cross them out and replace them with the correct numbers.

6) The first five multiples of 4 and 10 are listed

**4:** 4, 8, 12, 16, 20

**10:** 10, 20, 30, 40, 50

From the two lists above, write the common multiple of 4 and 10.

20

7) List the first five prime numbers

2, 3, 5, 7, 11

8) Using just this list of numbers:

11 18 1 4 21 24 9 3 12 2 19

find the following:

a) The prime numbers 11, 3, 2, 19

b) The factors of 18 18, 1, 9, 3, 2

c) The multiples of 3 18, 21, 24, 9, 3, 12



1) Write the following using indices:

eg.  $3 \times 3 \times 3 \times 3 = 3^4$

a)  $2 \times 2 \times 2 \times 2 = 2^4$

d)  $12 \times 12 \times 12 \times 12 \times 12 = 12^5$

b)  $4 \times 4 \times 4 = 4^3$

e)  $3.6 \times 3.6 = 3.6^2$

c)  $5 \times 5 \times 5 \times 5 \times 5 \times 5 = 5^6$

f)  $5.2 \times 5.2 \times 5.2 = 5.2^3$

2) Write each of the following as a single power:

eg.  $5^2 \times 5^4 = 5^6$

a)  $6^2 \times 6^3 = 6^5$

d)  $5^3 \times 5 = 5^4$

b)  $7^4 \times 7^2 = 7^6$

e)  $2^9 \times 2^3 = 2^{12}$

c)  $9^3 \times 9^6 = 9^9$

f)  $7.2^3 \times 7.2^2 = 7.2^5$

3) Write each of the following as a single power:

eg.  $7^5 \div 7^2 = 7^3$

a)  $9^5 \div 9^3 = 9^2$

d)  $\frac{7^8}{7^3} = 7^5$

b)  $6^9 \div 6^5 = 6^4$

e)  $\frac{3^6}{3} = 3^5$

c)  $11^7 \div 11^2 = 11^5$

f)  $\frac{8^{15}}{8^4} = 8^{11}$

4) Write each of the following as a single power:

eg.  $\frac{7^3 \times 7^8}{7^6} = \frac{7^{11}}{7^6} = 7^5$

a)  $\frac{4^7 \times 4^3}{4^6} = 4^4$

b)  $\frac{9^2 \times 9^6}{9^4} = 9^4$

5) Match together cards with the same answer

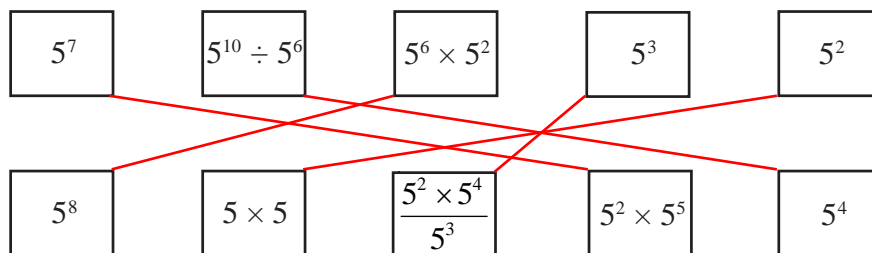

## Multiply and Divide by Powers of 10

1) Multiply the following numbers by 10, 100 and 1000:

		<b>×10</b>	<b>×100</b>	<b>×1000</b>
<i>e.g.</i>	21	210	2100	21000
	9	90	900	9 000
	63	630	6 300	63 000
	845	8 450	84 500	845 000
	3.65	36.5	365	3 650
	0.4	4	40	400
	1.324	13.24	132.4	1 324

---

2) Divide the following numbers by 10, 100 and 1000:

		<b>÷10</b>	<b>÷100</b>	<b>÷1000</b>
<i>e.g.</i>	21	2.1	0.21	0.021
	9	0.9	0.09	0.009
	63	6.3	0.63	0.063
	845	84.5	8.45	0.845
	3.65	0.365	0.0365	0.00365
	0.4	0.04	0.004	0.0004
	1.324	0.1324	0.01324	0.001324

---

3) Work out the following:

$$3 \times 100 = 300$$

$$65 \times 10 = 650$$

$$17 \div 10 = 1.7$$

$$359 \times 10 = 3\,590$$

$$0.5 \div 100 = 0.005$$

$$2.3 \times 1000 = 2\,300$$

$$42 \div 100 = 0.42$$

$$3582 \div 100 = 35.82$$

$$0.9 \times 10 = 9$$

$$3.645 \times 100 = 364.5$$

$$88 \div 1000 = 0.088$$

$$39.62 \times 1000 = 39\,620$$

1) Round these numbers to the nearest 10:

- a) 26      **30**
- b) 62      **60**
- c) 75      **80**
- d) 231     **230**
- e) 797     **800**
- f) 5842    **5 840**
- g) 9875    **9 880**
- h) 13758   **13 760**

2) Round these numbers to the nearest 100:

- a) 78      **100**
- b) 223     **200**
- c) 549     **500**
- d) 1450    **1 500**
- e) 1382    **1 400**
- f) 4537    **4 500**
- g) 9193    **9 200**
- h) 17625   **17 600**

3) Round these numbers to the nearest 1000:

- a) 850     **1 000**
- b) 1455    **1 000**
- c) 3230    **3 000**
- d) 7500    **8 000**
- e) 8455    **8 000**
- f) 9690    **10 000**
- g) 12390   **12 000**
- h) 28910   **29 000**

- 1) Round the following numbers to 1 decimal place
  - a) 13.681  
**13.7**
  - b) 344.7234  
**344.7**
  - c) 0.76133  
**0.8**
  
- 2) Round the following numbers to 2 decimal places
  - a) 58.8136  
**58.81**
  - b) 14.22731  
**14.23**
  - c) 203.86884  
**203.87**
  
- 3) Round the following numbers to 1 decimal place
  - a) 48.9732  
**49.0**
  - b) 163.9299  
**163.9**
  - c) 19.952  
**20.0**
  
- 4) Round the following numbers to 2 decimal places
  - a) 10.697  
**10.70**
  - b) 8.993  
**8.99**
  - c) 14.9964  
**15.00**
  
- 5) Work out the answer to  $2.6882 \times 14.71728$  and give your answer correct to 2 decimal places. **39.56**
  
- 6) Work out the answer to  $64.2 \div 5.7$  and give your answer correct to 1 decimal place. **11.3**
  
- 7) Work out the answer to  $4.74^2$  giving your answer correct to 2 decimal places. **22.47**
  
- 8) Find the answer to  $\sqrt{17.3}$  giving your answer correct to 1 decimal place. **4.2**

## Simplifying - Addition and Subtraction

1) Simplify the following

a)  $x + x = 2x$

b)  $2x + 3x = 5x$

c)  $5t - 3t = 2t$

d)  $7y - 6y = y$

e)  $x + 2x + 3x = 6x$

f)  $3g - g + 6g = 8g$

g)  $2x - 7x + 8x = 3x$

h)  $y - 2y - 3y + 6y = 2y$

2) Simplify the following

a)  $xy + 3xy = 4xy$

b)  $5xy - 2xy = 3xy$

c)  $4x^2y + x^2y = 5x^2y$

d)  $3xy^2 - 2xy^2 = xy^2$

e)  $2x^2y^3 + 4x^2y^3 - 3x^2y^3 = 3x^2y^3$

f)  $6a^2bc^4 + 5a^2bc^4 - 2a^2bc^4 = 9a^2bc^4$

3) Simplify the following

a)  $x + y + x + y = 2x + 2y$

b)  $2x + 3y + x + 4y = 3x + 7y$

c)  $2a + 4b - a + 2b = a + 6b$

d)  $3x + 4y - x - 2y = 2x + 2y$

e)  $6x - 2y + 2x + 5y = 8x + 3y$

f)  $4x - 3y - 2x - 5y = 2x - 8y$

g)  $3t + 4u + 2t - 7u = 5t - 3u$

h)  $2xy + 3t - xy - 4t = xy - t$

## Simplifying - Multiplication

1) Simplify the following

a)  $x \times x = x^2$

b)  $x \times x \times x \times x \times x = x^5$

c)  $y \times y \times y = y^3$

2) Simplify the following

a)  $x^2 \times x^4 = x^6$

b)  $x^3 \times x^5 = x^8$

c)  $y \times y^3 = y^4$

d)  $x^2 \times x \times x^4 = x^7$

e)  $y^2 \times y^3 \times y^4 = y^9$

3) Simplify the following

a)  $2x \times x = 2x^2$

b)  $4x \times 3x = 12x^2$

c)  $3t^2 \times 2t = 6t^3$

d)  $4y^2 \times 3y^3 = 12y^5$

e)  $x \times 2x^2 \times 3x^3 = 6x^6$

4) Simplify the following

a)  $x \times y = xy$

b)  $2x \times 3y = 6xy$

c)  $5r \times 2s \times 3t = 30rst$

d)  $6x \times 2y \times z = 12xyz$

5) Simplify the following

a)  $3x \times y = 3xy$

b)  $4x^2y \times 2x = 8x^3y$

c)  $3xy^2 \times 2xy^3 = 6x^2y^5$

d)  $6xy \times x^2y^3 \times 2y = 12x^3y^6$

e)  $2x^2y^3 \times 5x^4y^2 = 10x^6y^5$

f)  $tu^2 \times t^2u \times 4tu = 4t^4u^4$

1) Simplify the following

a)  $x^5 \div x$   $x^4$

b)  $y^4 \div y^3$   $y$

c)  $g^8 \div g^5$   $g^3$

d)  $y^4 \div y^2$   $y^2$

e)  $x^3 \div x^3$   $1$

2) Simplify the following

a)  $6x^4 \div x$   $6x^3$

b)  $12y^5 \div 3y^2$   $4y^3$

c)  $10g^7 \div 2g^5$   $5g^2$

3) Simplify the following

a)  $\frac{x^6}{x^2}$   $x^4$

b)  $\frac{x^9}{x^4}$   $x^5$

c)  $\frac{6x^8}{2x^6}$   $3x^2$

4) Simplify the following

a)  $\frac{x^6 \times x^3}{x^4}$   $x^5$

b)  $\frac{x^3 \times x^4}{x^2 \times x}$   $x^4$

c)  $\frac{(x+5)^5}{(x+5)^2}$   $(x+5)^3$

5) Simplify the following

a)  $20x^6 \div 5x^2$   $4x^4$

b)  $\frac{14x^7}{2x^2}$   $7x^5$

c)  $\frac{8x \times 2x^3}{4x^2}$   $4x^2$

## Simplifying

1) a) Simplify  $4p \times 6q$   $24pq$

b) Simplify  $d \times d \times d \times d$   $d^4$

c) Simplify  $t^9 \div t^4$   $t^5$

2) a) Simplify  $4a + 3c - 2a + c$   $2a + 4c$

b) Simplify  $2x - 6c - x + 2c$   $x - 4c$

3) a) Simplify  $5xt + 2xt - 4xt$   $3xt$

b) Simplify  $4x + 3y - 2x + 4y$   $2x + 7y$

c) Simplify  $m \times m \times m$   $m^3$

d) Simplify  $3n \times 2t$   $6nt$

4) Simplify  $3x^2 \times 4x^5y^4$   $12x^7y^4$

5) Simplify  $4x + 3y - 2x + 6y$   $2x + 9y$

6) a) Simplify  $t^4 \times t^5$   $t^9$

b) Simplify  $a \times a \times a$   $a^3$

7) a) Simplify  $x^6 \times x^2$   $x^8$

b) Simplify  $10x^2y^4 \div 2xy^2$   $5xy^2$

8) a) Simplify  $3a + 5c - a + 3c$   $2a + 8c$

b) Simplify  $x^3 \times x^4$   $x^7$

c) Simplify  $4x^2y^4 \times 5xy^2$   $20x^3y^6$

9) Simplify  $6x + 8y + 2x - 10y$   $8x - 2y$

10) a) Simplify  $x \times x \times x \times x$   $x^4$

b) Simplify  $2x \times 3y$   $6xy$

11) a) Simplify  $pq + 2pq$   $3pq$

b) Simplify  $5x + 3y - x - 4y$   $4x - y$

12) a) Simplify  $6a + 5b - 3b + a$   $7a + 2b$

b) Simplify  $x^4 + x^4$   $2x^4$

13) a) Simplify  $x + y + x + y + x$   $3x + 2y$

b) Simplify  $t^2 + t^2 + t^2$   $3t^2$

14) a) Simplify  $a^3 \times a^3$   $a^6$

b) Simplify  $\frac{3x^2y \times 4xy^3}{2xy^2}$   $6x^2y^2$

15) a) Simplify  $3d + e - d + 4e$   $2d + 5e$

b) Simplify  $3x^2 - x^2$   $2x^2$

c) Simplify  $5t + 8d - 2t - 3d$   $3t + 5d$

d) Simplify  $\frac{(3x + 1)^3}{(3x + 1)}$   $(3x + 1)^2$



1) Complete the table for the function machine.

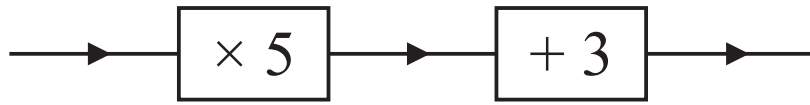

In	Out
4	23
7	38
9	48
14	73

2) Complete the table for the function machine.



In	Out
-2	-15
1	-3
6	17
$x$	$4x - 7$

3) Complete the table for the function machine.



In	Out
-3	-6
0	12
9	66
$x$	$6(x + 2)$

- 1) Write the first 5 terms of each of these sequences.
- a) Start at 2 and add 6. **2, 8, 14, 20, 26**
  - b) Start at 14 and subtract 3. **14, 11, 8, 5, 2**
  - c) Start at 4 and subtract 7. **4, -3, -10, -17, -24**
  - d) Start at 2 and multiply by 3. **2, 6, 18, 54, 162**
  - e) Start at 64 and divide by 2. **64, 32, 16, 8, 4**
  - f) Start at 600 and divide by 10. **600, 60, 6, 0.6, 0.06**
- 2) Find the term to term rule for each of these sequences.
- a) 4, 7, 10, 13, 16 **Add 3**
  - b) 15, 13, 11, 9, 7 **Subtract 2**
  - c) 2, -3, -8, -13, -18 **Subtract 5**
  - d) 7, 14, 28, 56, 112 **Multiply by 2**
  - e) 100, 10, 1, 0.1, 0.01 **Divide by 10**

1) Write the following ratios in their simplest form:

a)  $6 : 9$        $2 : 3$

b)  $10 : 5$        $2 : 1$

c)  $7 : 21$        $1 : 3$

d)  $4 : 24$        $1 : 6$

e)  $12 : 40$        $3 : 10$

f)  $4 : 2 : 8$        $2 : 1 : 4$

g)  $18 : 63 : 9$        $2 : 7 : 1$

2) Write the missing value in these equivalent ratios:

a)  $3 : 5 = 12 : \boxed{20}$

b)  $4 : 9 = \boxed{12} : 27$

c)  $\boxed{8} : 7 = 16 : 14$

3) The ratio of girls to boys in a class is  $4 : 5$ .

What fraction of the class are girls?       $\frac{4}{9}$

4) A model of a plane is made using a scale of  $1 : 5$ .

a) If the real length of the plane is 20 m, what is the length of the model?       $4 \text{ m}$

b) If the wings of the model are 1.2 m long, what is the actual length of the wings on the plane?       $6 \text{ m}$

## Using Ratio for Recipe Questions

- 1) Here are the ingredients needed to make 8 pancakes.  
James makes 24 pancakes.

<b>Pancakes</b>
Ingredients to make <b>8</b> pancakes
250 ml milk
1 egg
140 g flour
5 g butter

- a) Work out how much milk he needs. **750 ml**

Kate makes 12 pancakes.

- b) Work out how much flour she needs. **210 g**



- 2) Here are the ingredients for making fish pie for 6 people.

<b>Fish pie for 6 people</b>
180 g flour
240 g fish
80 g butter
4 eggs
180 ml milk

Jill makes a fish pie for 3 people.

- a) Work out how much flour she needs. **90 g**

Tim makes a fish pie for 15 people.

- b) Work out how much milk he needs. **450 ml**



- 3) Here are the ingredients for making pineapple sorbet for 6 people.

<b>Pineapple sorbet for 6 people</b>
800 g of pineapple
4 egg whites
½ lemon
100 g caster sugar

Trevor makes pineapple sorbet for 18 people.

- a) Work out how much caster sugar he uses. **300 g**

Sid makes a pineapple sorbet.

He uses 2 lemons.

- b) Work out how many people he makes pineapple sorbet for. **24 people**

1) What percentage of this grid is shaded?

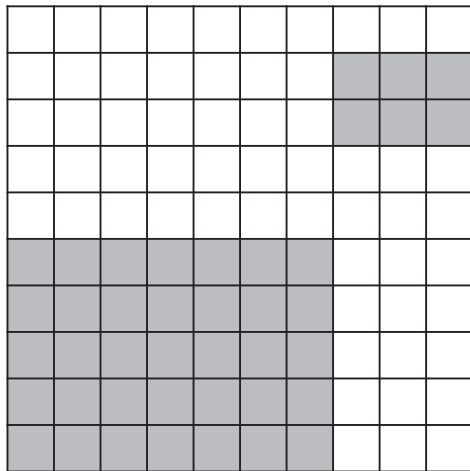

47%

2) What percentage of this grid is shaded?

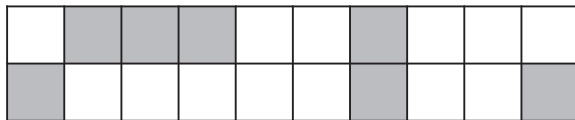

35%

3) a) What percentage of this grid is shaded?

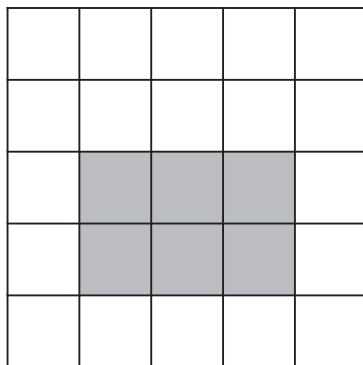

24%

b) How many more squares should be shaded to make 80% of the grid shaded? 14

4) What percentage of this grid is shaded?

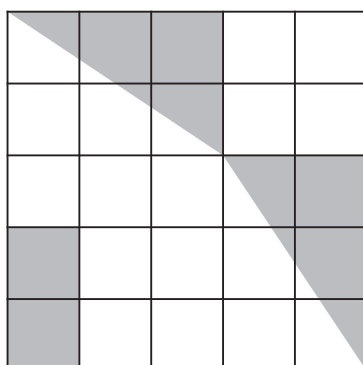

32%

1) Which of the following offer better value for money?

*Working must be shown*

a) 200ml of toothpaste for 50p or 400ml of toothpaste for 90p

$$50 \div 200 = 0.25$$

$$90 \div 400 = 0.225$$

b) 600g of bananas for 70p or 200g of bananas for 22p

$$70 \div 600 = 0.1167$$

$$22 \div 200 = 0.11$$

c) 2 litres of paint for £1.60 or 5 litres of paint for £3.50

$$1.60 \div 2 = 0.8$$

$$3.50 \div 5 = 0.7$$

d) 60 teabags for £1.62 or 40 teabags for £0.96

$$1.62 \div 60 = 0.027$$

$$0.96 \div 40 = 0.049$$



2) Which of these is the best buy?

20 exercise books  
for £4.00

$$400 \div 20 = 20$$

20p per book

35 exercise books  
for £7.80

$$780 \div 35 = 22.3$$

22p per book

3) Hamza needs to buy 2 litres of paint.

At the shop he gets two choices:

500ml for £2.55 or 1 litre for £4.79.

$$2.55 \div 500 = 0.0051$$

$$4.79 \div 1000 = 0.00479$$

a) Work out which of these would be the best buy for Hamza.

**1 litre of paint for £4.79**

b) How much does he save if he buys the 'best buy' rather than the 'worst buy'?

**£0.62 or 62p**

You must show all your working.

$$4 \times 2.55 = 10.20$$

$$10.20 - 9.58 = 0.62$$

$$2 \times 4.79 = 9.58$$



4) Honey pots are sold in two sizes.

A small pot costs 45p and weighs 450g.

$$45 \div 450 = 0.1 \text{ p per g}$$



A large pot costs 80p and weighs 850g.

$$80 \div 850 = 0.09 \text{ p per g}$$

Which pot of honey is better value for money?

You must show all your working.

**Large pot at 80p for 850g**

- 1) 8 bananas cost £4  
Work out the cost of 5 bananas.    **£2.50**
  
- 2) Emily bought 4 identical pairs of socks for £3.60  
Work out the cost of 9 pairs of these socks.    **£8.10**
  
- 3) The price of 36 chocolates is £7.20  
Work out the cost of 8 chocolates.    **£1.60**
  
- 4) Theresa bought 5 theatre tickets for £60  
Work out the cost of 9 theatre tickets.    **£108**
  
- 5) Jenny buys 4 folders.  
The total cost of these 4 folders is £6.40  
Work out the total cost of 7 of these folders.    **£11.20**
  
-  6) The cost of 15 litres of petrol is £12  
Work out the cost of 20 litres of petrol.    **£16**
  
-  7) 3 maths books cost £7.47  
Work out the cost of 5 of these.    **£12.45**
  
- 8) 1 person can cut a large area of grass in 5 hours.  
How long would it take 2 people to cut the grass?    **2.5 hours**
  
- 9) 5 people take 12 hours to build a wall.  
How long would it take 3 people to build the wall?    **20 hours**
  
- 10) 9 people can paint a bridge in 5 hours.  
How long would it take 2 people to paint the bridge?    **22.5 hours**

1) Draw a sketch of each of the following solids:

- a) A cube.
- b) A cylinder.

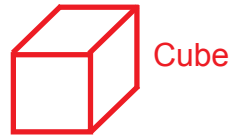

2) Write down the mathematical name of each of these 3-D shapes.

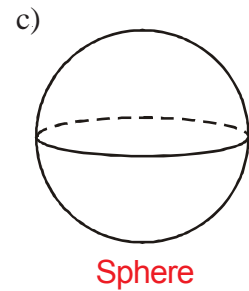
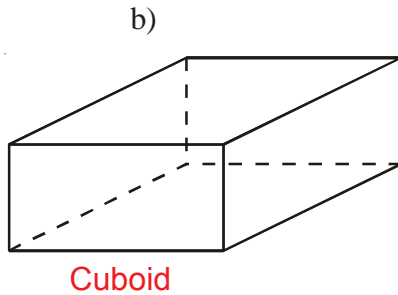
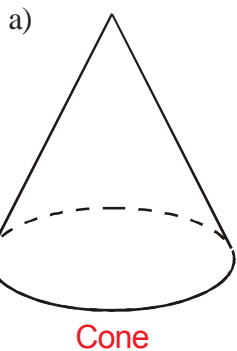

3) Look at this solid.

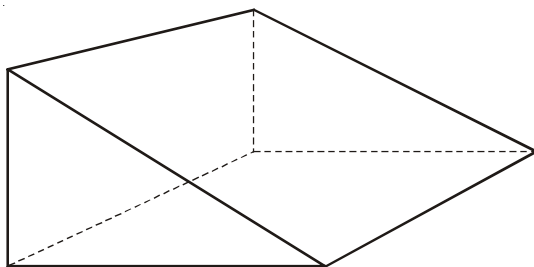

- a) What is its name? **Triangular prism**
- b) How many vertices does it have? **6**
- c) How many edges are there? **9**
- d) How many faces does it have? **5**

4) This is a picture of a pentagonal prism.

- a) How many faces does it have? **7**
- b) How many edges does it have? **15**
- c) How many vertices does it have? **10**

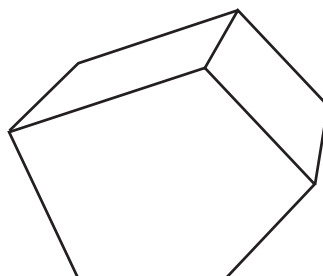



Nets

1) Sketch nets of these solids.

a)

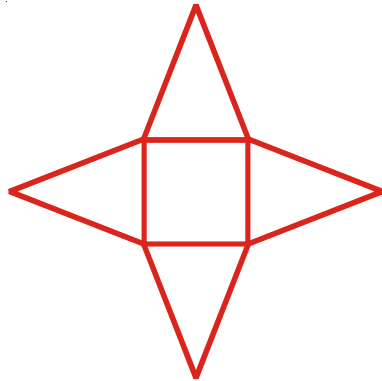
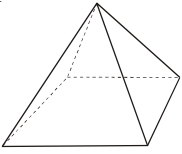

b)

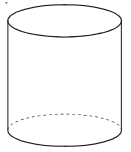
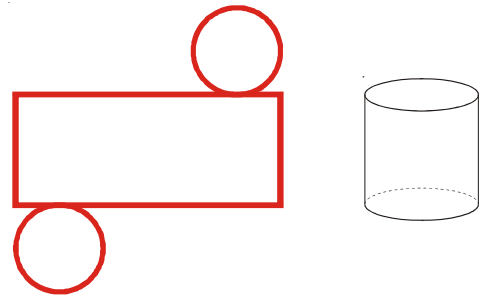

2)

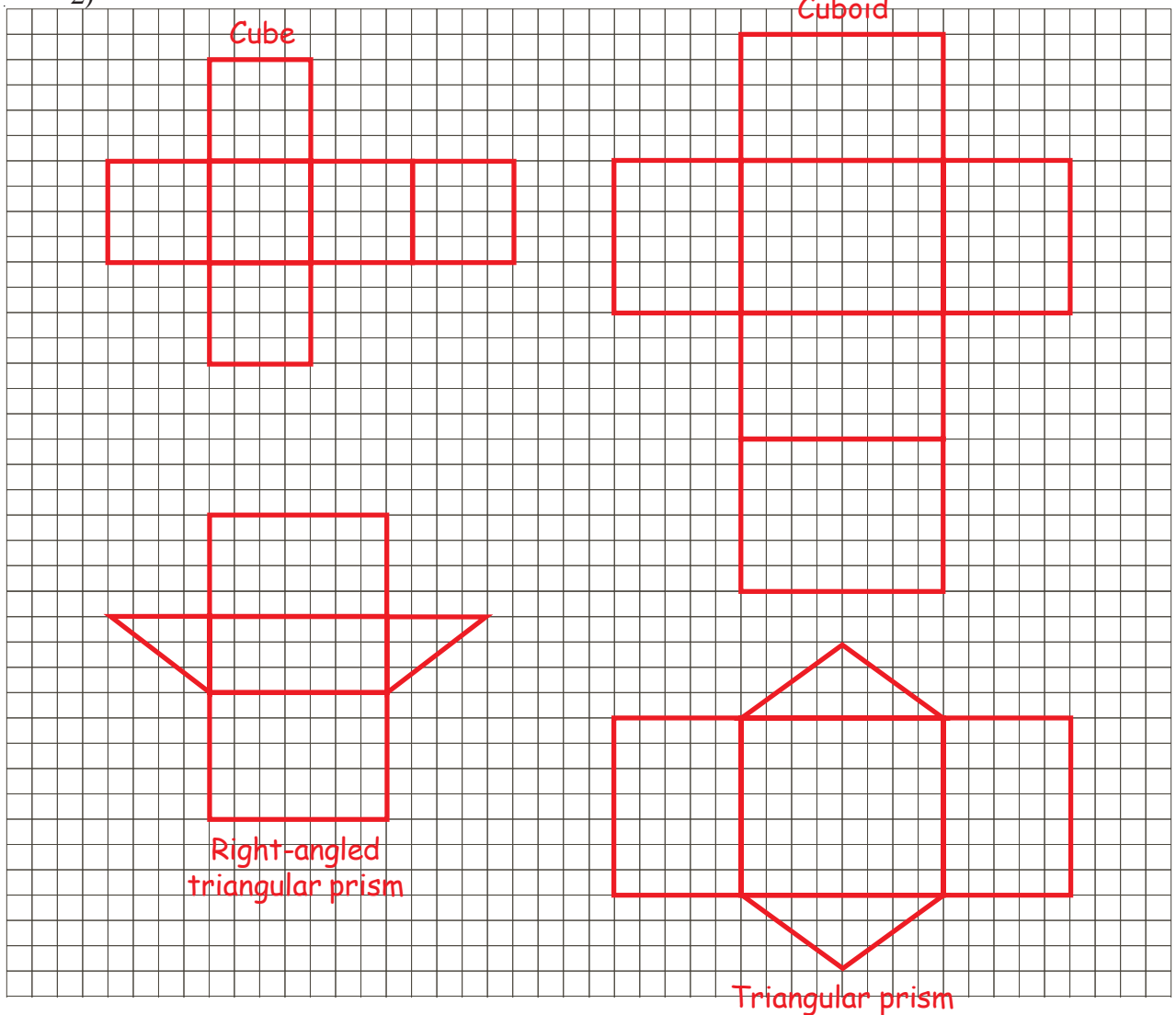

3) The two nets, below, are folded to make cubes.

Two other vertices will meet at the the dot, A. Mark them with As.  
One other vertex will meet at the dot B. Mark it with B.

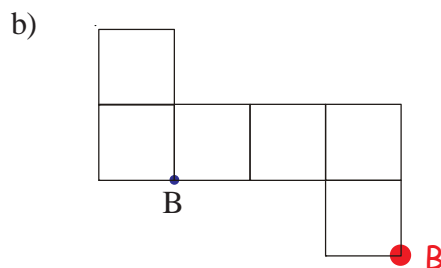
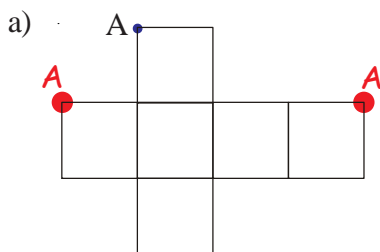

## Angles on a Line and at a Point

1) Work out the values of the unknown angles.

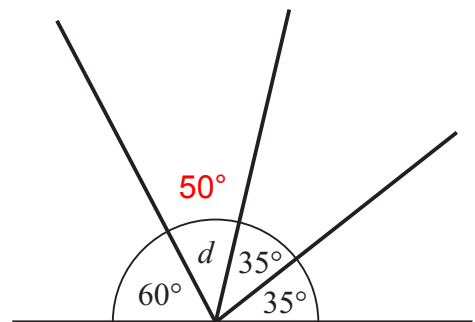
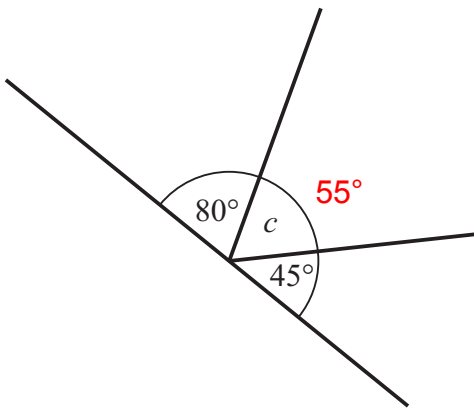
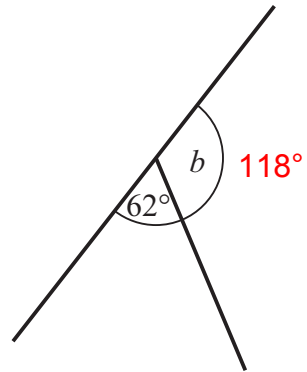
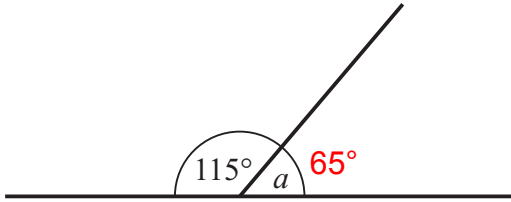

2) Work out the values of the unknown angles.

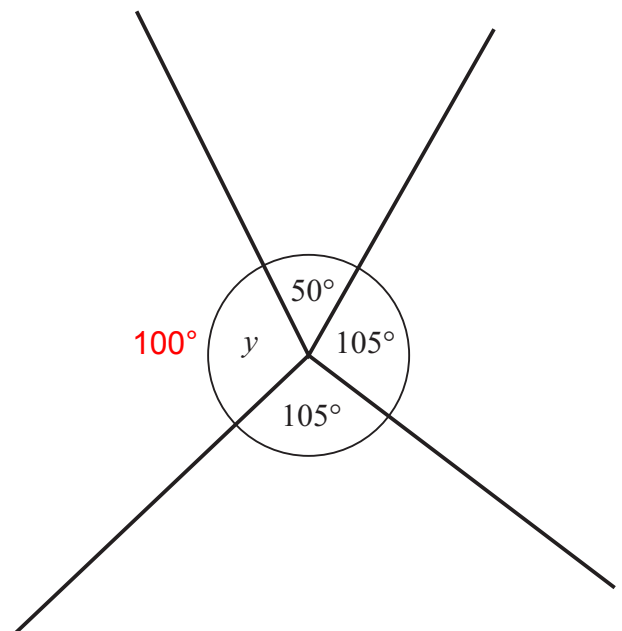
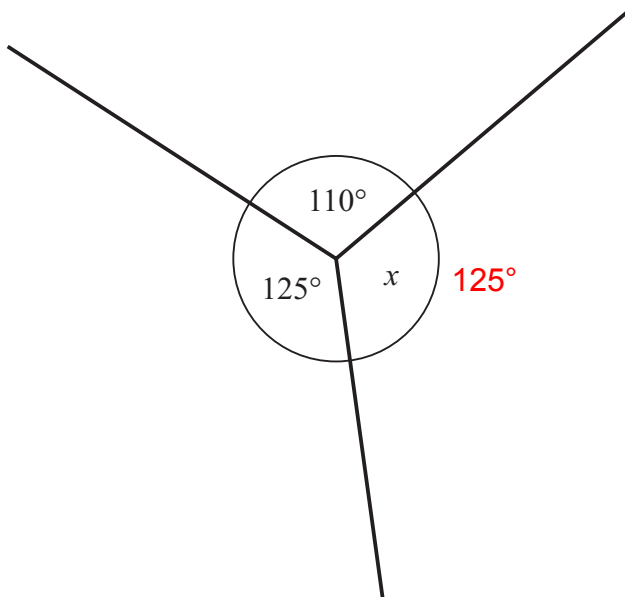

# Measuring and Drawing Angles

1) Measure the following angles:

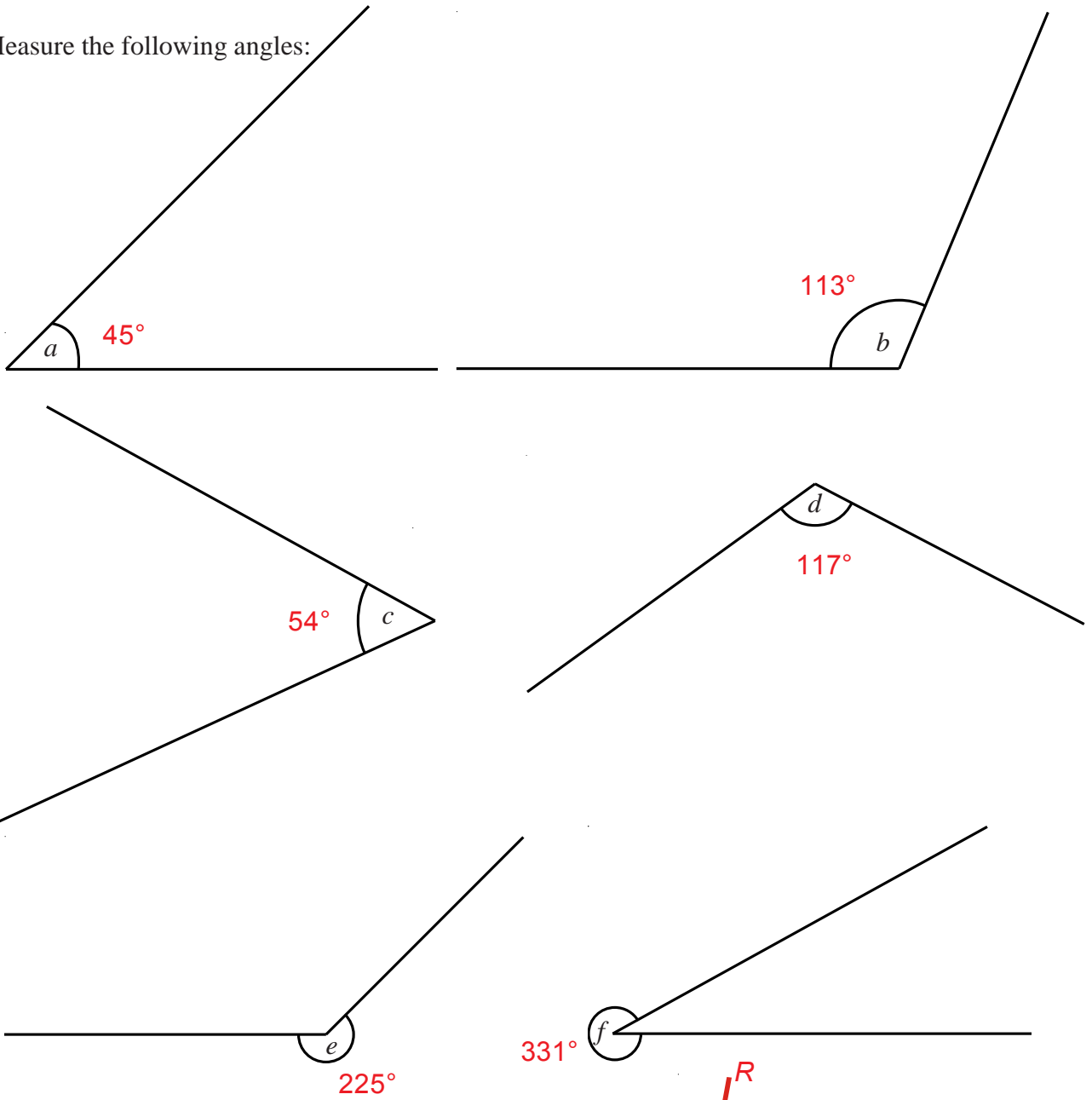

2) Draw the following angles:

a) Angle  $ABC = 60^\circ$

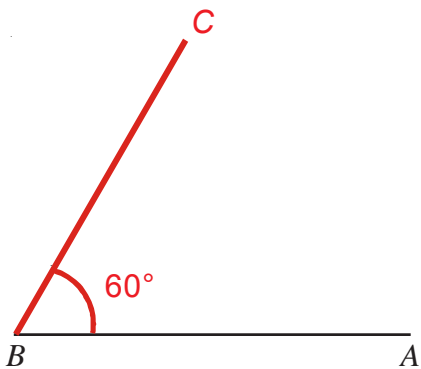

b) Angle  $PQR = 127^\circ$

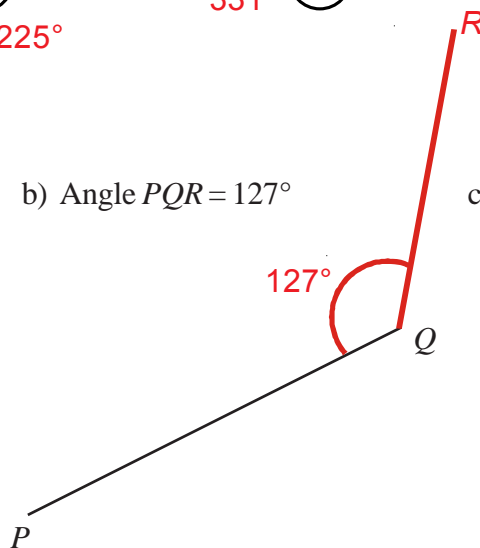

c) Angle  $XYZ = 275^\circ$

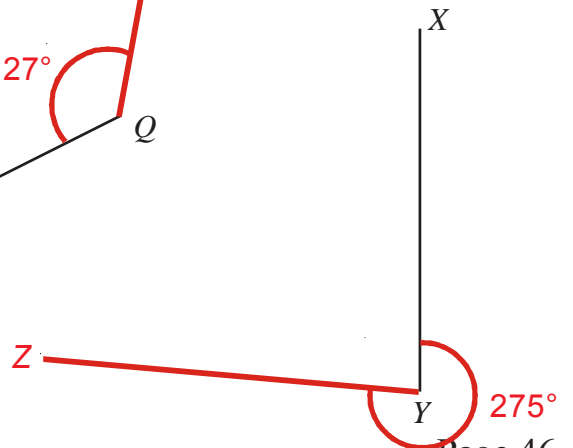

## Drawing a Triangle Using a Protractor

- 1) The diagram shows a sketch of triangle  $ABC$ .

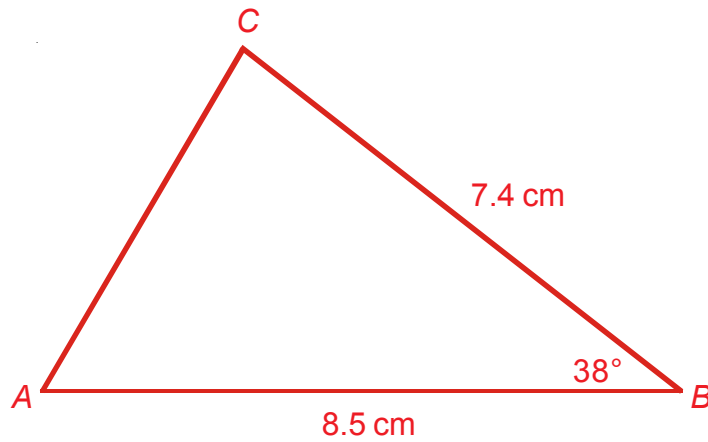

$BC = 7.4$  cm  
 $AC = 8.5$  cm  
Angle  $C = 38^\circ$

- a) Make an accurate drawing of triangle  $ABC$ .  
b) Measure the size of angle  $A$  on your diagram. Angle  $A = 59^\circ$

- 2) The diagram shows a sketch of triangle  $PQR$ .

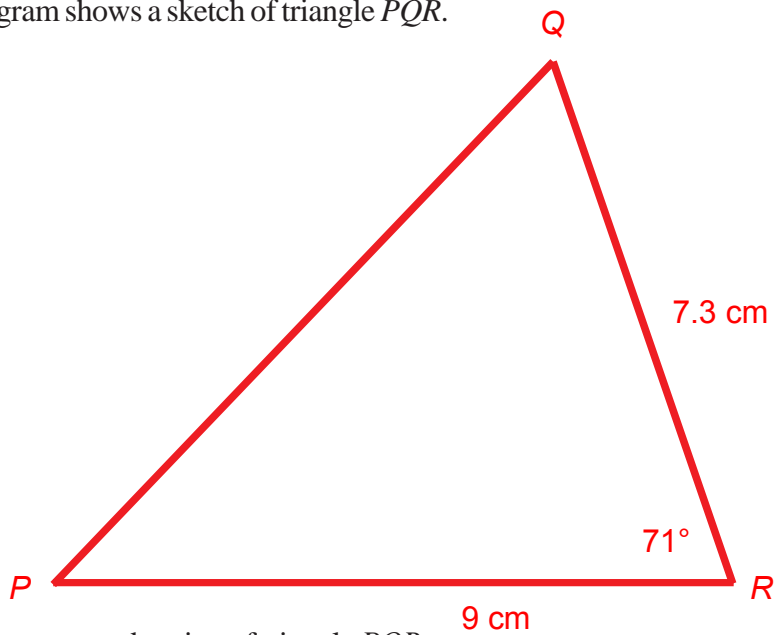

Make an accurate drawing of triangle  $PQR$ .

# Reflections

- 1) a) Reflect triangle T in the  $x$  axis.  
Label your new triangle U.
- b) Reflect triangle T in the line with equation  $y = -x$ .  
Label your new triangle V.

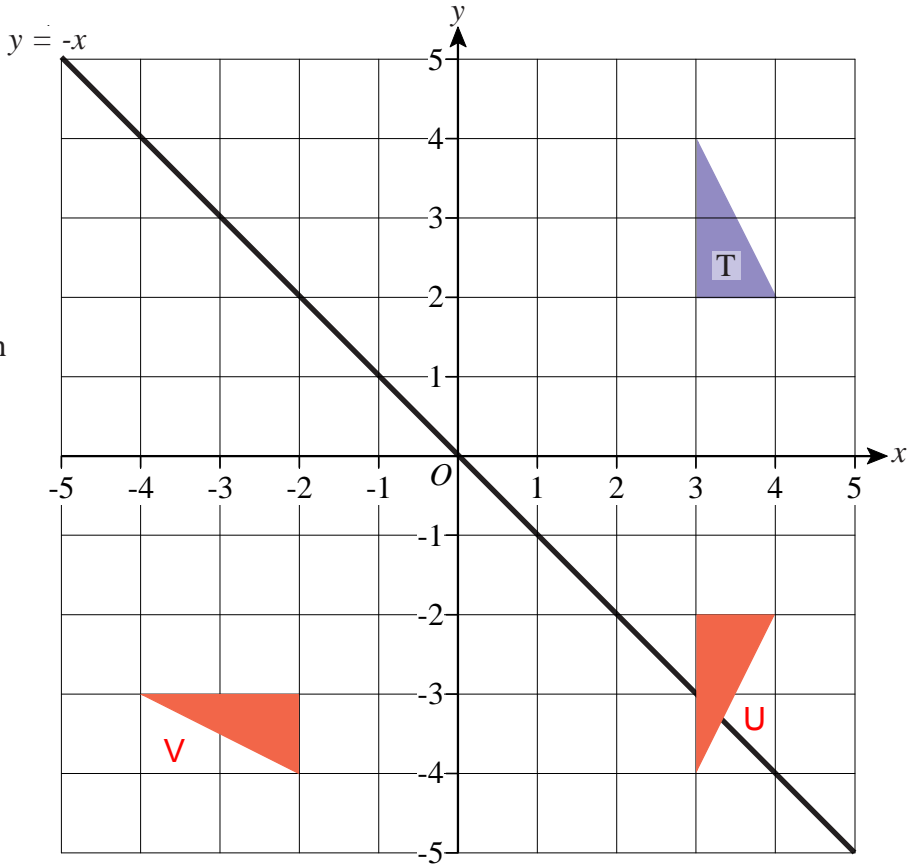

- 2) a) Describe fully the single transformation which maps triangle T to triangle U.  
**Reflection in the  $x$  axis.**
- b) Describe fully the single transformation which maps triangle T to triangle V.  
**Reflection in the line  $y = x$ .**

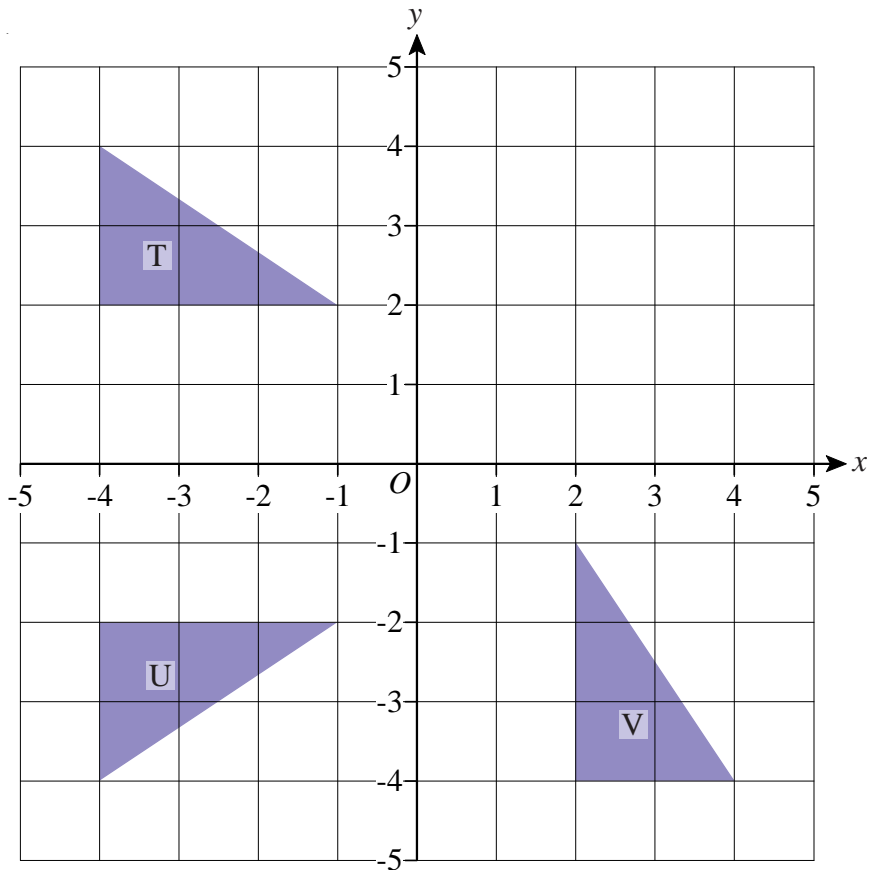

# Rotations

- 1) a) Rotate triangle T  $90^\circ$  anti-clockwise about the point (0, 0).  
Label your new triangle U.
- b) Rotate triangle T  $180^\circ$  about the point (2, 0).  
Label your new triangle V.

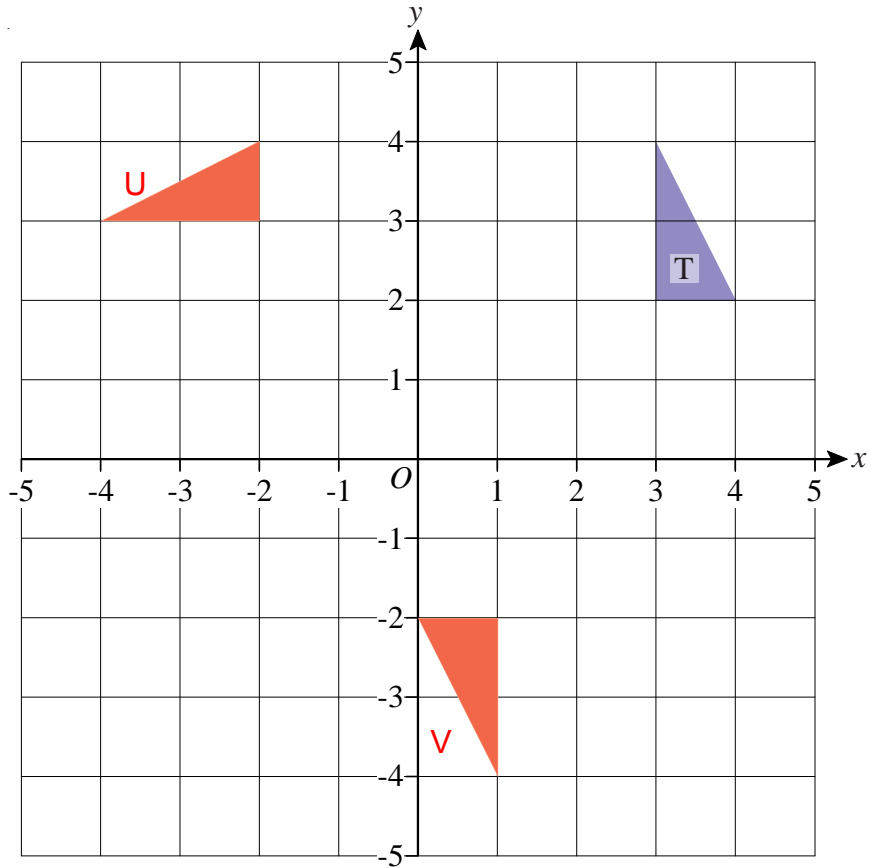

- 2) Describe fully the single transformation which maps triangle T to triangle U.

**Rotation**  
 **$90^\circ$  clockwise**  
**about the point (-1, -1)**

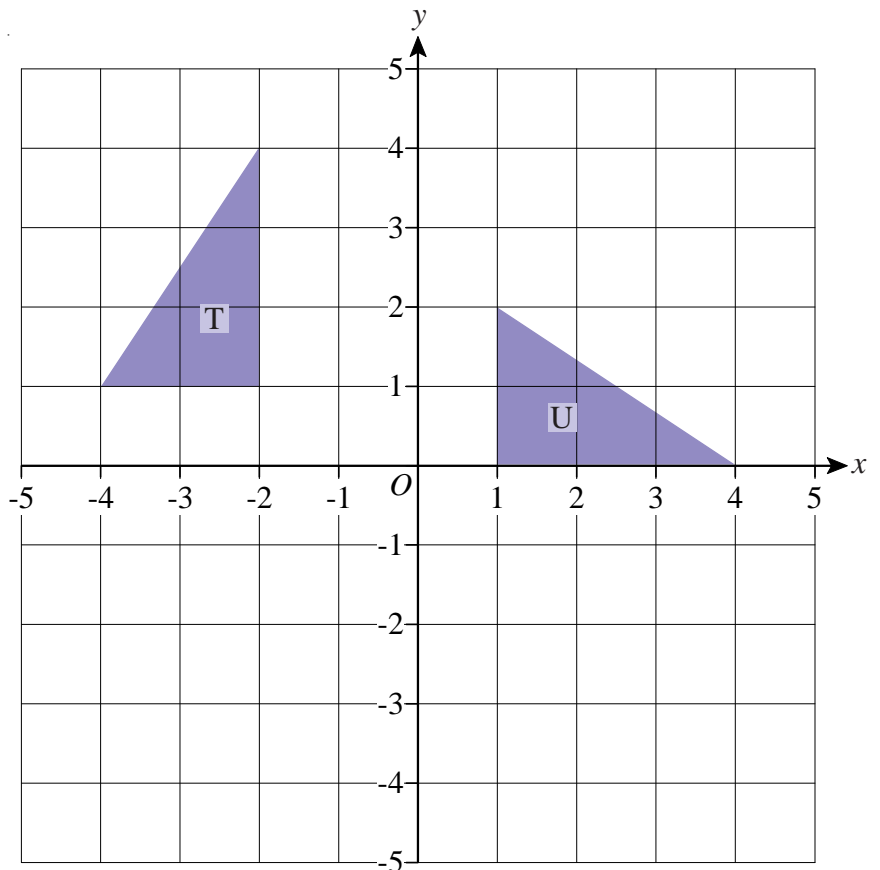

# Translations

1) a) Translate triangle T by vector  $\begin{bmatrix} -4 \\ 2 \end{bmatrix}$  and label it U.

b) Translate triangle T by vector  $\begin{bmatrix} 3 \\ -2 \end{bmatrix}$  and label it V.

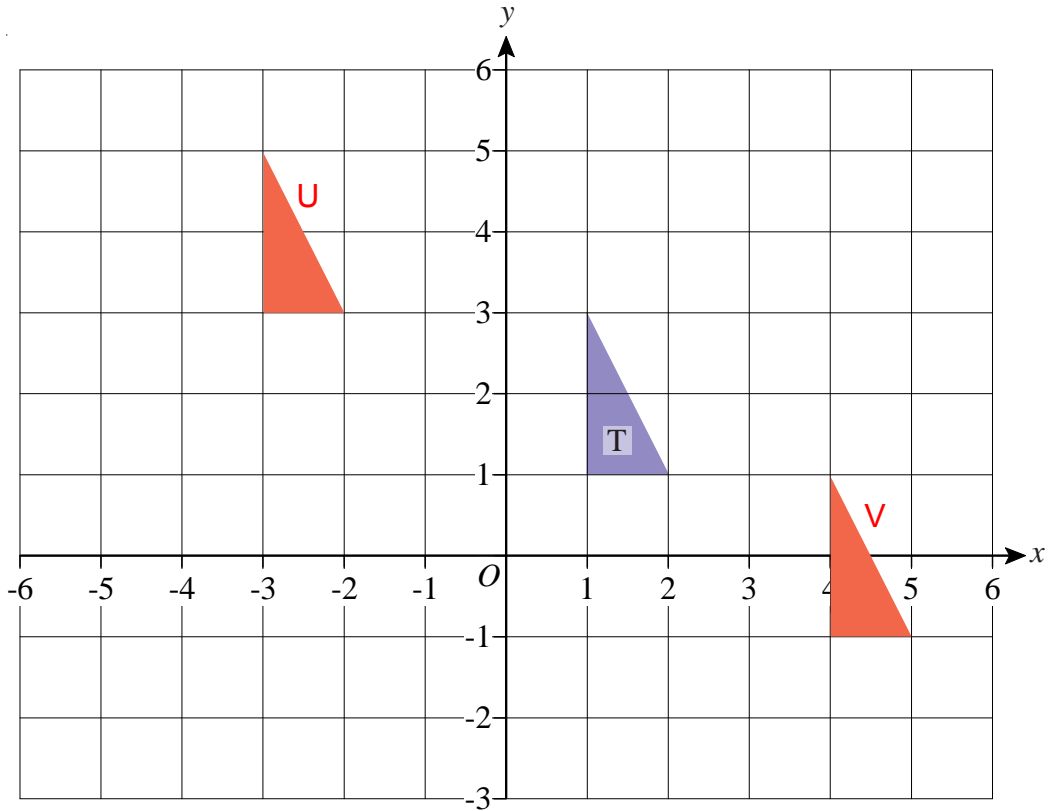

2) a) Describe fully the single transformation which maps triangle A to triangle B.  
Translate triangle A by vector  $\begin{bmatrix} -6 \\ -3 \end{bmatrix}$

b) Describe fully the single transformation which maps triangle A to triangle C.  
Translate triangle A by vector  $\begin{bmatrix} 3 \\ -7 \end{bmatrix}$

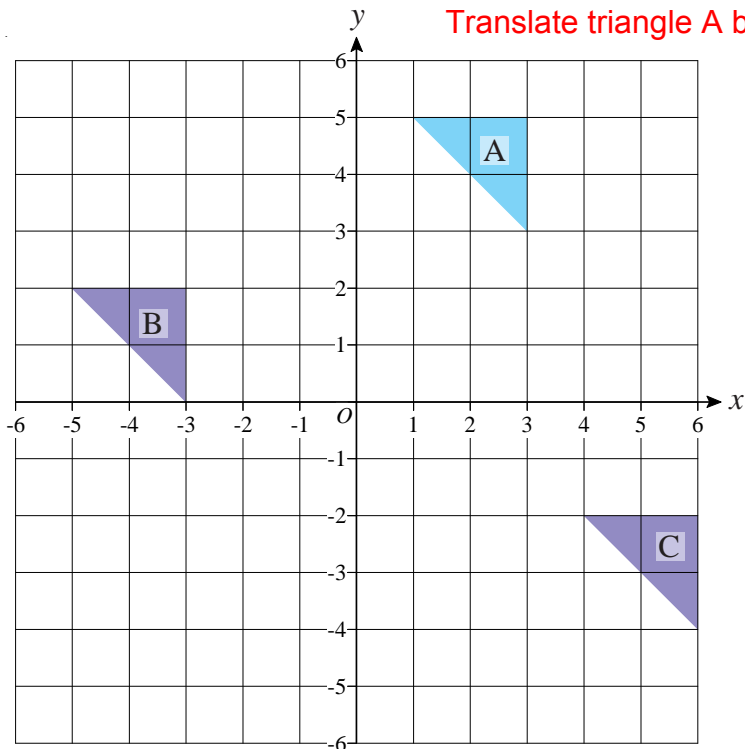

- 1) The diagram shows a prism drawn on an isometric grid.

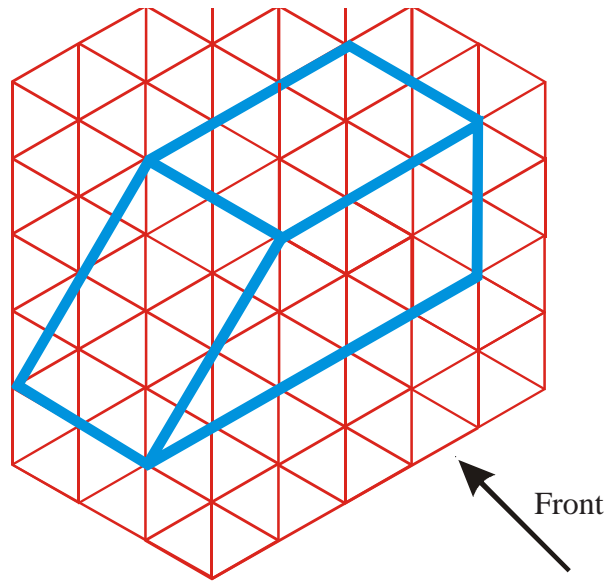

- a) On the grid below, draw the front elevation of the prism from the direction marked by the arrow.

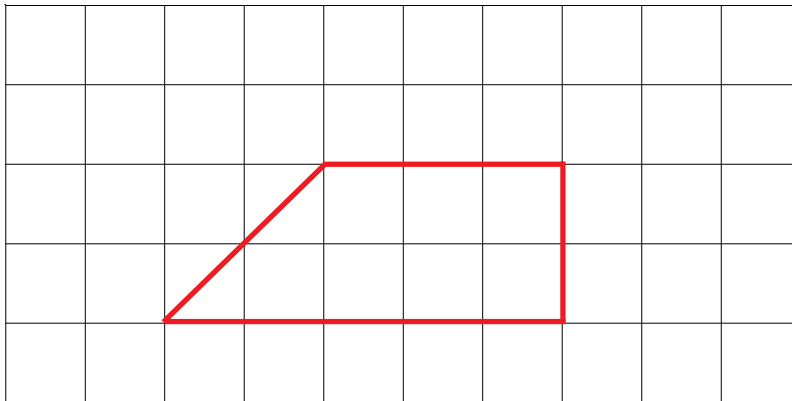

- b) On the grid below draw a plan of the prism.

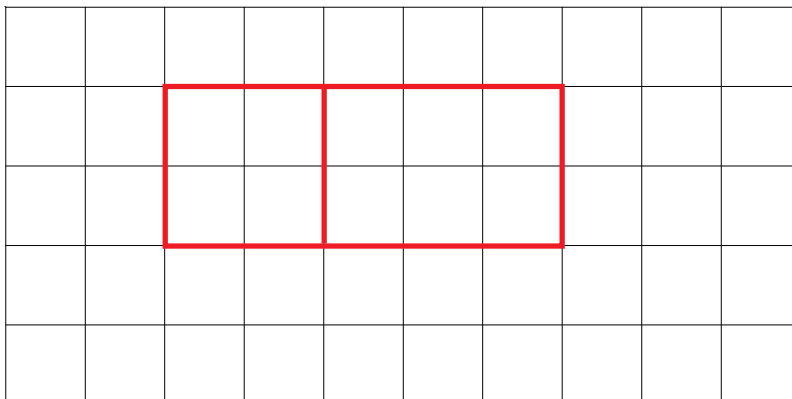



- 1) Here is the plan and front elevation of a prism.  
The front elevation shows the cross section of the prism.

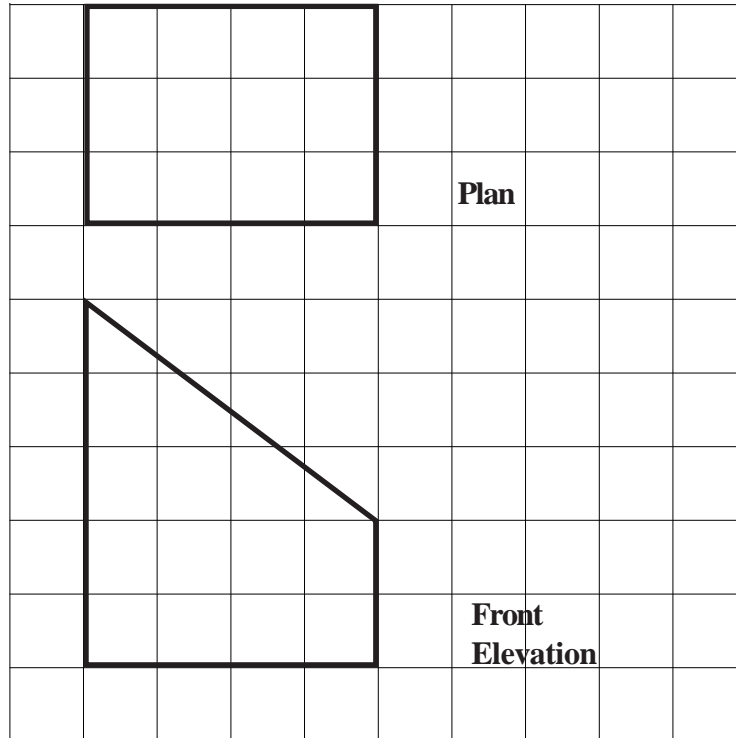

On the grid below, draw the side elevation of the prism.

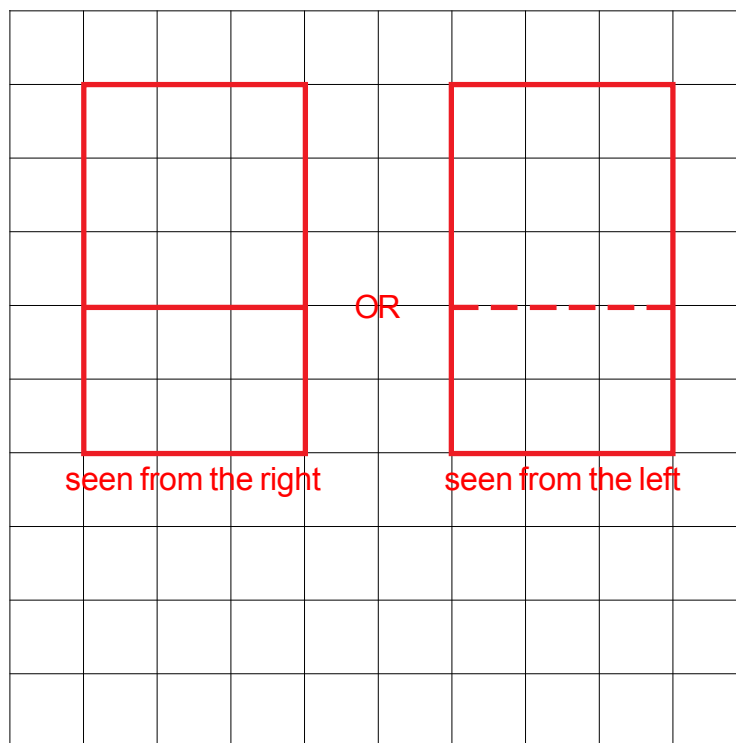

- 1) The diagram shows a solid prism made from centimetre cubes.

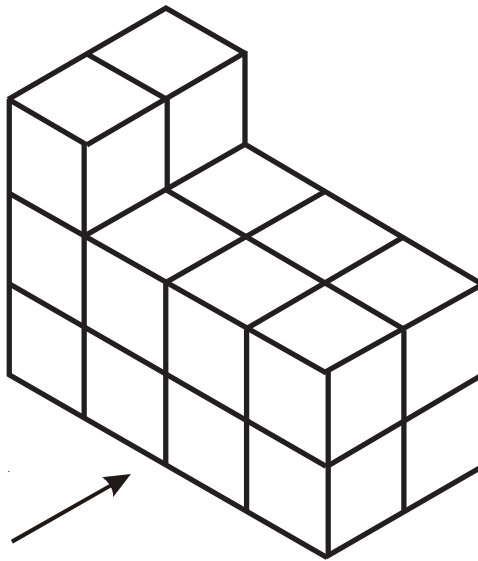

- a) On the centimetre square grid, draw the front elevation of the solid prism from the direction shown by the arrow.

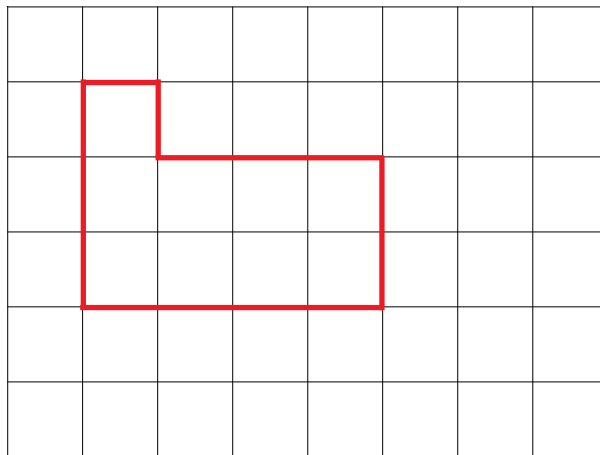

- b) On the centimetre square grid below, draw the plan of the solid prism.

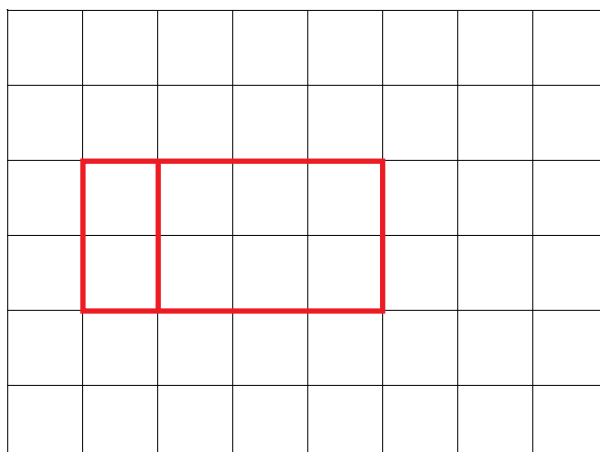

- 1) The diagram shows a solid prism.

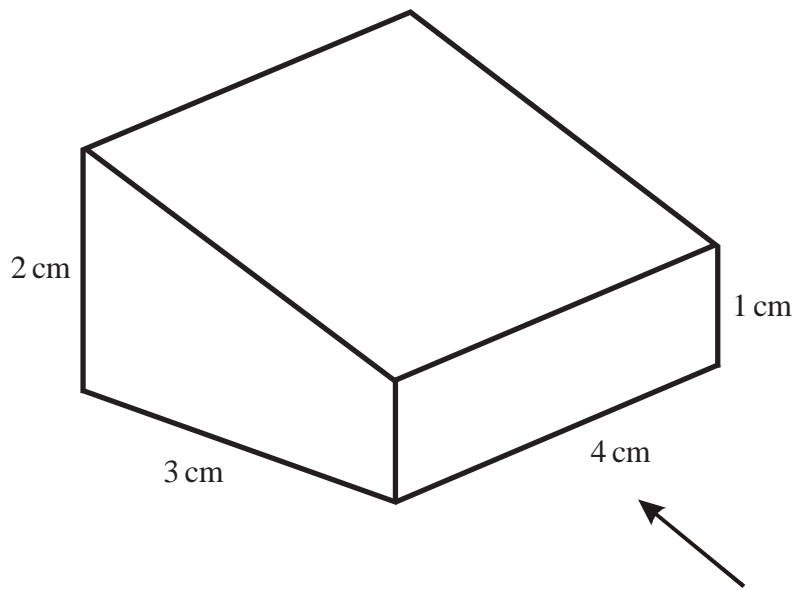

- a) On the grid below, draw the front elevation of the prism from the direction of the arrow.

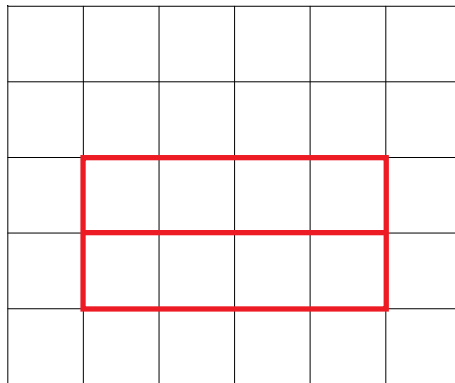

- b) On the grid below, draw the plan of the prism.

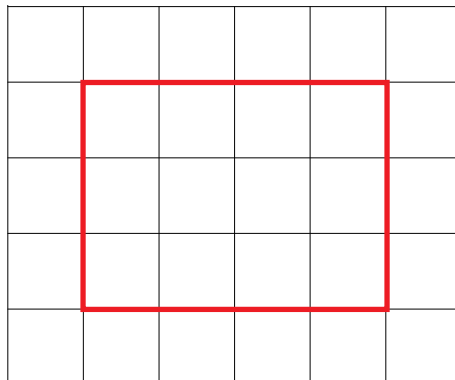

# Perimeters

1) Find the perimeters of the following two shapes.

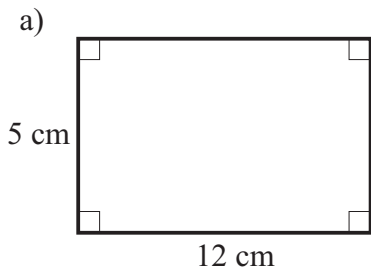

**34 cm**

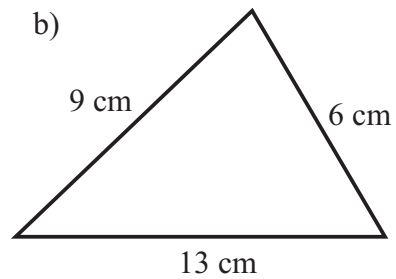

**28 cm**

2) The length of a rectangle is 9 cm.  
The total perimeter is 30 cm.

Calculate the length of the width of the rectangle. **6 cm**

3) Work out the perimeter of this L shape. **68 cm**

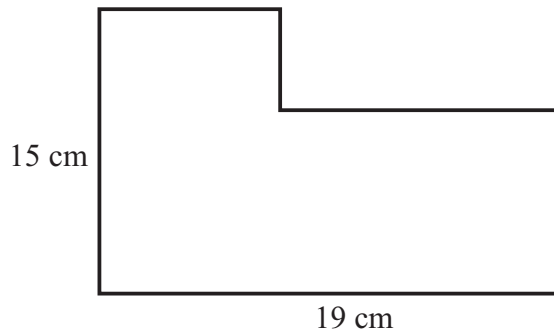

4) This shape is made by cutting out an equilateral triangle from a square.

Two of these shapes are then put together to make this shape.

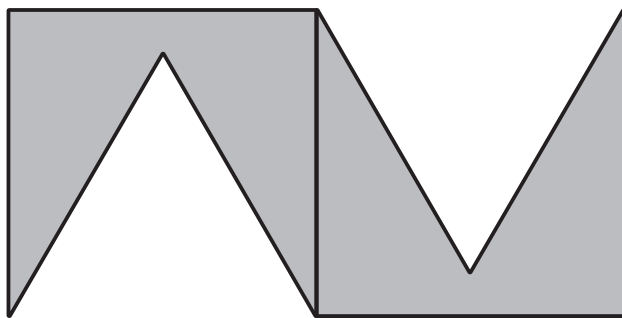
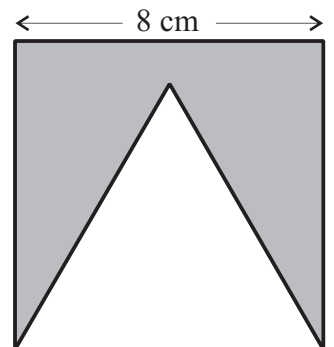

Work out the perimeter of this new shape. **64 cm**

## Area of a Rectangle

1) Find the areas of these two rectangles.

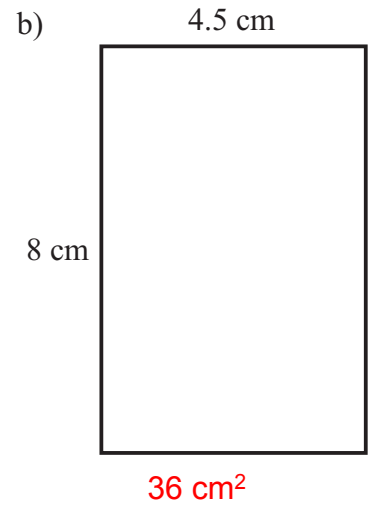
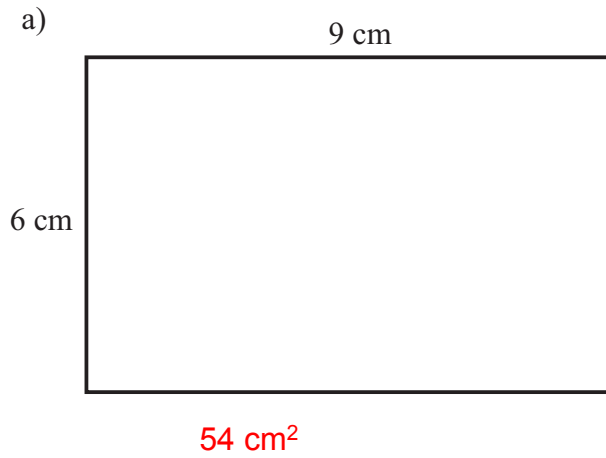

2) Find the size of the missing sides in these two rectangles.

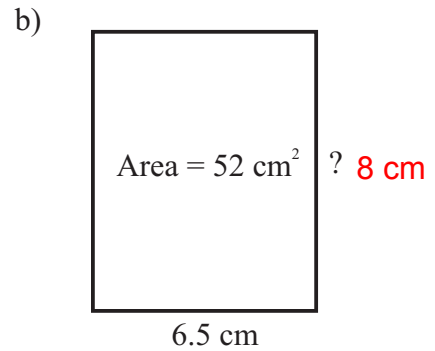
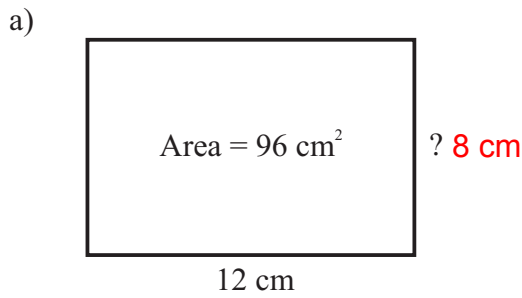

3) Find the area of the shaded section.

$123 \text{ cm}^2$

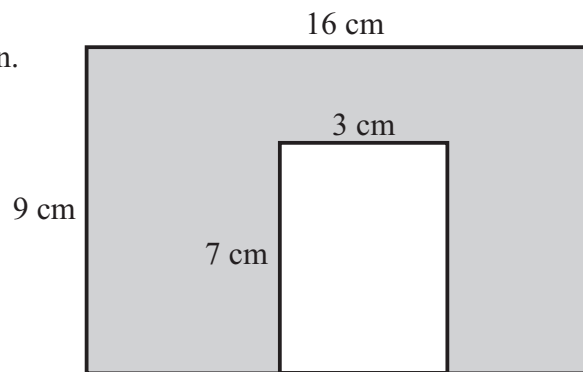

4) Find the area of the L shape.

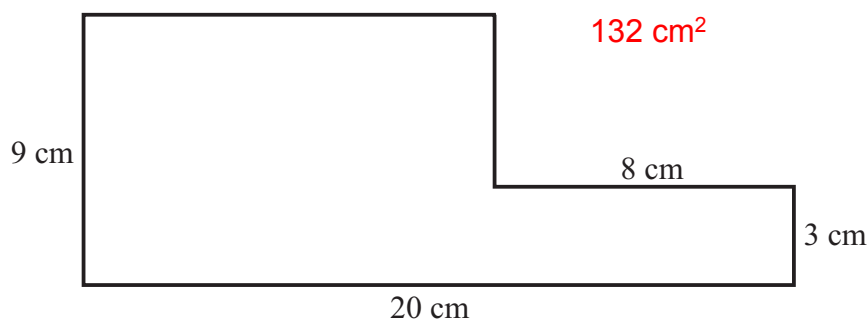

## Area of a Triangle

1) Find the areas of the following two triangles.

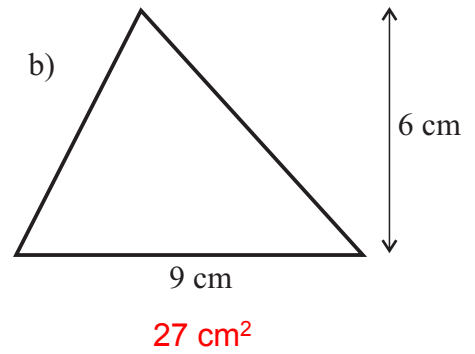
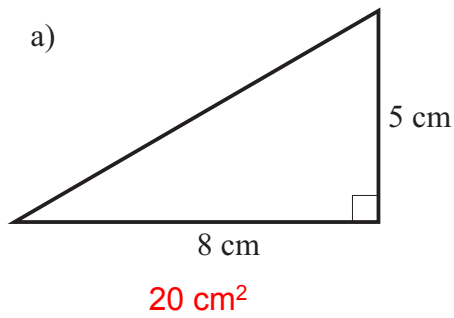

2) Find the missing lengths.

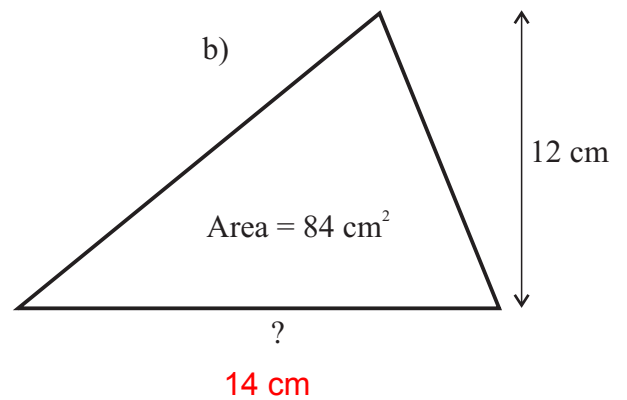
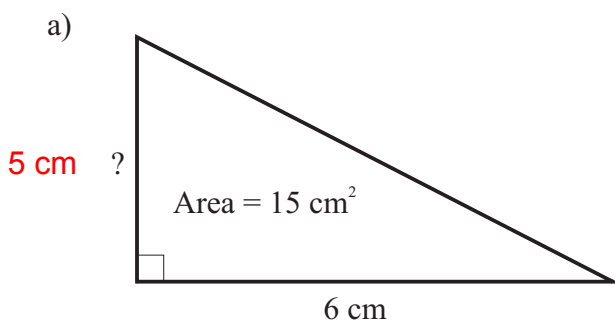

3)  $ABCD$  is a square.

$PQRS$  is a square.

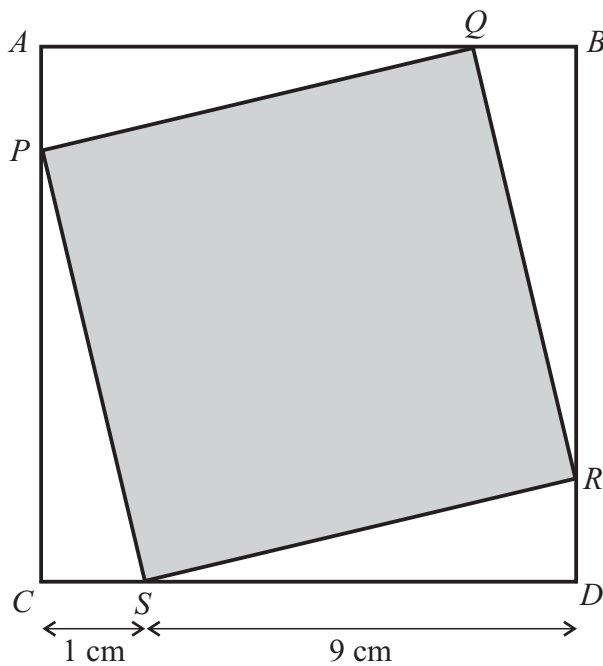

Find the area of the shaded square,  $PQRS$ .  $82 \text{ cm}^2$

## Area of a Parallelogram

1) Find the area of each of these parallelograms.

a)

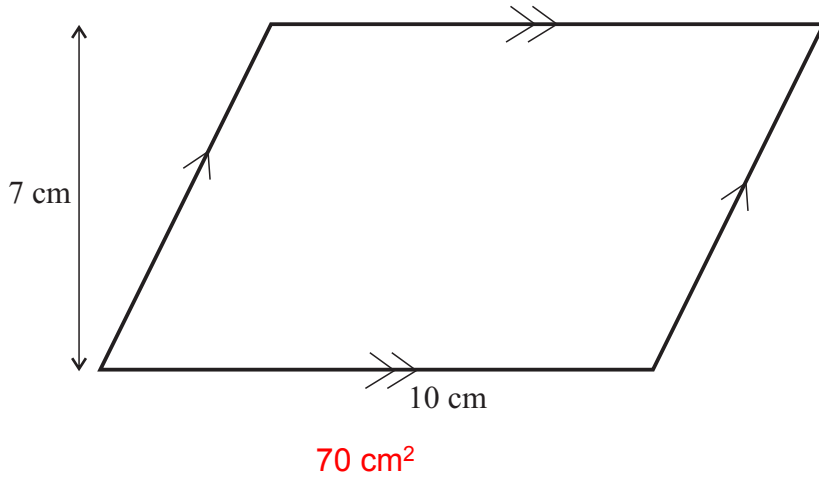

b)

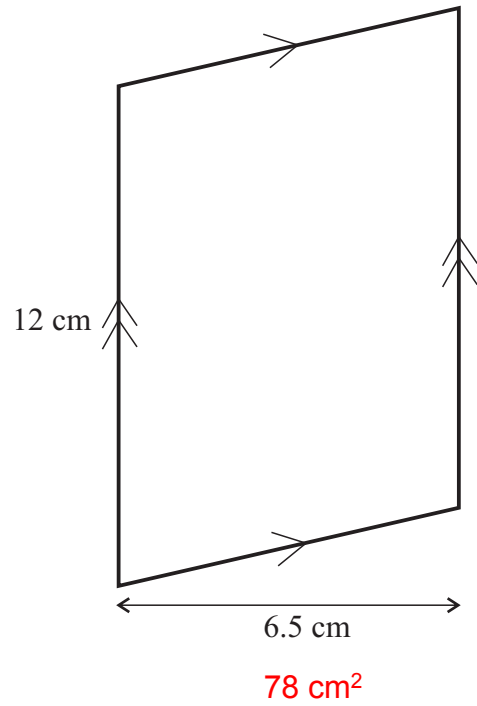

2) Find the missing lengths in these two parallelograms.

a)

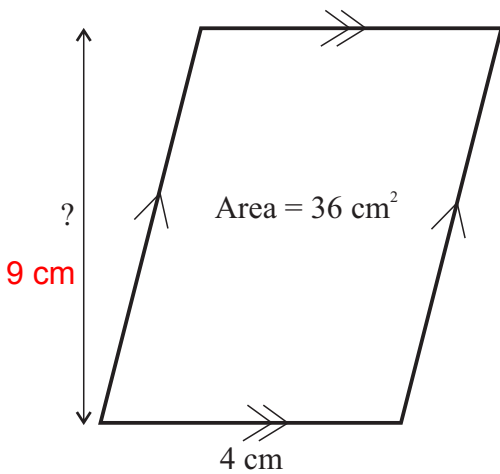

b)

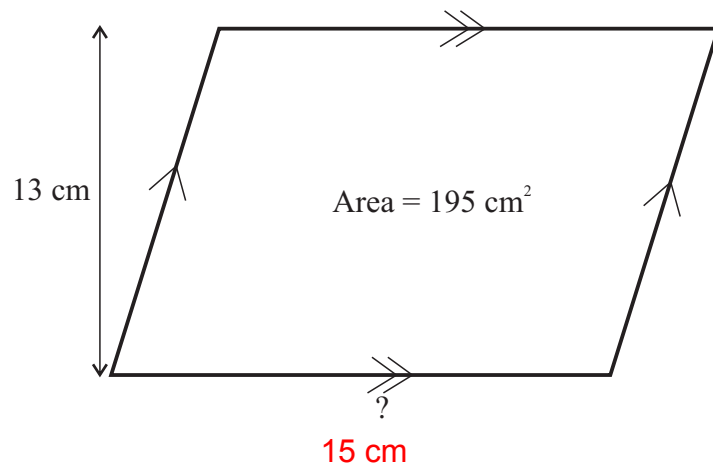

1) Find the area of this trapezium.

**36 cm<sup>2</sup>**

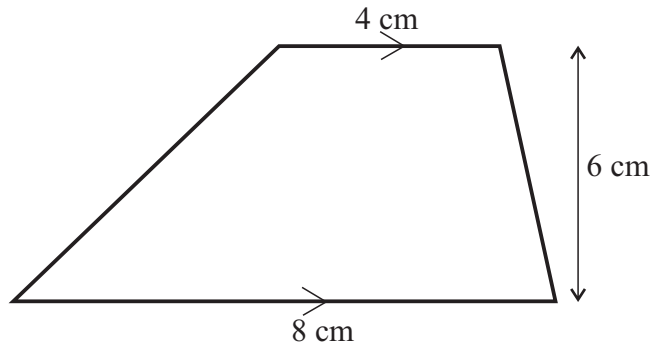

2) The diagram shows a field.

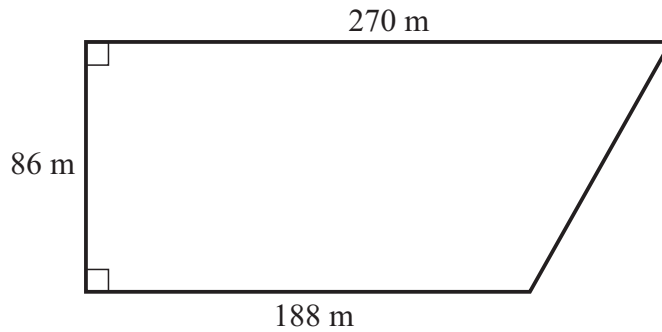

Work out the area of the field. **19694 m<sup>2</sup>**



3) In the trapezium,  $a = 6.6$  cm,  $b = 8.4$  cm and  $h = 3.6$  cm.

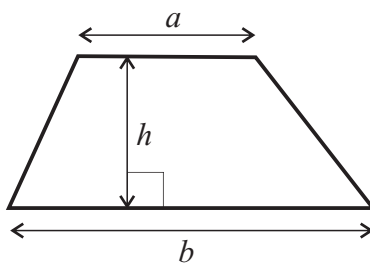

Work out the area of the trapezium. **27 cm<sup>2</sup>**



4) In the trapezium below, the area is 45 cm<sup>2</sup>.  
 $a = 5$  cm and  $b = 10$  cm.

Calculate the height,  $h$ , of the trapezium. **6 cm**

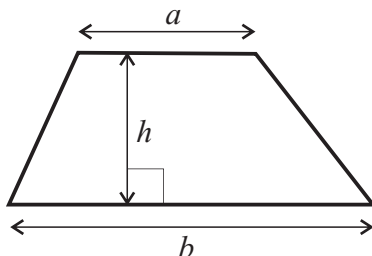



## Frequency Trees

100 people underwent an operation at a hospital.

Before the operation, based on their medical notes, it was predicted whether each person would make a full recovery or not.

It was predicted that 85 people would make a full recovery.

It was later found that 6 of the people expected to fully recover, didn't.

Altogether, 87 people made a full recovery.

Complete the frequency tree.

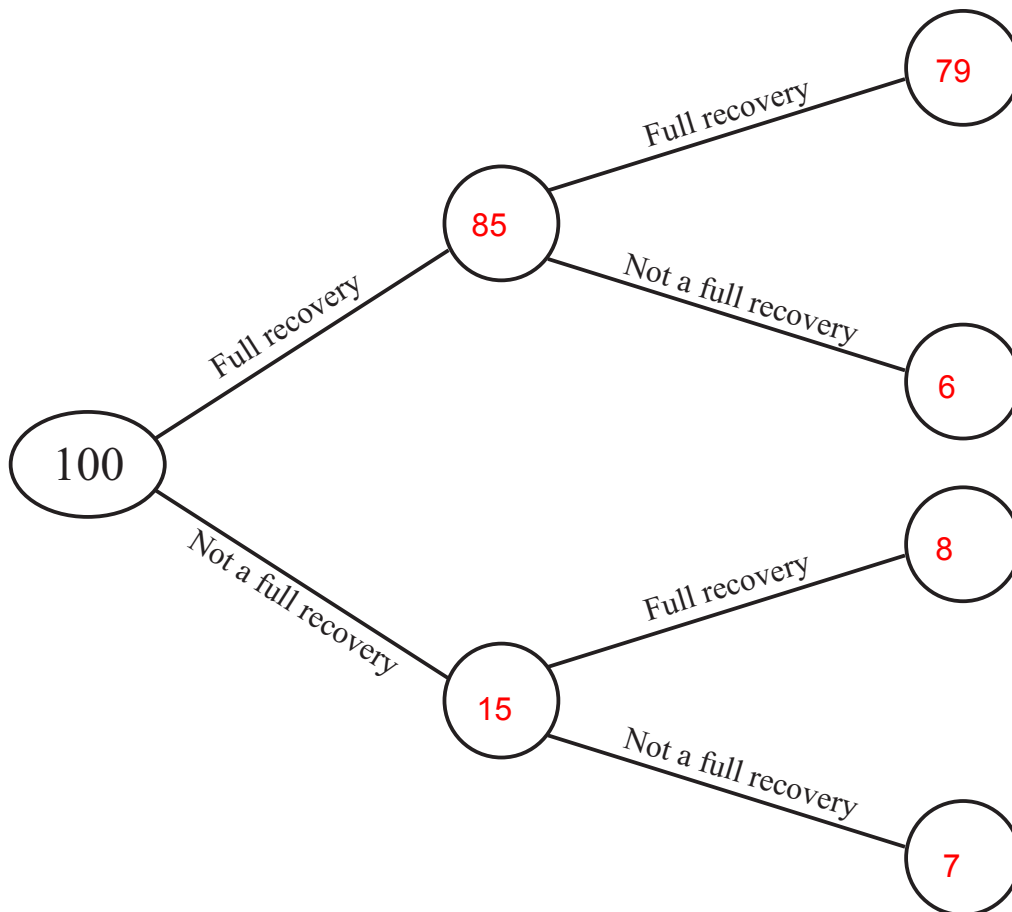

- 1) List all the outcomes if two coins are flipped.

HH, HT, TH, TT

- 2) a) How many possible outcomes are there if three coins are flipped? 8

- b) List them all - the first one has been done for you: H H H

HHT, HTH, THH, TTH, THT, HTT, TTT

- 3) a) How many possible outcomes are there if two six-sided dice are rolled? 36

- b) List them all.

1 1, 1 2, 1 3, 1 4, 1 5, 1 6	4 1, 4 2, 4 3, 4 4, 4 5, 4 6
2 1, 2 2, 2 3, 2 4, 2 5, 2 6	5 1, 5 2, 5 3, 5 4, 5 5, 5 6
3 1, 3 2, 3 3, 3 4, 3 5, 3 6	6 1, 6 2, 6 3, 6 4, 6 5, 6 6

- 4) a) How many possible outcomes are there if a coin is flipped and a dice is rolled? 12

- b) List them all.

H 1, H 2, H 3, H 4, H 5, H 6  
T 1, T 2, T 3, T 4, T 5, T 6

- 5) a) How many possible outcomes are there if two coins are flipped and a dice is rolled? 24

- b) List them all.

HH 1, HH 2, HH 3, HH 4, HH 5, HH 6  
HT 1, HT 2, HT 3, HT 4, HT 5, HT 6  
TH 1, TH 2, TH 3, TH 4, TH 5, TH 6  
TT 1, TT 2, TT 3, TT 4, TT 5, TT 6

- 6) How many possible outcomes are there if 6 coins are flipped? 64



- 7) If Carly has each fingernail painted at a salon and can choose between red, blue and green for each nail, how many different combinations are there for her to choose from? 59049

- 1) A box contains 3 grey counters and 2 white counters.  
A counter is taken from the box at random.  
What is the probability of choosing a white counter?

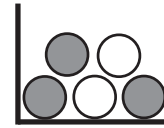

$$\frac{2}{5}$$

- 2) There are 3 blue counters, 5 red counters and 7 green counters in a bag.

A counter is taken from the bag at random.

- a) What is the probability that a green counter will be chosen?  $\frac{7}{15}$   
b) What is the probability that a blue or red counter will be chosen?  $\frac{8}{15}$

- 3) In a class there are 10 boys and 15 girls.

A teacher chooses a student at random from the class.

Eric says that the probability a boy will be chosen is 0.5 because a student can be either a boy or a girl.

Jenny says that Eric is wrong.

Decide who is correct - Eric or Jenny - giving reasons for your answer.

**Jenny is correct because there are more girls than boys, so the probability of choosing a girl will be greater than that of choosing a boy.**

- 4) Spinner A has numbers 1 to 4 on it.

Spinner B has numbers 1 to 3 on it.

Both spinners are spun and the numbers on each are added together to give a score.

What is the probability that the score will be

- a) 7?  $\frac{1}{12}$   
b) 3 or 4?  $\frac{5}{12}$

## Mutually Exclusive Events

- 1) If the probability of passing a driving test is 0.54,  
what is the probability of failing it? **0.46**
- 2) The probability that a football team will win their next game is  $\frac{2}{11}$ .  
The probability they will lose is  $\frac{3}{11}$ .  
What is the probability the game will be a draw?  **$\frac{6}{11}$**



- 3) On the school dinner menu there is only ever one of four options.  
Some of the options are more likely to be on the menu than others.  
The table shows the options available on any day, together with three of the probabilities.

Food	Curry	Sausages	Fish	Casserole
Probability	0.36	0.41	<b>0.14</b>	0.09

- a) Work out the probability of the dinner option being Fish. **0.14**
- b) Which option is most likely? **Sausages**
- c) Work out the probability that it is a Curry or Sausages on any particular day. **0.77**
- d) Work out the probability that it is **not** Casserole. **0.91**



- 4) Julie buys a book every week.  
Her favourite types are Novel, Drama, Biography and Romance.  
The table shows the probability that Julie chooses a particular type of book.

Type of book	Novel	Drama	Biography	Romance
Probability	0.24	0.16	$x$	$x$

- a) Work out the probability that she will choose a Novel or a Drama. **0.4**
- b) Work out the probability that she will choose a Biography or a Romance. **0.6**

The probability that she will choose a Biography is the same as the probability she will choose a Romance.

- c) Work out the probability that she will choose a Biography. **0.3**

## Two-Way Tables

- 1) Billy has been carrying out a survey.  
He asked 100 people the type of water they like to drink (still, sparkling or both).  
Here are part of his results:

	Still	Sparkling	Both	Total
Male	26	21	6	53
Female	17	20	10	47
Total	43	41	16	100

- a) Complete the two-way table.
- b) How many males were in the survey? **53**
- c) How many females drink only still water? **17**
- d) How many people drink only sparkling water? **41**
- 2) 90 students each study one of three languages.  
The two-way table shows some information about these students.

	French	German	Spanish	Total
Female	6	11	23	40
Male	14	7	29	50
Total	20	18	52	90

- 50 of the 90 students are male.  
29 of the 50 male students study Spanish.
- a) Complete the two-way table.
- b) How many females study French? **6**
- c) How many people study Spanish? **52**
- 3) Karen asks 100 students if they like milk, plain or white chocolates best.  
36 of the students are girls.  
19 of these girls like milk chocolates best.  
16 boys like white chocolates best.  
8 out of the 24 students who like plain chocolates best are girls.  
Work out the number of students who like milk chocolates the best. **51**



- 1) Kaya made a list of his homework marks.

3 2 3 4 1 4 5 4

- a) Write down the mode of Kaya's marks. **4**  
b) Work out his mean homework mark. **3.25**

- 2) Lydia rolled an 8-sided dice ten times.  
Here are her scores.

5 1 2 5 3 8 6 6 3 2

- a) Work out Lydia's median score. **4**  
b) Work out the mean of her scores. **4.1**



- 3) In a two-week period, a train was this many minutes late each day:

3 0 0 0 7 4 5 2 0 1 14 0 5 1

- a) What was the mean average number of minutes late? **3 minutes late**  
b) What was the median average number of minutes late? **1.5 minutes late**



- 4) Two small Year 10 classes, Set A and Set B, sat the same Science test.

Set A had these scores for the test:

63%, 71%, 48%, 95%, 46%, 82%, 77%, 36%, 73%

Set B had these scores:

58%, 63%, 85%, 61%, 59% 38%, 90%, 84%, 75%, 48%

How much bigger was Set B's mean average score than Set A's mean average score?  
Give your answer correct to 1 decimal place. **0.4%**



- 5) A rugby team played six games.

The mean score for the six games is 15

The rugby team played one more game.

The mean score for all seven games is 16

Work out the number of points the team scored in the seventh game. **22**

- 1) Out of the following types of data, decide which is continuous and which is discrete:

The lengths of some roads. **Continuous**

The number of 'cats eyes' on a one mile stretch of road. **Discrete**

The time it takes twenty students to complete an English essay. **Continuous**

The number of pages in twenty students English essays. **Discrete**

The weights of sacks of potatoes. **Continuous**

The number of potatoes in some sacks of potatoes. **Discrete**

The depth of water as the tide comes in and goes out. **Continuous**

The number of crackers in some packets of biscuits. **Discrete**

The weight of the crackers in some packs of biscuits. **Continuous**

- 2) Write a short statement which explains what continuous data is.  
**Continuous data is data that is measured using a continuous scale.**
- 3) Write a short statement which explains what discrete data is.  
**Discrete data is data that is counted.**

1) The line chart shows the test scores of pupils in class 10A.

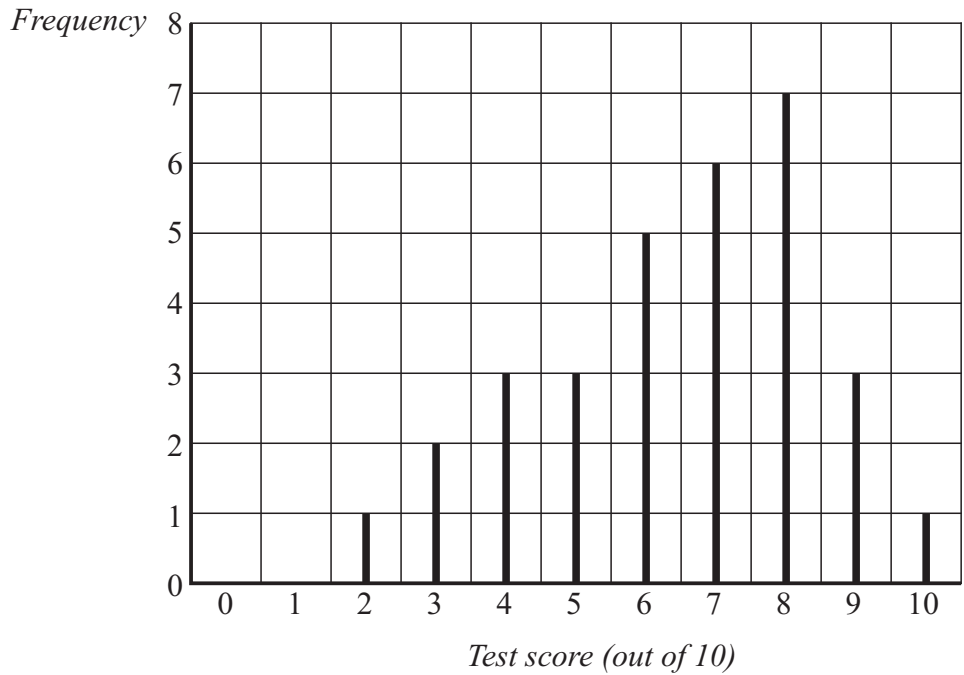

- a) How many pupils sat the test in class 10A? **31**
- b) What was the modal test score? **8**
- c) What was the median test score? **7**

2) The line chart shows the number of goals scored by a football team in their last 16 games.

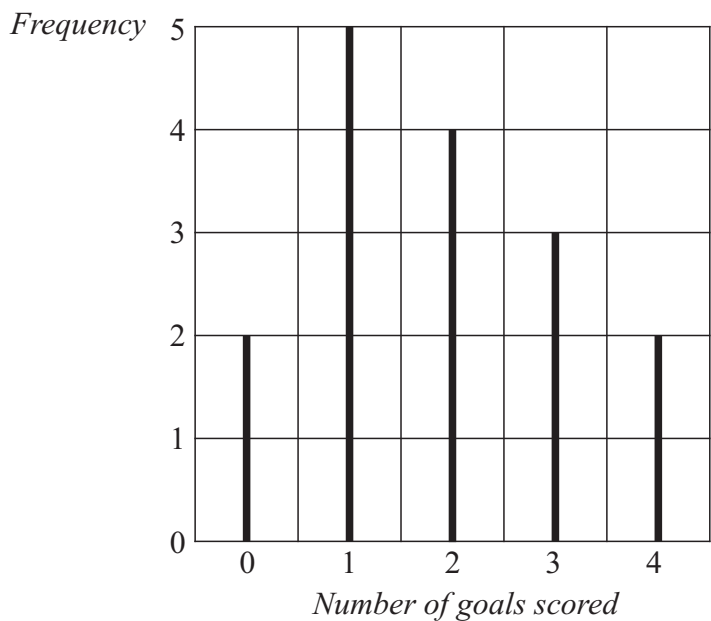

- a) How many goals did they score altogether? **30**
- b) What was the median number of goals scored? **2**



# Frequency Tables and Diagrams

- 1) A class of pupils is asked to solve a puzzle.  
The frequency table below shows the times taken by the pupils to solve the puzzle.

Time ( $t$ ) in min	Frequency
$0 < t \leq 5$	3
$5 < t \leq 10$	4
$10 < t \leq 15$	5
$15 < t \leq 20$	7
$20 < t \leq 25$	5

Draw a frequency diagram to show this information.

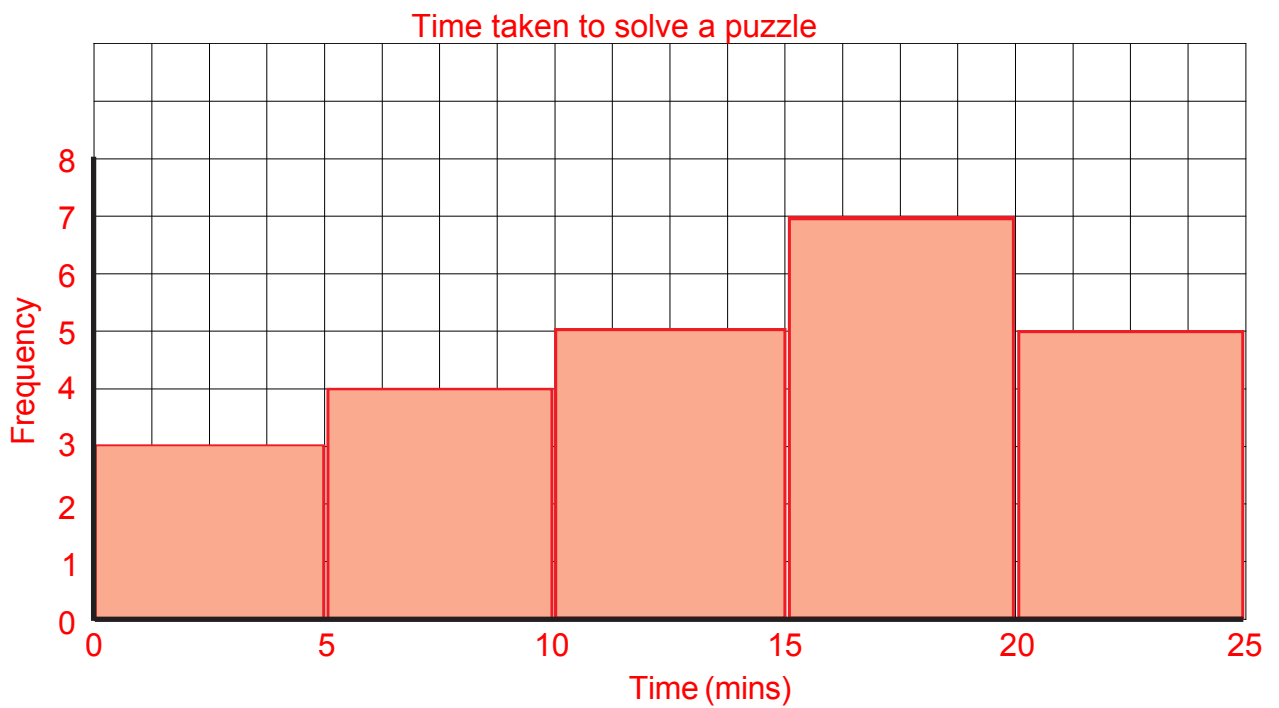

1) Work out

a)  $6 \times 0.2$  **1.2**

b)  $0.2 \times 0.3$  **0.06**

c)  $0.4 \times 7$  **2.8**

d)  $0.2 \times 0.8$  **0.16**

e)  $0.03 \times 0.9$  **0.027**

f)  $1.5 \times 0.2$  **0.3**

2) A box contains 7 books, each weighing 2.5 kg.

Work out the total weight of the box. **17.5 kg**

3) Jim takes 13 boxes out of his van.

The weight of each box is 25.5 kg.

Work out the total weight of the 13 boxes. **331.5 kg**

4) Tim has a job which pays £6.85 per hour.

If he works for 34 hours, one week, how much does he earn? **£232.90**

5) Sue has a part-time job and the hourly pay is £7.50 per hour.

How much does she earn if she works for 8.5 hours, one week? **£63.75**

6) Fencing costs £13.25 per metre.

How much does 12.5 m cost? **£165.63**

1) Work out

a)  $9 \div 0.3$     **30**

b)  $6 \div 0.1$     **60**

c)  $12 \div 0.4$     **30**

d)  $25 \div 0.5$     **50**

e)  $21 \div 0.3$     **70**

f)  $15 \div 0.2$     **75**

2) Work out

a)  $3.6 \div 0.4$     **9**

b)  $0.8 \div 0.2$     **4**

c)  $2.4 \div 0.4$     **6**

d)  $0.56 \div 0.08$     **7**

e)  $5.5 \div 0.05$     **110**

f)  $8.1 \div 0.09$     **90**

3) John takes boxes out of his van.

The total weight of the boxes is 4.9 kg

The weight of each box is 0.7 kg

Work out the number of boxes in John's van.    **7**

4) Mr Rogers bought a bag of elastic bands for £6

Each elastic band costs 12p.

Work out the number of elastic bands in the bag.    **50**

1) Work out the following:

a)  $2 - 7$  **-5**

b)  $4 - 6$  **-2**

c)  $1 - 8$  **-7**

d)  $0 - 4$  **-4**

2) Work out the following:

a)  $-3 + 2$  **1**

b)  $-7 + 5$  **-2**

c)  $-3 + 8$  **5**

d)  $-9 + 11$  **2**

3) Work out the following:

a)  $-1 - 3$  **-4**

b)  $-4 - 5$  **-9**

c)  $-7 - 8$  **-15**

d)  $-2 - 12$  **-14**

4) Work out the following:

a)  $6 - -3$  **9**

b)  $-3 - -5$  **2**

c)  $-9 - -2$  **-7**

d)  $1 - -13$  **14**

5) Work out the following:

a)  $-3 \times 4$  **-12**

b)  $5 \times -2$  **-10**

c)  $-4 \times -5$  **20**

d)  $-6 \times -3$  **18**

6) Work out the following:

a)  $12 \div -4$  **-3**

b)  $-20 \div -2$  **10**

c)  $-15 \div 3$  **-5**

d)  $-100 \div -5$  **20**

## Listing Strategies

- 1) A restaurant has the simple menu, as shown.

Meg chooses a starter, a main course and a dessert.

List all the possible combinations that Meg could choose.

Soup, Chicken, Ice Cream      Soup, Vegetarian, Ice Cream  
 Soup, Chicken, Trifle          Soup, Vegetarian, Trifle  
 Melon, Chicken, Ice Cream      Melon, Vegetarian, Ice Cream  
 Melon, Chicken, Trifle          Melon, Vegetarian, Trifle  
 Soup, Steak, Ice Cream  
 Soup, Steak, Trifle  
 Melon, Steak, Ice Cream  
 Melon, Steak, Trifle

<u>Starter</u>
Soup
Melon
<u>Main Course</u>
Chicken
Steak
Vegetarian
<u>Dessert</u>
Ice Cream
Trifle

- 2) 

4
---

7
---

1
---

- a) Make a list of all the two-digit numbers that can be made with these three cards.  
 47, 41, 71, 74, 14, 17  
 b) Make a list of all the three-digit numbers that can be made with these three cards.  
 471, 417, 741, 714, 147, 174

- 3) Phil has three different coins.

He has: a £2 coin

a £1 coin

a 50p coin

- a) If he chooses exactly two coins, what amounts of money can he make?  
 £3 or £2.50 or £1.50  
 b) If he chooses one or two coins, what amounts of money can he make?  
 £2 or £1 or 50p or £3 or £2.50 or £1.50  
 c) If he chooses one, two or three coins, what amounts of money can he make?  
 £2 or £1 or 50p or £3 or £2.50 or £1.50 or £3.50

- 1) Put these fractions in order of size, smallest to largest.  
Show your working for each question.

a)  $\frac{1}{2}$     $\frac{1}{3}$     $\frac{1}{3}$     $\frac{2}{6}$

b)  $\frac{3}{5}$     $\frac{2}{3}$     $\frac{3}{5}$     $\frac{2}{3}$

c)  $\frac{1}{2}$     $\frac{3}{8}$     $\frac{3}{8}$     $\frac{4}{8}$

- 2) Put these fractions in order of size, smallest to largest.  
Show your working for each question.

a)  $\frac{1}{2}$     $\frac{1}{4}$     $\frac{3}{8}$     $\frac{1}{4}$     $\frac{3}{8}$     $\frac{1}{2}$

b)  $\frac{3}{5}$     $\frac{1}{2}$     $\frac{3}{4}$     $\frac{1}{2}$     $\frac{3}{5}$     $\frac{3}{4}$

c)  $\frac{5}{6}$     $\frac{2}{3}$     $\frac{3}{4}$     $\frac{2}{3}$     $\frac{3}{4}$     $\frac{5}{6}$

- 3) Put these fractions in order of size, smallest to largest.  
Show your working for each question.

a)  $\frac{2}{3}$     $\frac{7}{12}$     $\frac{3}{4}$     $\frac{5}{6}$     $\frac{7}{12}$     $\frac{2}{3}$     $\frac{3}{4}$     $\frac{5}{6}$

b)  $\frac{5}{8}$     $\frac{2}{3}$     $\frac{3}{24}$     $\frac{7}{12}$     $\frac{3}{24}$     $\frac{7}{12}$     $\frac{5}{8}$     $\frac{2}{3}$

c)  $\frac{6}{10}$     $\frac{4}{5}$     $\frac{5}{12}$     $\frac{8}{15}$     $\frac{5}{12}$     $\frac{8}{15}$     $\frac{6}{10}$     $\frac{4}{5}$

- 4) Ben spent his pocket money this way:

$\frac{7}{20}$  on magazines

$\frac{4}{10}$  on chocolates

$\frac{1}{4}$  on games

Order the items Ben bought by value, largest first. **Chocolates, magazines, games**  
Show all your working.

## Adding and Subtracting Fractions

In all the questions on this page, please give your answers in their simplest form.

1) Work out the following:

a)  $\frac{1}{7} + \frac{3}{7} = \frac{4}{7}$

b)  $\frac{4}{9} + \frac{1}{9} = \frac{5}{9}$

2) Work out the following:

a)  $\frac{1}{5} + \frac{3}{4} = \frac{19}{20}$

b)  $\frac{3}{8} + \frac{1}{4} = \frac{5}{8}$

c)  $\frac{2}{3} + \frac{3}{10} = \frac{29}{30}$

d)  $\frac{1}{2} + \frac{2}{5} = \frac{9}{10}$

3) Work out the following:

a)  $\frac{2}{3} + \frac{1}{2} = 1\frac{1}{6}$

b)  $\frac{3}{5} + \frac{2}{3} = 1\frac{4}{15}$

c)  $\frac{5}{8} + \frac{3}{4} = 1\frac{3}{8}$

d)  $\frac{5}{7} + \frac{2}{5} = 1\frac{4}{35}$

4) Work out the following:

a)  $2\frac{1}{2} + 1\frac{3}{4} = 4\frac{1}{4}$

b)  $1\frac{2}{5} + \frac{2}{3} = 2\frac{1}{15}$

c)  $2\frac{1}{6} + 1\frac{1}{2} = 3\frac{2}{3}$

d)  $1\frac{3}{7} + \frac{2}{5} = 1\frac{29}{35}$

5) Work out the following:

a)  $\frac{3}{4} - \frac{1}{2} = \frac{1}{4}$

b)  $\frac{5}{7} - \frac{2}{3} = \frac{1}{21}$

c)  $\frac{5}{8} - \frac{1}{3} = \frac{7}{24}$

d)  $\frac{8}{9} - \frac{2}{3} = \frac{2}{9}$

6) Work out the following:

a)  $2\frac{1}{2} - 1\frac{3}{4} = \frac{3}{4}$

b)  $1\frac{2}{3} - \frac{3}{4} = \frac{11}{12}$

c)  $3\frac{2}{5} - 1\frac{1}{2} = 1\frac{9}{10}$

d)  $2\frac{3}{8} - \frac{3}{5} = 1\frac{31}{40}$

7) Ted received his pocket money on Friday.

He spent  $\frac{3}{5}$  of his pocket money on games.

He spent  $\frac{1}{10}$  of his pocket money on magazines.

What fraction of his pocket money did he have left?  $\frac{3}{10}$

8) Maisie buys a bag of flour.

She uses  $\frac{1}{4}$  to bake a cake and  $\frac{2}{5}$  to make a loaf.

a) What fraction of the bag of flour was used?  $\frac{13}{20}$

b) What fraction of the bag of flour is left?  $\frac{7}{20}$

9) Work out the total length of this shape.  
Give your answer as a mixed number.

$5\frac{11}{12}$

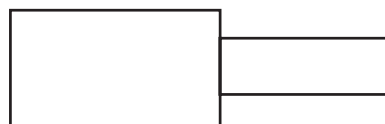

$\leftarrow 3\frac{1}{4}$  inches  $\rightarrow$   $\leftarrow 2\frac{2}{3}$  inches  $\rightarrow$

## Finding a Fraction of an Amount

1) Work out these amounts.

a)  $\frac{3}{4}$  of £20    **£15**      b)  $\frac{2}{3}$  of 60 kg    **40 kg**      c)  $\frac{3}{8} \times 24$     **9**

d)  $150 \times \frac{2}{3}$     **100**      e)  $\frac{2}{9}$  of 180 cm    **40 cm**      f)  $49 \times \frac{4}{7}$     **28**

g)  $60 \times \frac{1}{4}$     **15**      h)  $\frac{5}{8}$  of £48    **£30**      i)  $4000 \times \frac{7}{8}$     **3 500**

2) There are 600 apples on a tree and there are maggots in  $\frac{3}{5}$  of them.

How many apples have maggots in them?    **360 apples**

3) Liz and Lee are travelling in a car from Glasgow to Poole (770 km).

At midday they had already travelled  $\frac{5}{7}$  of the total distance.

What distance, in km, had they travelled by midday?    **550 km**

4) A digital camera that cost £49 was sold on eBay for  $\frac{3}{7}$  of the original price.

What was the selling price?    **£21**

5) Yesterday Thomas travelled a total of 175 miles.

He travelled  $\frac{2}{5}$  of this distance in the morning.

How many miles did he travel during the rest of the day?    **105 miles**

6) Debra received her £15 pocket money on Saturday.

She spent  $\frac{1}{3}$  of her pocket money on magazines.

She spent  $\frac{2}{5}$  of her pocket money on a necklace.

How much of the £15 did she have left?    **£4**



*In all the questions on this page, please give your answers in their simplest form.*

1) Work out the following:

a)  $\frac{1}{2} \times \frac{1}{2} = \frac{1}{4}$

b)  $\frac{2}{3} \times \frac{1}{3} = \frac{2}{9}$

c)  $\frac{3}{5} \times \frac{2}{7} = \frac{6}{35}$

d)  $\frac{4}{7} \times \frac{5}{9} = \frac{20}{63}$

2) Work out the following:

a)  $\frac{1}{2} \times \frac{2}{3} = \frac{1}{3}$

b)  $\frac{3}{4} \times \frac{8}{11} = \frac{6}{11}$

c)  $\frac{2}{9} \times \frac{3}{4} = \frac{1}{6}$

d)  $\frac{4}{5} \times \frac{1}{12} = \frac{1}{15}$

3) Work out the following:

a)  $1\frac{1}{2} \times \frac{1}{3} = \frac{1}{2}$

b)  $\frac{2}{3} \times 2\frac{2}{5} = 1\frac{3}{5}$

c)  $3\frac{1}{2} \times 1\frac{1}{2} = 5\frac{1}{4}$

d)  $1\frac{2}{7} \times 3\frac{1}{3} = 4\frac{2}{7}$

*In all the questions on this page, please give your answers in their simplest form.*

1) Work out the following:

a)  $\frac{2}{5} \div \frac{3}{4} = \frac{8}{15}$

b)  $\frac{1}{7} \div \frac{3}{5} = \frac{5}{21}$

c)  $\frac{4}{9} \div \frac{1}{2} = \frac{8}{9}$

d)  $\frac{3}{10} \div \frac{5}{9} = \frac{27}{50}$

2) Work out the following:

a)  $\frac{1}{2} \div \frac{1}{3} = 1\frac{1}{2}$

b)  $\frac{3}{7} \div \frac{4}{7} = \frac{3}{4}$

c)  $\frac{1}{9} \div \frac{2}{3} = \frac{1}{6}$

d)  $\frac{2}{5} \div \frac{3}{10} = 1\frac{1}{3}$

3) Work out the following:

a)  $1\frac{1}{3} \div \frac{1}{4} = 5\frac{1}{3}$

b)  $\frac{3}{5} \div 2\frac{2}{3} = \frac{9}{40}$

c)  $3\frac{2}{3} \div 1\frac{1}{5} = 3\frac{1}{18}$

d)  $4\frac{1}{2} \div 1\frac{1}{2} = 3$

- 1)  $6 \times 5 + 2$  32
- 2)  $2 + 6 \times 5$  32
- 3)  $35 - 4 \times 3$  23
- 4)  $48 \div (14 - 2)$  4
- 5)  $27 \div (3 + 6)$  3
- 6)  $27 \div 3 + 6$  15
- 7)  $(9 + 2) \times 2 + 5$  27
- 8)  $4 \times (1 + 4) - 6$  14
- 9)  $6 \times 4 - 3 \times 5$  9
- 10)  $\frac{9+3}{4+2}$  2
- 11)  $\frac{23+9}{7-3}$  8
- 12)  $\frac{7-2^2}{4^2-15}$  3
- 13)  $\frac{5^2+3}{2 \times 7}$  2
- 14)  $\frac{5 \times 6 - 4}{13}$  2
- 15)  $\frac{8 \times 2 - 4}{3 + 1^2}$  3
- 16)  $\frac{12 - 3 \times 2}{14 \div 7}$  3
- 17)  $\frac{20 - 3^2}{10 - (5 + 4)}$  11
- 18)  $\frac{3 + 9 \times 8}{1 + 6 \times 4}$  3

1) Write down the reciprocal of

a) 8      $\frac{1}{8}$

b) 3      $\frac{1}{3}$

c) 1     1

d) 12     $\frac{1}{12}$

2) Write down the reciprocal of

a)  $\frac{1}{2}$     2

b)  $\frac{1}{3}$     3

c)  $\frac{4}{3}$      $\frac{3}{4}$

d)  $\frac{5}{8}$      $\frac{8}{5}$

3) Write down the reciprocal of

a) 0.1    10

b) 0.5    2

c) 0.2    5

4) Why can't we have a reciprocal of 0? **Because division by "0" does not exist.**



1) Use your calculator to work out

$$\frac{23.7 \times 14.2}{8.4 \times 3.2} \quad 12.52008929$$

Write down all the figures on your calculator display.



2) Use your calculator to work out

$$\frac{\sqrt{21.4}}{5.7 - 2.35} \quad 1.380899523$$

Write down all the figures on your calculator display.



3) Work out  $\frac{5.8 + 4.65}{3.1^2 + 1.62}$  0.9305431879

Write down all the figures on your calculator display.



4) Use your calculator to work out the value of

$$\frac{9.2 \times 16.3}{9.4 - 5.71} \quad 40.6395664$$

Write down all the digits from your calculator.  
Give your answer as a decimal.



5) Use your calculator to work out

$$\frac{3}{2.1 + 3.45} \quad 0.5405405405$$

Write down all the figures on your calculator display.  
You must give your answer as a decimal.



6) Use your calculator to work out

$$\frac{15^2 - 12^2}{\sqrt{9.6 - 3.87}} \quad 33.83823544$$

Write down all the figures on your calculator display.  
You must give your answer as a decimal.



7) Use a calculator to work out

$$\sqrt{\frac{22.4 \times 13.9}{3.6}} \quad 9.299940263$$

Write down all the figures on your calculator display.

- 1) List the first seven prime numbers.     **2, 3, 5, 7, 11, 13, 17**
  
- 2) Express the following numbers as the product of their prime factors:
  - a) 12      **$2 \times 2 \times 3$**
  - b) 20      **$2 \times 2 \times 5$**
  - c) 30      **$2 \times 3 \times 5$**
  - d) 24      **$2 \times 2 \times 2 \times 3$**
  
- 3) Express the following numbers as the product of their prime factors:
  - a) 64      **$2 \times 2 \times 2 \times 2 \times 2 \times 2$**
  - b) 100     **$2 \times 2 \times 5 \times 5$**
  - c) 150     **$2 \times 3 \times 5 \times 5$**
  
- 4) Express the following numbers as the product of their prime factors:
  - a) 175     **$5 \times 5 \times 7$**
  - b) 192     **$2 \times 2 \times 2 \times 2 \times 2 \times 2 \times 3$**
  - c) 315     **$3 \times 3 \times 5 \times 7$**
  
- 5) The number 96 can be written as  $2^m \times n$ , where  $m$  and  $n$  are prime numbers.  
Find the value of  $m$  and the value of  $n$ .      **$m = 5$  and  $n = 3$**
  
- 6) The number 75 can be written as  $5^x \times y$ , where  $x$  and  $y$  are prime numbers.  
Find the value of  $x$  and the value of  $y$ .      **$x = 2$  and  $y = 3$**

- 1) Find the Highest Common Factor of 16 and 24.

8

- 2) Find the Highest Common Factor of 21 and 28.

7

- 3) Find the Highest Common Factor of 60 and 150.

30

- 4) Find the Highest Common Factor of 96 and 108.

12

- 5) (i) Write 42 and 63 as products of their prime factors.  $42 = 2 \times 3 \times 7$   
 $63 = 3 \times 3 \times 7$
- (ii) Work out the Highest Common Factor of 42 and 63.

21

## Lowest Common Multiple (LCM)

- 1) Find the Lowest Common Multiple of 20 and 60.

60

- 2) Find the Lowest Common Multiple of 28 and 72.

504

- 3) Find the Lowest Common Multiple of 70 and 240.

1680

- 4) Find the Lowest Common Multiple of 35 and 55.





385

- 5) (i) Write 42 and 63 as products of their prime factors.  $42 = 2 \times 3 \times 7$   
 $63 = 3 \times 3 \times 7$
- (ii) Work out the Lowest Common Multiple of 42 and 63.

126



## Product of Primes/HCF/LCM

- 1) a) Express 84 as a product of its prime factors.  $2 \times 2 \times 3 \times 7$   
b) Find the Highest Common Factor (HCF) of 84 and 35.  $7$
- 2) Express 72 as the product of its prime factors.  $2 \times 2 \times 2 \times 3 \times 3$
- 3) Express 180 as the product of its prime factors.  $2 \times 2 \times 3 \times 3 \times 5$
- 4) a) Express 66 as a product of its prime factors.  $2 \times 3 \times 11$   
b) Express  $132^2$  as a product of its prime factors.  $2 \times 2 \times 2 \times 2 \times 3 \times 3 \times 11 \times 11$
-  5) Express 252 as a product of its prime factors.  $2 \times 2 \times 3 \times 3 \times 7$
-  6) Find the Lowest Common Multiple (LCM) of 24 and 36.  $72$
-  7) a) Write 56 as a product of its prime factors.  $2 \times 2 \times 2 \times 7$   
b) Find the Highest Common Factor (HCF) of 56 and 42.  $14$
-  8) a) Express 45 as a product of its prime factors.  $3 \times 3 \times 5$   
b) Find the Highest Common Factor (HCF) of 45 and 30.  $15$
-  9) a) Find the Highest Common Factor (HCF) of 24 and 30.  $6$   
b) Find the Lowest Common Multiple (LCM) of 4, 5 and 6.  $60$

- 1) What is the value of  $5^2$ ? **25**
- 2) What is the value of  $8^2$ ? **64**
- 3) These are the first five square numbers: 1, 4, 9, 16, 25
  - a) What is the sixth square number? **36**
  - b) What is the 10th square number? **100**
- 4) Which square number lies between 60 and 70?  **$8^2 = 64$**
- 5) What is the value of  $2^3$ ? **8**
- 6) What is the value of  $4^3$ ? **64**
- 7) Work out  $1^3 + 2^3 + 3^3$  **36**
- 8) Work out  $\sqrt{25}$  **5**
- 9) Work out  $\sqrt{49}$  **7**
- 10) Work out the value of  $\sqrt{121} \times \sqrt{121}$  **121**
- 11) Match together cards with the same answer

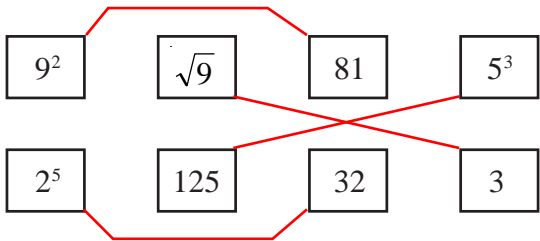

1) Evaluate the following:

a)  $2^3$  **8**

b)  $3^2$  **9**

c)  $10^4$  **10000**

2) Evaluate the following:

a)  $2^8$  **256**

b)  $6^4$  **1296**

c)  $5^6$  **15625**

3) Find the value of

a)  $2^4 + 3^2$  **25**

b)  $5^2 - 2^3$  **17**

c)  $1^2 + 2^2 + 3^2$  **14**

4) Find the value of

a)  $5^4 + 6^3$  **841**

b)  $3^4 \times 2^5$  **2592**

c)  $9^3 - 6^3$  **513**

5) Find the value of

$2^2 + 3^2 + 5^2 + 7^2 + 11^2 + 13^2 + 17^2$  **666**

1) Change the following to normal (or ordinary) numbers.

a)  $4.3 \times 10^4$   
43 000

c)  $7.03 \times 10^3$   
7 030

e)  $1.01 \times 10^4$   
10 100

b)  $6.79 \times 10^6$   
6 790 000

d)  $9.2 \times 10^2$   
920

f)  $4 \times 10^5$   
400 000

2) Change the following to normal (or ordinary) numbers.

a)  $4.3 \times 10^{-4}$   
0.00043

c)  $7.03 \times 10^{-3}$   
0.00703

e)  $1.01 \times 10^{-4}$   
0.000101

b)  $6.79 \times 10^{-6}$   
0.00000679

d)  $9.2 \times 10^{-2}$   
0.092

f)  $4 \times 10^{-5}$   
0.00004

3) Change the following to standard form.

a) 360  
 $3.6 \times 10^2$

c) 520 000  
 $5.2 \times 10^5$

e) 1 003  
 $1.003 \times 10^3$

b) 8 900  
 $8.9 \times 10^3$

d) 60000  
 $6 \times 10^4$

f) 6 450 000  
 $6.45 \times 10^6$

4) Change the following to standard form.

a) 0.071  
 $7.1 \times 10^{-2}$

c) 0.00076  
 $7.6 \times 10^{-4}$

e) 0.00009  
 $9 \times 10^{-5}$

b) 0.0008  
 $8 \times 10^{-4}$

d) 0.0928  
 $9.28 \times 10^{-2}$

f) 0.00000173  
 $1.73 \times 10^{-6}$

5) Work out the following, giving your answer in standard form.

a)  $3\ 000 \times 5\ 000$   
 $1.5 \times 10^7$

d)  $5 \times 4 \times 10^3$   
 $2 \times 10^4$

g)  $7 \times 10^2 \times 3 \times 10^{-4}$   
 $2.1 \times 10^{-1}$

b)  $240 \times 0.0002$   
 $4.8 \times 10^{-2}$

e)  $\frac{8 \times 10^4}{4 \times 10^2}$   
 $2 \times 10^2$

h)  $2 \times 3.6 \times 10^{-5}$   
 $7.2 \times 10^{-5}$

c)  $9 \times 1.1 \times 10^7$   
 $9.9 \times 10^7$

f)  $9 \times 10^2 \times 2 \times 10^{-5}$   
 $1.8 \times 10^{-2}$

i)  $6 \times 4.1 \times 10^3$   
 $2.46 \times 10^4$

Write the following fractions as decimals

1)  $\frac{3}{10}$  0.3

2)  $\frac{7}{10}$  0.7

3)  $\frac{9}{100}$  0.09

4)  $\frac{1}{2}$  0.5

5)  $\frac{3}{4}$  0.75

6)  $\frac{2}{5}$  0.4

7)  $\frac{7}{20}$  0.35

8)  $\frac{1}{3}$  0.3

9)  $\frac{1}{8}$  0.125

10)  $\frac{5}{8}$  0.625

1) Write the following fractions as decimals and percentages:

eg.  $\frac{1}{10} \xrightarrow{1 \div 10} 0.1 \xrightarrow{0.1 \times 100} 10\%$

a)  $\frac{3}{10} = 0.3 = 30\%$

b)  $\frac{1}{5} = 0.2 = 20\%$

c)  $\frac{2}{5} = 0.4 = 40\%$

d)  $\frac{1}{4} = 0.25 = 25\%$

e)  $\frac{3}{4} = 0.75 = 75\%$

f)  $\frac{1}{2} = 0.5 = 50\%$

g)  $\frac{1}{3} = 0.3 = 33.3\%$

2) Fill in the blanks in the table below:

Fraction	Decimal	Percentage
$\frac{6}{10}$	0.6	60%
$\frac{1}{5}$	0.2	20%
$\frac{9}{10}$	0.9	90%
$\frac{2}{5}$	0.4	40%
$\frac{1}{4}$	0.25	25%
$\frac{4}{5}$	0.8	80%
$\frac{12}{100}$	0.12	12%
$\frac{1}{3}$	0.3	33.3%
$\frac{7}{10}$	0.7	70%



1) Work out:

- a) 21% of £340 **£71.40**
- b) 64% of £1080 **£691.20**
- c) 36% of £800 **£288**
- d) 98% of £13 **£12.74**



2) Work out:

- a) 17.5% of £58 **£10.15**
- b) 20% of £5.40 **£1.08**
- c) 61.7% of £2000 **£1234**
- d) 17.5% of £68.40 **£11.97**



3) A computer costs £406 plus VAT at 20%.

Work out the total cost of the computer. **£487.20**



4) A car is usually priced at £9800 but now has a discount of 8%.

What is the new price of the car? **£9016**



5) 9500 people attend a festival and 22% of them are children.

How many children are at the festival? **2090**



6) 65% of a car, by weight, is steel and iron.

If a car weighs 1100 kg, what is the weight of steel and iron in the car? **715 kg**



7) Tony earns £17800 per year and receives a 3.8% pay rise.

How much does he now earn? **£18476.40**

- 1) Work out:
- a) 10% of £170    **£17**
  - b) 10% of £6800    **£680**
  - c) 10% of £923    **£92.30**
  - d) 10% of £16    **£1.60**
- 2) Work out:
- a) 20% of £60    **£12**
  - b) 30% of £90    **£27**
  - c) 15% of £800    **£120**
  - d) 15% of £68    **£10.20**
- 3) Work out:
- a) 35% of £80    **£28**
  - b) 90% of £160    **£144**
  - c) 17.5% of £600    **£105**
  - d) 17.5% of £850    **£148.75**
- 4) Work out:
- a) 15% of £4.60    **£0.69**
  - b) 40% of £2.80    **£1.12**
  - c) 17.5% of £3.20    **£0.56**
  - d) 97.5% of £24    **£23.40**
- 5) The normal price of a jacket is £54.  
In a sale, the price is reduced by 30%  
What is the sale price?    **£37.80**
- 6) A football costs £14 plus 20% VAT.  
How much is the football?    **£16.80**



## Change to a Percentage with a Calculator



1) Write the following as percentages, giving all your answers to 1 decimal place.

- a) 12 out of 34 **35.3%**  
b) 62 out of 85 **72.9%**  
c) 113 out of 153 **73.9%**  
d) 2150 out of 3452 **62.3%**



2) Sarah sat a Science test and got a score of 64 marks out of 112 possible marks.

What was her mark as a percentage?  
Give your answer to 1 decimal place. **57.1%**



3) In a class of 32 students, 18 of them are boys.

What percentage of the class are boys?  
Give your answer to 1 decimal place. **56.3%**



4) In a French class there are 13 girls and 6 boys.

What percentage of the class are girls?  
Give your answer to 1 decimal place. **68.4%**



5) A new car usually costs £8500.

Henry gets a discount of £1000.

What is the discount as a percentage of the usual cost?  
Give your answer to 1 decimal place. **11.8%**



6) Write out £148 as a percentage of £600.

Give your answer to 1 decimal place. **24.7%**



7) In a wood there are 200 oak trees, 650 silver birch trees and 400 wild cherry trees.

What percentage of the trees are oak trees? **16%**



8) In England in 2010 there were 68820 deaths caused by cancer.

Of these deaths, 37500 were caused by smoking.

What percentage of deaths due to cancer were caused by smoking?  
Give your answer to 1 decimal place. **54.5%**

## Change to a Percentage without a Calculator

- 1) Write the following as percentages.
  - a) 12 out of 50    **24%**
  - b) 15 out of 25    **60%**
  - c) 8 out of 10    **80%**
  - d) 11 out of 20    **55%**
  - e) 4 out of 5    **80%**
  - f) 32 out of 40    **80%**
  - g) 12 out of 80    **15%**
  - h) 640 out of 800    **80%**
  - i) 36 out of 60    **60%**
  
- 2) Tim got 17 out of 20 in a French test.  
Write 17 out of 20 as a percentage.    **85%**
  
- 3) Write £19 as a percentage of £25    **76%**
  
- 4) Work out £14 as a percentage of £40    **35%**
  
- 5) A baker burnt 12 loaves out of the 200 loaves he baked.  
What percentage of the 200 loaves did he burn?    **6%**
  
- 6) What is £380 as a percentage of £400?    **95%**
  
- 7) What is £22 as a percentage of £40?    **55%**
  
- 8) If there are 9 girls and 11 boys in a class, what percentage of the class are girls?    **45%**

## Percentages



- 1) Find the following to the nearest penny:
- 23% of £670 **£154.10**
  - 12% of £580 **£69.60**
  - 48% of £64 **£30.72**
  - 13% of £7.50 **£0.98**
  - 87% of £44 **£38.28**
  - 15.7% of £7000 **£1099**
  - 23.8% of £980 **£233.24**
  - 34% of £16.34 **£5.56**
  - 48.6% of £971.26 **£472.03**
  - 78.24% of £12.82 **£10.03**
  - 42.15% of £7876.42 **£3319.91**
  - 0.57% of £60000 **£342**

- 2) Find the following:
- 10% of £700 **£70**
  - 10% of £400 **£40**
  - 10% of £350 **£35**
  - 10% of £530 **£53**
  - 10% of £68 **£6.80**
  - 10% of £46 **£4.60**
  - 10% of £6.50 **£0.65**
  - 10% of £12.20 **£1.22**
  - 20% of £600 **£120**
  - 30% of £900 **£270**
  - 60% of £800 **£480**
  - 20% of £650 **£130**
  - 40% of £320 **£128**
  - 15% of £300 **£45**
  - 15% of £360 **£54**
  - 65% of £12000 **£7800**
  - 45% of £64 **£28.80**
  - 85% of £96 **£81.60**
  - 17.5% of £800 **£140**
  - 17.5% of £40 **£7**
  - 17.5% of £8.80 **£1.54**



- 3) Change the following to percentages, giving all answers to 1 decimal place:
- 6 out of 28 **21.4%**
  - 18 out of 37 **48.6%**
  - 42 out of 83 **50.6%**
  - 24 out of 96 **25%**
  - 73 out of 403 **18.1%**
  - 234 out of 659 **35.5%**
  - 871 out of 903 **96.5%**
  - 4.7 out of 23 **20.4%**
  - 6.9 out of 79 **8.7%**
  - 14.8 out of 23.6 **62.7%**
  - 65.8 out of 203.7 **32.3%**

- 4) Change the following to percentages:
- 46 out of 100 **46%**
  - 18 out of 50 **36%**
  - 7 out of 25 **28%**
  - 23 out of 25 **92%**
  - 9 out of 20 **45%**
  - 16 out of 20 **80%**
  - 7 out of 10 **70%**
  - 9.5 out of 10 **95%**
  - 10 out of 40 **25%**
  - 16 out of 40 **40%**
  - 30 out of 40 **75%**
  - 12 out of 40 **30%**
  - 28 out of 80 **35%**
  - 32 out of 80 **40%**
  - 60 out of 80 **75%**
  - 3 out of 5 **60%**
  - 4 out of 5 **80%**
  - 15 out of 75 **20%**
  - 24 out of 75 **32%**
  - 30 out of 75 **40%**

- 5) A shop gives a discount of 20% on a magazine that usually sells for £2.80. Work out the discount in pence. **56p**



- 6) A television costs £596 plus VAT at 17.5%. Work out the cost of the television including VAT. **£700.30**



- 7) Peter has 128 trees in his garden. 16 of the trees are pear trees. What percentage of the trees in his garden are pear trees? **12.5%**



- 8) Jane scored 27 out of 42 in a Maths test and 39 out of 61 in a Science test. What were her percentages in both subjects to 1 decimal place? **Maths: 64.3%**  
**Science: 63.9%**

- 9) In class 9A there are 7 girls and 18 boys. What percentage of the class are girls? **28%**

- 10) A shop decides to reduce all the prices by 15%. The original price of a pair of trainers was £70. How much are they after the reduction? **£59.50**



- 11) VAT at 17.5% is added to the price of a car. Before the VAT is added it cost £18000. How much does it cost with the VAT? **£21150**

## Rounding to Significant Figures

1) Round the following numbers to 1 significant figure:

- a) 428 **400**
- b) 783 **800**
- c) 5608 **6000**
- d) 3521 **4000**
- e) 21999 **20000**
- f) 793041 **800000**

2) Round the following numbers to 2 significant figures:

- a) 846 **850**
- b) 2647 **2600**
- c) 3552 **3600**
- d) 46817 **47000**
- e) 89711 **90000**
- f) 195084 **200000**

3) Round the following numbers to 3 significant figures:

- a) 91249 **91200**
- b) 64182 **64200**
- c) 223058 **223000**
- d) 389512 **390000**
- e) 7761223 **7760000**
- f) 4997124 **5000000**



4) Work out the following and give your answer to 3 significant figures:

- a)  $216 \times 348$  **75200**
- b)  $7721 \times 609$  **4700000**
- c)  $8714 \times 2198$  **19200000**

5) Round the following numbers to 1 significant figure:

- a) 0.00618 **0.006**
- b) 0.00482 **0.005**
- c) 0.00006492 **0.00006**
- d) 0.004981 **0.005**

6) Round the following numbers to 2 significant figures:

- a) 0.035812 **0.036**
- b) 0.00082477 **0.00082**
- c) 0.0038611 **0.0039**
- d) 0.000037211 **0.000037**

7) Round the following numbers to 3 significant figures:

- a) 0.00143229 **0.00143**
- b) 0.000721981 **0.000722**
- c) 0.0000044251 **0.00000443**
- d) 0.000668821 **0.000669**

8) Round the following numbers to 3 significant figures:

- a) 47.84122 **47.8**
- b) 9.778112 **9.78**
- c) 12.35913 **12.4**



9) Work out the following and give your answer to 3 significant figures:

- a)  $15 \div 0.38$  **39.5**
- b)  $0.31 \div 0.16$  **1.94**
- c)  $208 \times 366$  **76100**

1) Work out an estimate for  $\frac{304 \times 9.96}{0.51}$  **6000**

2) Work out an estimate for  $\frac{6.7 \times 192}{0.051}$  **28000**

3) Work out an estimate for  $\frac{32 \times 4.92}{0.21}$  **750**

4) Work out an estimate for  $\frac{3880}{236 \times 4.85}$  **4**

5) Work out an estimate for  $\frac{7.18 \times 19.7}{0.47}$  **280**

1) Using the information that

$$4.7 \times 34 = 159.8$$

write down the value of

a)  $47 \times 34$  **1598**

b)  $4.7 \times 3.4$  **15.98**

c)  $159.8 \div 47$  **3.4**

2) Using the information that

$$324 \times 48 = 15552$$

write down the value of

a)  $3.24 \times 4.8$  **15.552**

b)  $0.324 \times 0.48$  **0.15552**

c)  $15552 \div 4.8$  **3240**

3) Using the information that

$$73 \times 234 = 17082$$

write down the value of

a)  $730 \times 234$  **170820**

b)  $73 \times 2.34$  **170.82**

4) Using the information that

$$27 \times 5.6 = 151.2$$

write down the value of

a)  $27 \times 56$  **1512**

b)  $2.7 \times 0.56$  **1.512**

c)  $151.2 \div 56$  **2.7**

5) Using the information that

$$719 \times 35 = 25165$$

write down the value of

a)  $71.9 \times 3.5$  **251.65**

b)  $0.719 \times 0.35$  **0.25165**

c)  $25165 \div 7.19$  **3500**

1) Expand these brackets

a)  $2(x + 3)$      $2x + 6$

b)  $3(2x + 4)$      $6x + 12$

c)  $5(3p - 2q)$      $15p - 10q$

d)  $4(x^2 + 2y^2)$      $4x^2 + 8y^2$

e)  $6(r - r^2)$      $6r - 6r^2$

2) Expand these brackets

a)  $x(x - 2)$      $x^2 - 2x$

b)  $x(3x + 5)$      $3x^2 + 5x$

c)  $p(3p - 7q)$      $3p^2 - 7pq$

d)  $y(y + 6y^2)$      $y^2 + 6y^3$

e)  $x(r + r^2)$      $xr + xr^2$

3) Expand these brackets

a)  $2x(x - 5)$      $2x^2 - 10x$

b)  $4x(2x + 3)$      $8x^2 + 12x$

c)  $5p(4p - 2q)$      $20p^2 - 10pq$

d)  $2y(3y + 4x^2)$      $6y^2 + 8x^2y$

e)  $x(x + r^2)$      $x^2 + r^2x$

4) Expand these brackets

a)  $x(x^2 - 2)$      $x^3 - 2x$

b)  $3x(2x^3 + 1)$      $6x^4 + 3x$

c)  $5p^2(4p - 2)$      $20p^3 - 10p^2$

d)  $2y^2(3y^3 + 4y)$      $6y^5 + 8y^3$

e)  $2xy(x + y^2)$      $2x^2y + 2xy^3$

## Simple Factorisation

1) Factorise

a)  $2x + 4$       $2(x + 2)$

b)  $2y + 10$       $2(y + 5)$

c)  $3x + 12$       $3(x + 4)$

d)  $3x - 6$       $3(x - 2)$

e)  $5x - 15$       $5(x - 3)$

2) Factorise

a)  $p^2 + 7p$       $p(p + 7)$

b)  $x^2 + 4x$       $x(x + 4)$

c)  $y^2 - 2y$       $y(y - 2)$

d)  $p^2 - 5p$       $p(p - 5)$

e)  $x^2 + x$       $x(x + 1)$

3) Factorise

a)  $2x^2 + 6x$       $2x(x + 3)$

b)  $2y^2 - 8y$       $2y(y - 4)$

c)  $5p^2 + 10p$       $5p(p + 2)$

d)  $7c^2 - 21c$       $7c(c - 3)$

e)  $6x^2 + 9x$       $3x(2x + 3)$

4) Factorise

a)  $2x^2 - 4xy$       $2x(x - 2y)$

b)  $2t^2 + 10tu$       $2t(t + 5u)$

c)  $6x^2 - 8xy$       $2x(3x - 4y)$

d)  $3x^2y^2 + 9xy$       $3xy(xy + 3)$



## Substitution

- 1)  $y = 5x$   
 a) Work out the value of  $y$  when  $x = 3$  **15**  
 b) Work out the value of  $y$  when  $x = -2$  **-10**
- 2)  $y = 2x + 7$   
 a) Work out the value of  $y$  when  $x = 4$  **15**  
 b) Work out the value of  $y$  when  $x = -3$  **1**
- 3)  $y = 2x + 4t$   
 $x = 6$   
 $t = 1$   
 Work out the value of  $y$ . **16**
- 4)  $y = 2a - 3b$   
 $a = 4$   
 $b = -2$   
 Work out the value of  $y$ . **14**
- 5)  $v = 3a + 5b$   
 $a = 6$   
 $b = -3$   
 Work out the value of  $v$ . **3**
- 6)  $y = x^2$   
 a) Work out the value of  $y$  when  $x = 6$  **36**  
 b) Work out the value of  $y$  when  $x = -4$  **16**
- 7)  $y = 2x^2$   
 a) Work out the value of  $y$  when  $x = 5$  **50**  
 b) Work out the value of  $y$  when  $x = -3$  **18**
- 8)  $y = 3x^2 + 2x$   
 a) Work out the value of  $y$  when  $x = 2$  **16**  
 b) Work out the value of  $y$  when  $x = -4$  **40**



- 9)  $v = u^2 + 5as$   
 $u = 6$   
 $a = 2.5$   
 $s = 9$

Work out the value of  $v$ . **148.5**



- 10)  $y = p - 2qx^2$   
 $p = -10$   
 $q = 2$   
 $x = -5$

Work out the value of  $y$ . **-110**



- 11)  $v^2 = u^2 + 2as$   
 $u = 6$   
 $a = 2.5$   
 $s = 9$

Work out the value of  $v$ . **9**



- 12)  $v^2 = u^2 + 2as$   
 $u = 3$   
 $a = 9.8$   
 $s = 12$

Work out the value of  $v$ . **15.6**  
 Give your answer correct to 1 decimal place



- 13)  $s = ut + 0.5at^2$   
 $a = 9.8$   
 $t = 5$   
 $u = 7$

Work out the value of  $s$ . **157.5**

# Straight Line Graphs

1) a) Complete the table of values for  $y = 4x - 2$

x	-2	-1	0	1	2	3
y	-10	-6	-2	2	6	10

b) On the grid, draw the graph of  $y = 4x - 2$ , for values of  $x$  from -2 to 3.

c) Use the graph to find the value of  $y$  when  $x = 2.5$

$y = 8$

d) Use the graph to find the value of  $x$  when  $y = -8$

$x = -1.5$

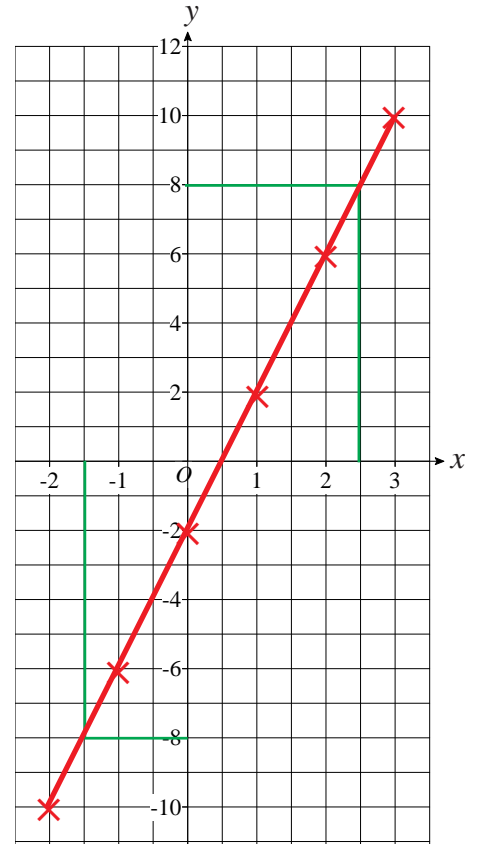

2) a) Complete the table of values for  $y = 2x + 2$

x	-2	-1	0	1	2	3
y	-2	0	2	4	6	8

b) On the grid, draw the graph of  $y = 2x + 2$ .

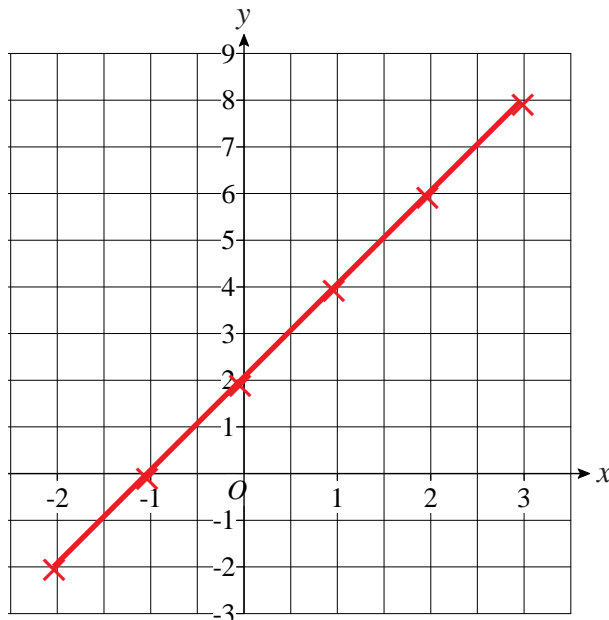

## Straight Line Graphs

1) On the grid, draw the graph of  $y = 2x - 4$

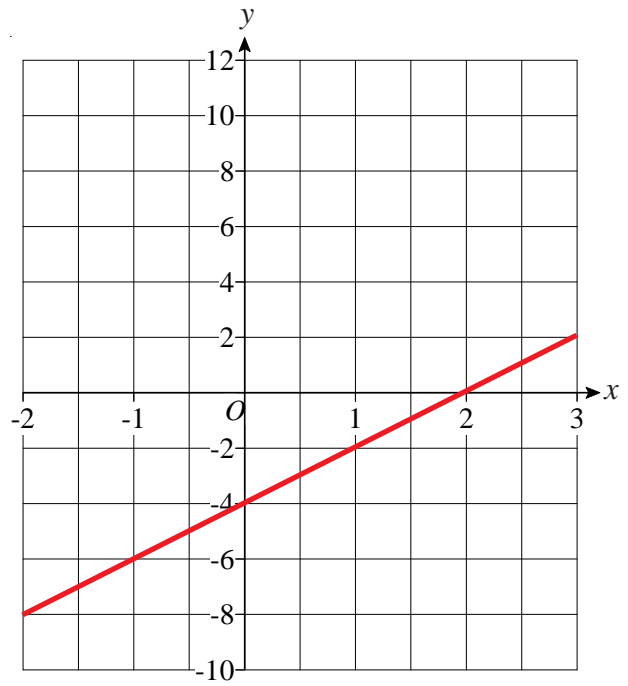

2) a) Complete the table of values for  $3x + 2y = 6$

$x$	-2	-1	0	1	2	3
$y$	6	4.5	3	1.5	0	-1.5

b) On the grid, draw the graph of  $3x + 2y = 6$

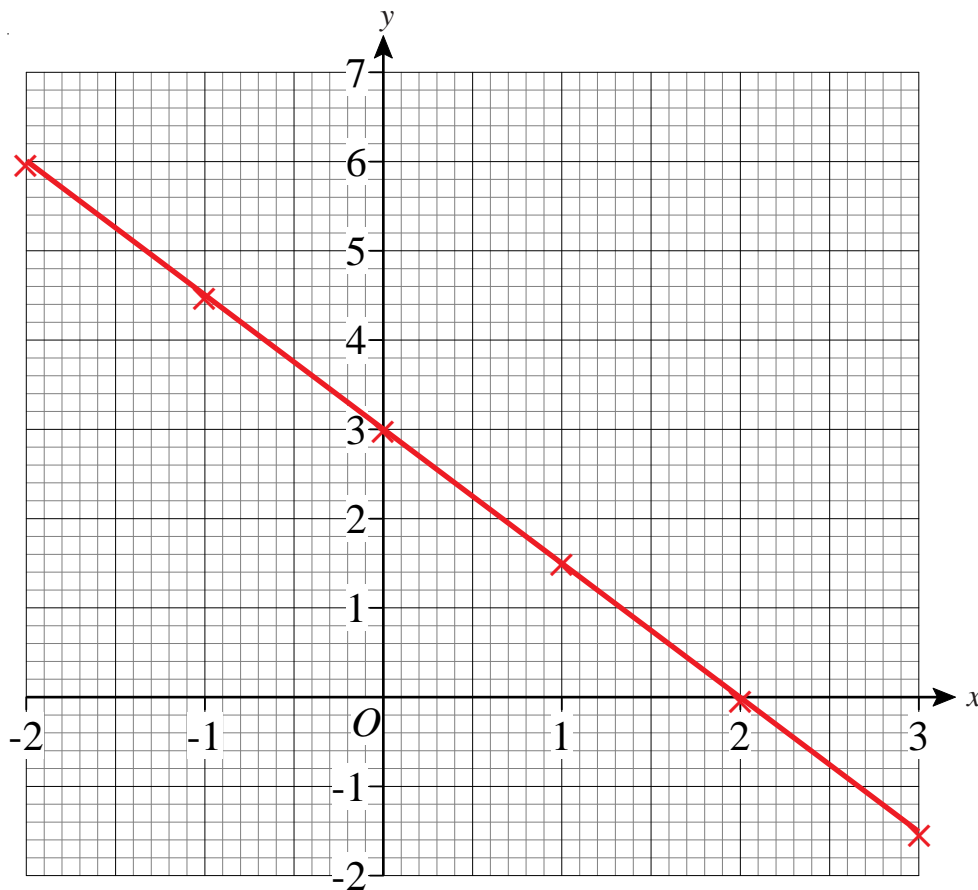

c) Find the gradient of the graph of  $3x + 2y = 6$ . Gradient is -1.5

Straight Line Graphs

1) a) Complete the table of values for  $y = 2x - 3$

x	-1	0	1	2	3	4
y	-5	-3	-1	1	3	5

- b) Using the axes on the right draw the graph of  $y = 2x - 3$
- c) Use your graph to work out the value of y when  $x = 2.5$   $y = 2$
- d) Use your graph to work out the value of x when  $y = 4.5$   $x = 3.75$

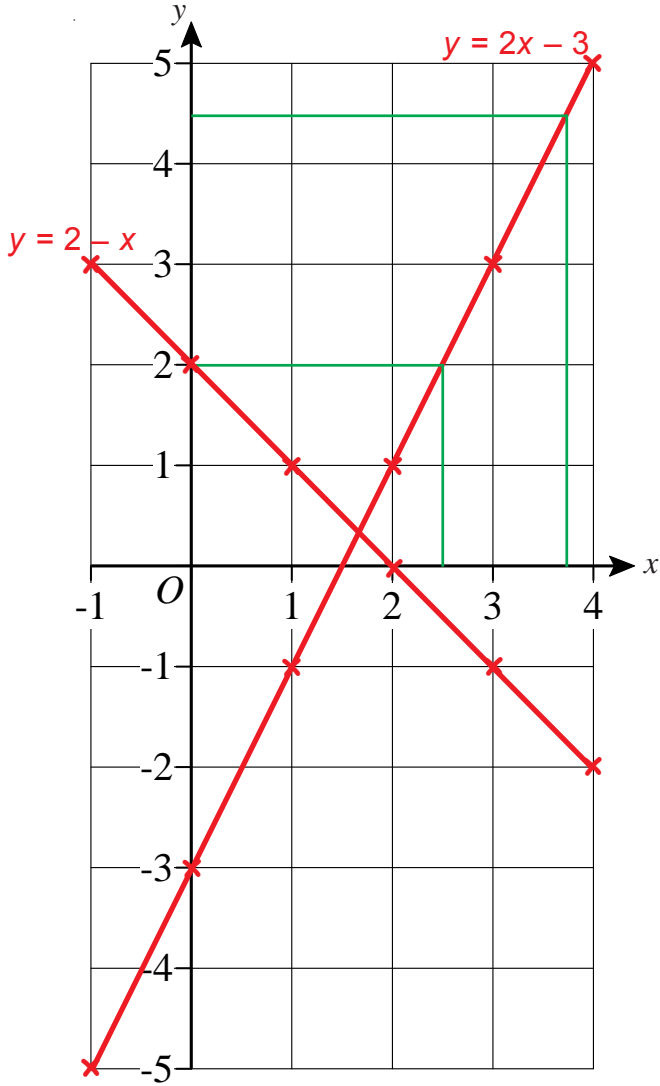

2) a) Complete the table of values for  $y = 2 - x$

x	-1	0	1	2	3	4
y	3	2	1	0	-1	-2

b) Using the axes on the right, again, draw the graph of  $y = 2 - x$

3) a) Complete the table of values for  $y = \frac{1}{2}x - 1$

x	-1	0	1	2	3	4
y	$-1\frac{1}{2}$	-1	$-\frac{1}{2}$	0	$\frac{1}{2}$	1

b) Draw the graph of  $y = \frac{1}{2}x - 1$

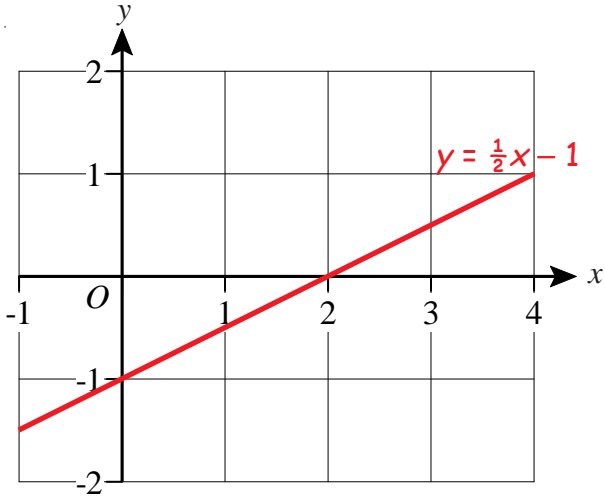

c) Use your graph to find the value of y when  $x = 3.5$   $x = 0.75$

## The Gradient of a Line

A: 2

- 1) Find the gradient of lines A, B, C and D. B: 3

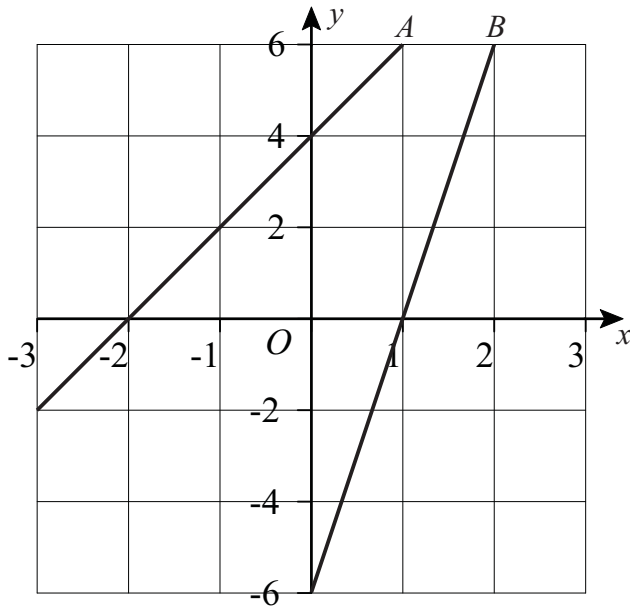

C:  $-\frac{2}{3}$

D: -10

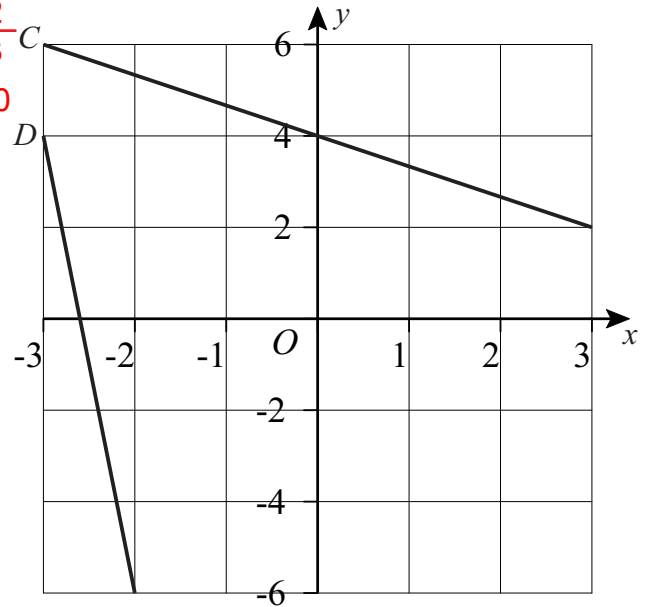

- 2) The graph shows how Meg cycles at a constant speed for 60 minutes.

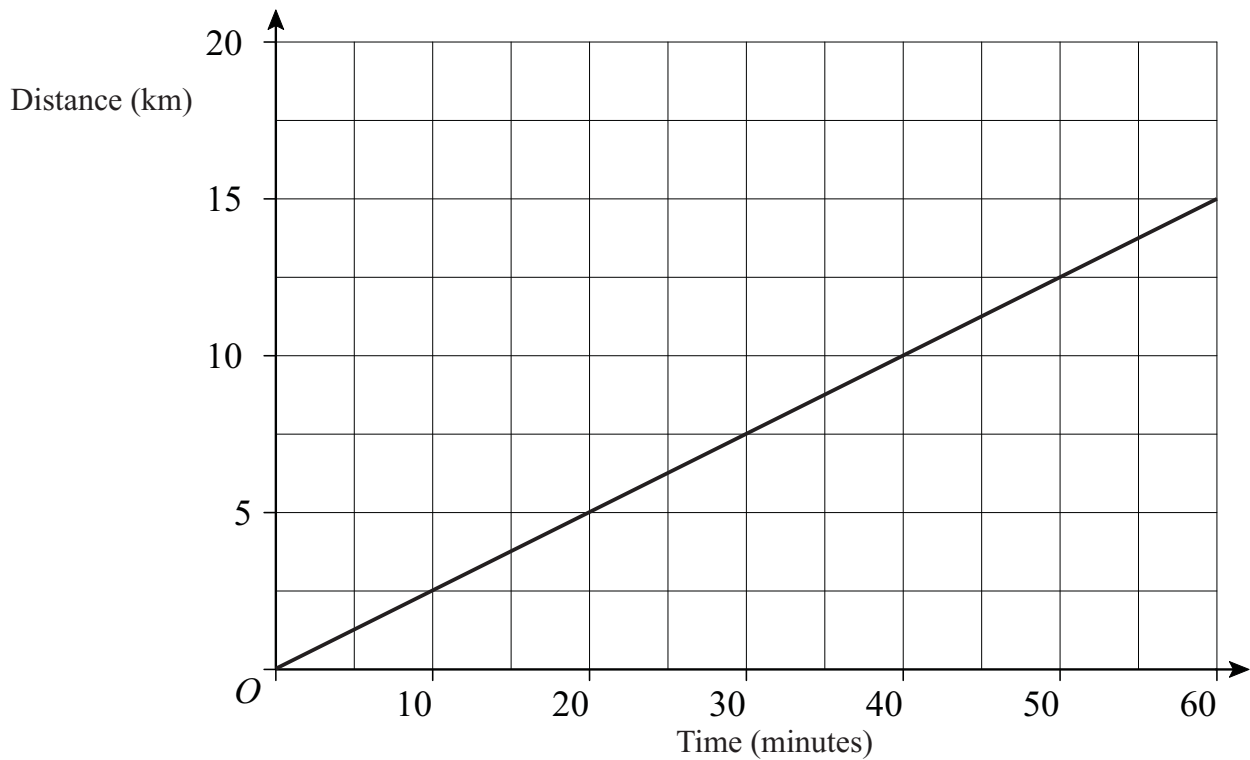

- a) Find the gradient of the line. 0.25  
b) What does the gradient show? Meg is cycling at 0.25 km per minute.

## Drawing Quadratic Graphs

1) Complete the table of values for  $y = x^2 - 4x + 3$

x	-1	0	1	2	3	4	5
y	8	3	0	-1	0	3	8

On the grid, draw the graph of  $y = x^2 - 4x + 3$

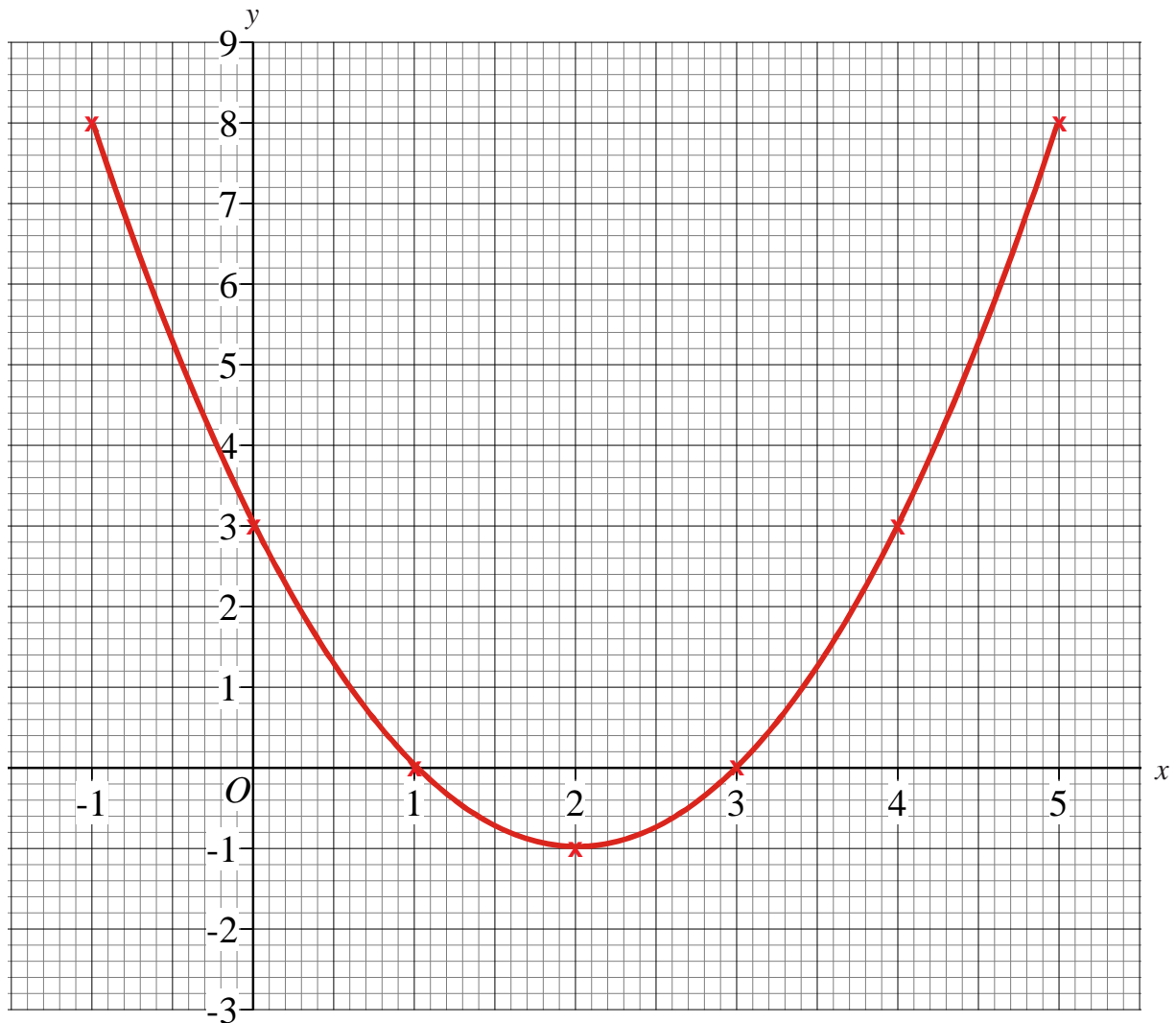

## Drawing Quadratic Graphs

1) a) Complete the table of values for  $y = x^2 - 3x - 2$

x	-2	-1	0	1	2	3	4
y	8	2	-2	-4	-4	-2	2

b) On the grid, draw the graph of  $y = x^2 - 3x - 2$

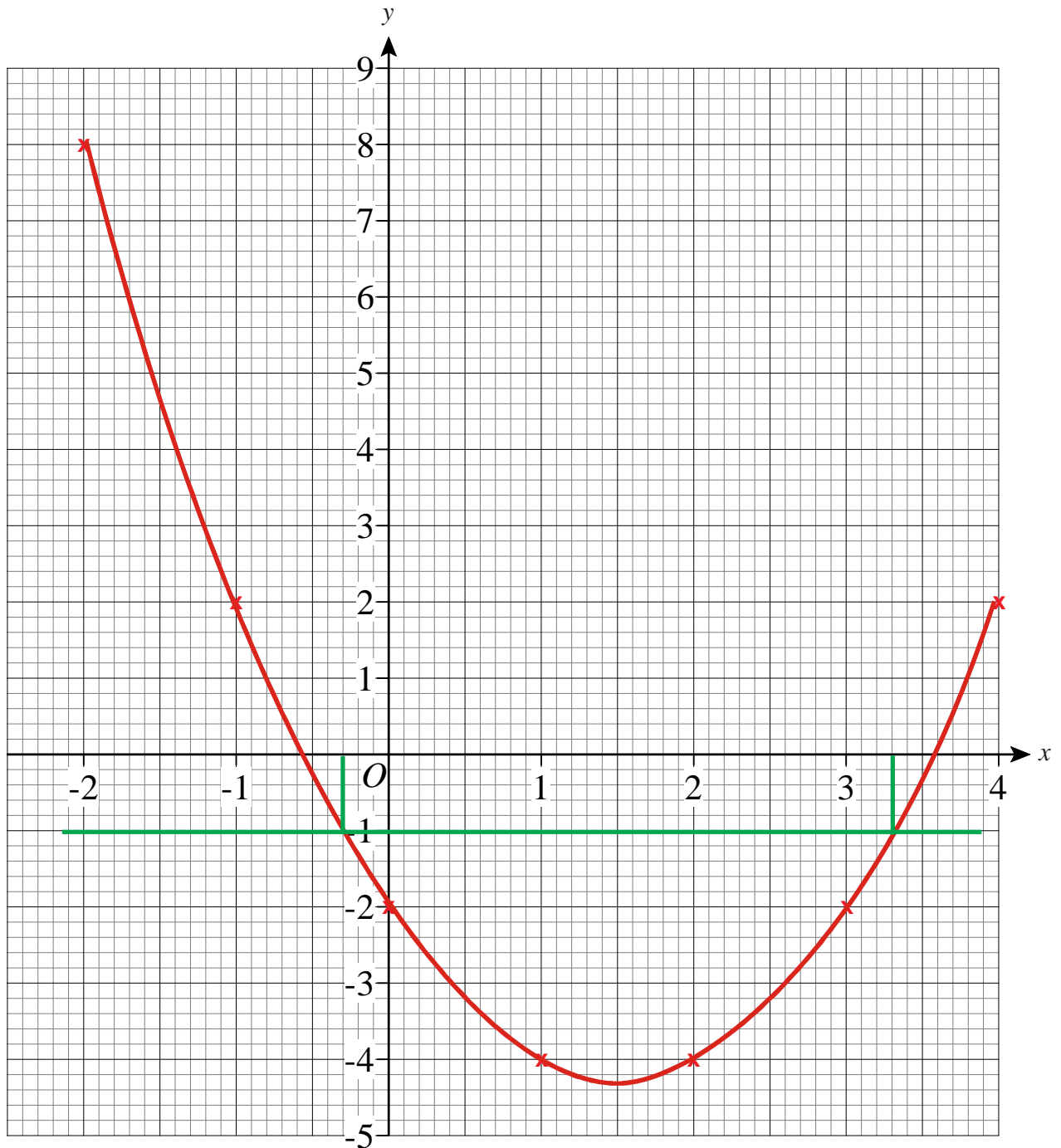

c) Use your graph to estimate the values of  $x$  when  $y = -1$   $x = -0.3$  and  $x = 3.3$



1) a) Complete the table of values for  $y = x^2 + x - 4$

x	-4	-3	-2	-1	0	1	2	3
y	8	2	-2	-4	-4	-2	2	8

b) On the grid, draw the graph of  $y = x^2 + x - 4$

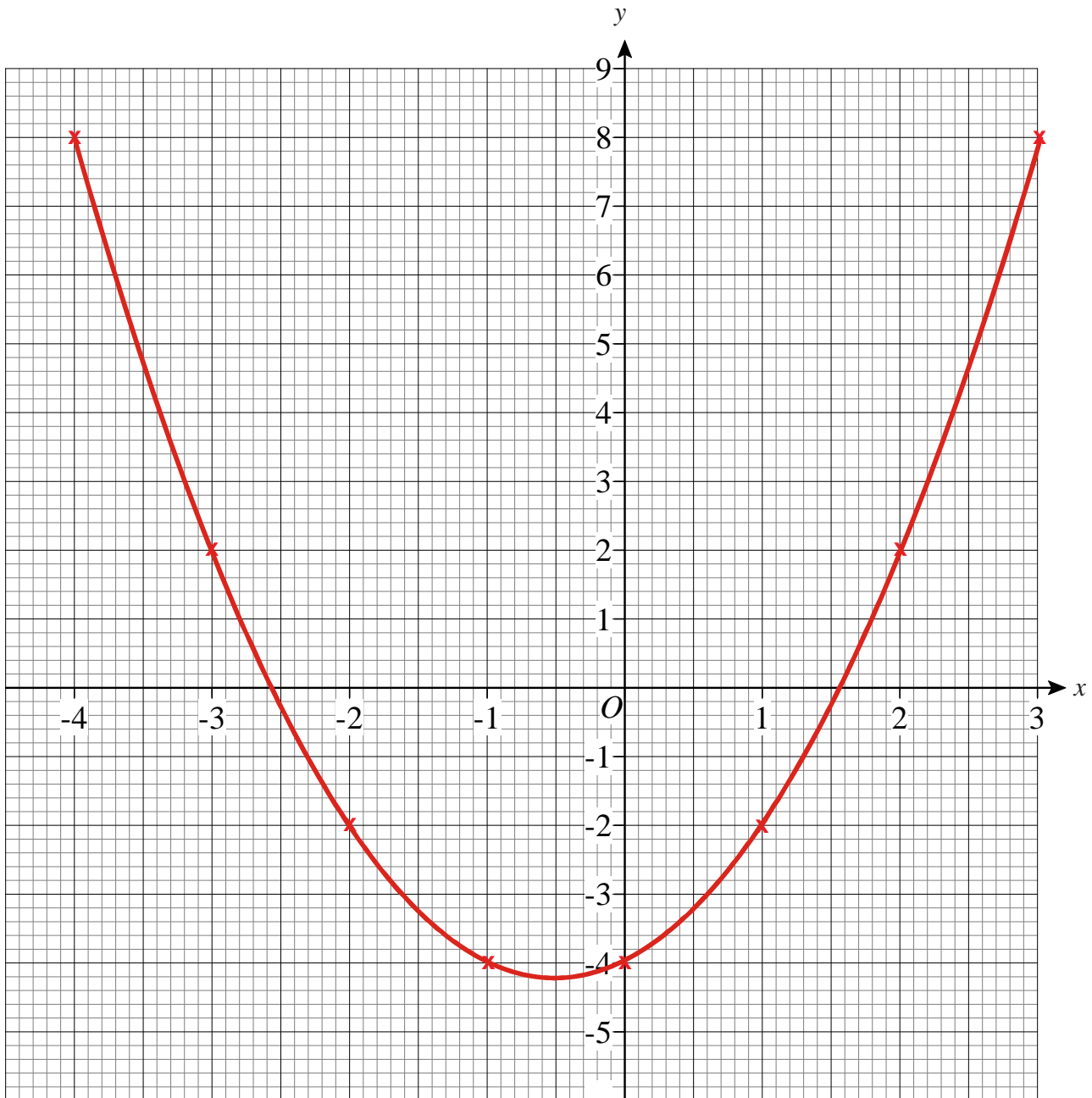



## Drawing Quadratic Graphs



- 1) a) Complete the table of values for  $y = 2x^2 - 3x$

$x$	-2	-1	0	1	2	3
$y$	14	5	0	-1	2	9

- b) On the grid, draw the graph of  $y = 2x^2 - 3x$  for values of  $x$  from -2 to 3

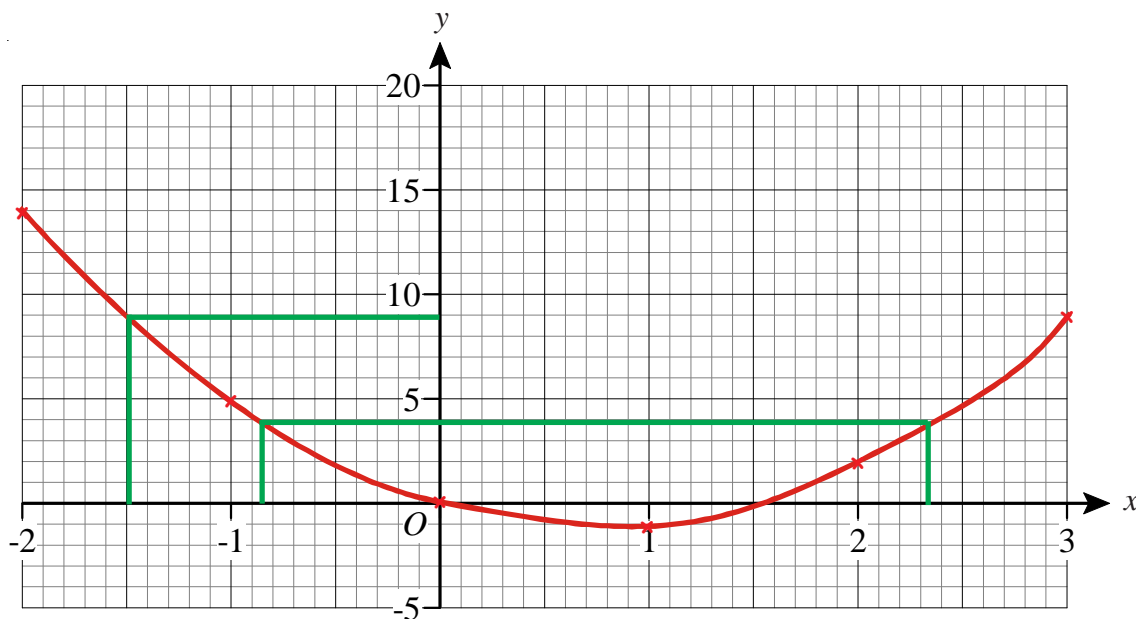

- c) Use the graph to find the value of  $y$  when  $x = -1.5$        $y = 9$   
 d) Use the graph to find the values of  $x$  when  $y = 4$        $x = -0.85$  and  $x = 2.33$



- 2) a) Complete the table of values for  $y = x^2 - 2x$

$x$	-2	-1	0	1	2	3
$y$	8	3	0	-1	0	3

- b) On the grid, draw the graph of  $y = x^2 - 2x$  for values of  $x$  from -2 to 3

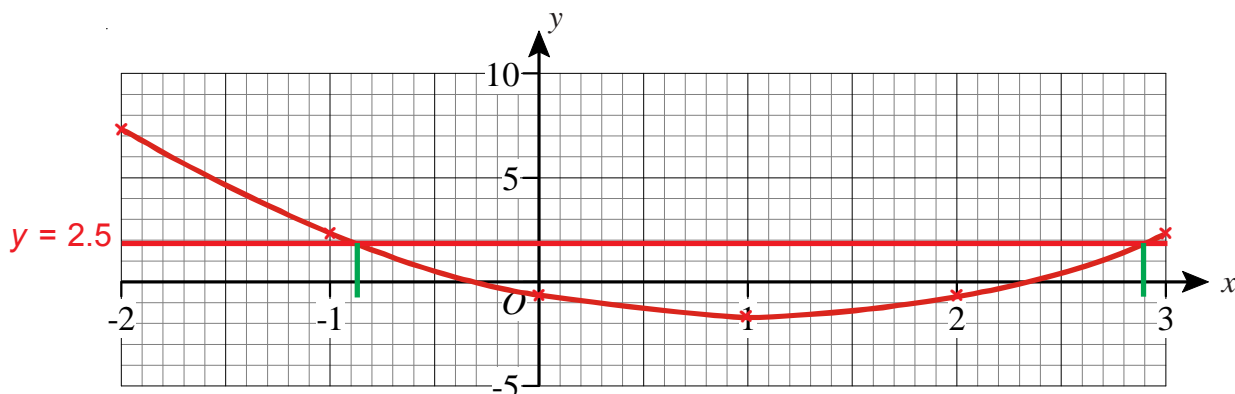

- c) (i) On the same axes draw the straight line  $y = 2.5$   
 (ii) Write down the values of  $x$  for which  $x^2 - 2x = 2.5$        $x = -0.89$  or  $x = 2.9$

1) The diagram shows the graph of  $y = x^2 - 5x - 3$

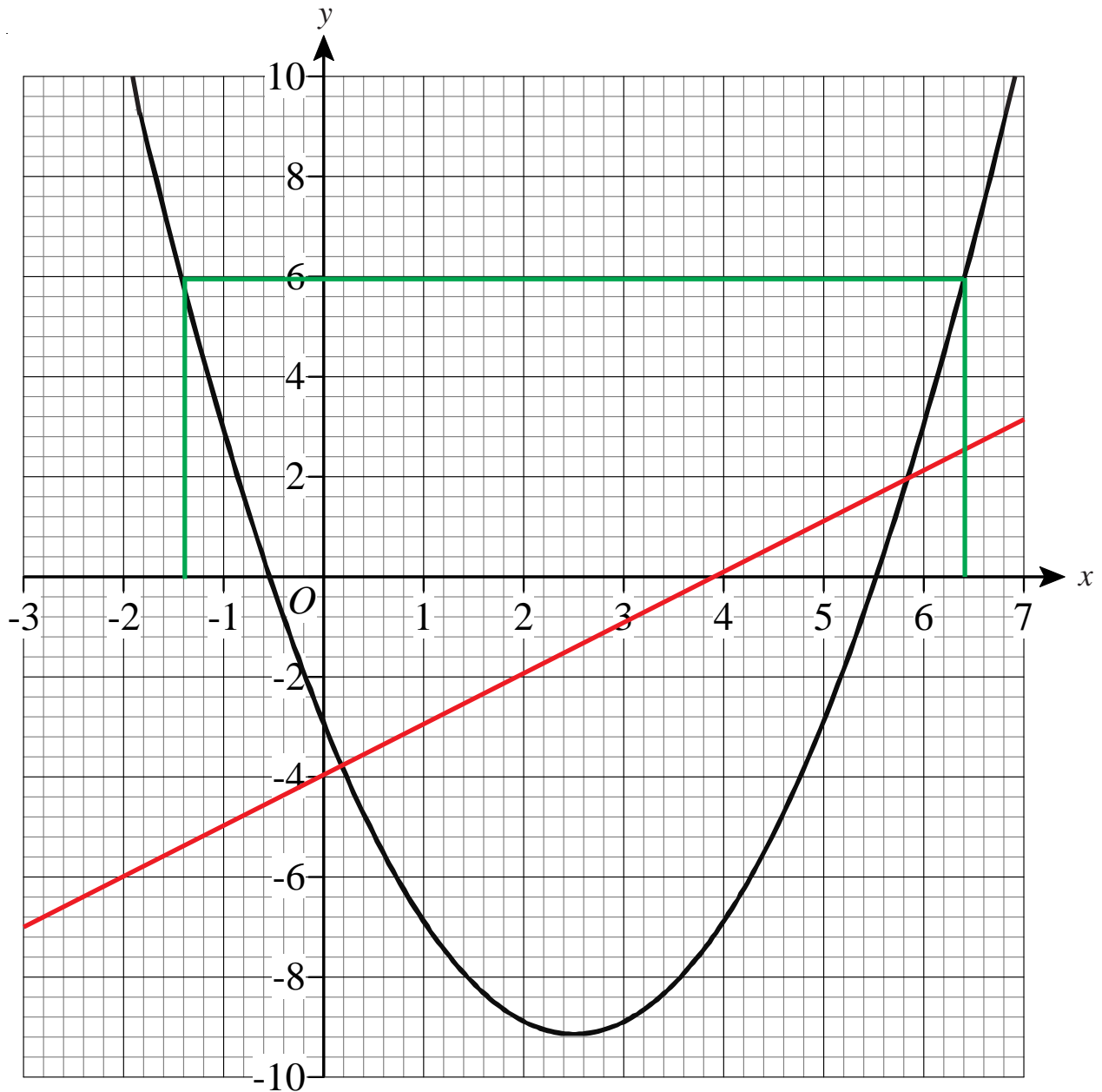

a) Use the graph to find estimates for the solutions of

(i)  $x^2 - 5x - 3 = 0$   $x = -0.5$  and  $5.5$

(ii)  $x^2 - 5x - 3 = 6$   $x = -1.4$  and  $6.4$

b) Use the graph to find estimates for the solutions of the simultaneous equations

$$\begin{array}{lll} y = x^2 - 5x - 3 & x = 0.2 & x = 5.8 \\ y = x - 4 & y = -3.8 & y = 1.8 \end{array}$$

# Sketching Functions

- 1) a) Sketch the graph of  $y = 3x - 4$  on the axes, showing clearly where it crosses the  $y$ -axis.
- b) Sketch the graph of  $y = -2x + 3$  on the axes, showing clearly where it crosses the  $y$ -axis.

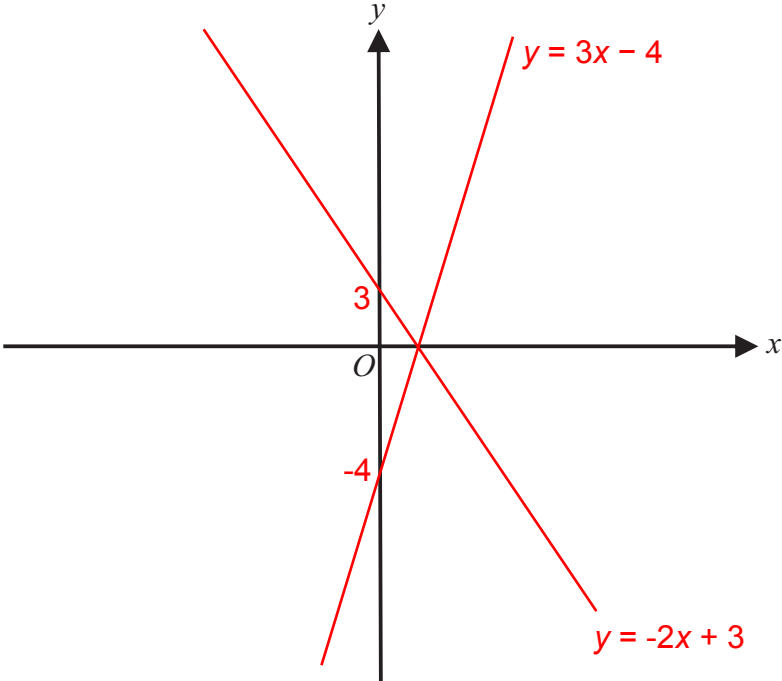

- 2) a) Sketch the graph of  $y = x^2 + 2$  on the axes, showing clearly where it crosses the  $y$ -axis.
- b) Sketch the graph of  $y = -x^2 - 1$  on the axes, showing clearly where it crosses the  $y$ -axis.

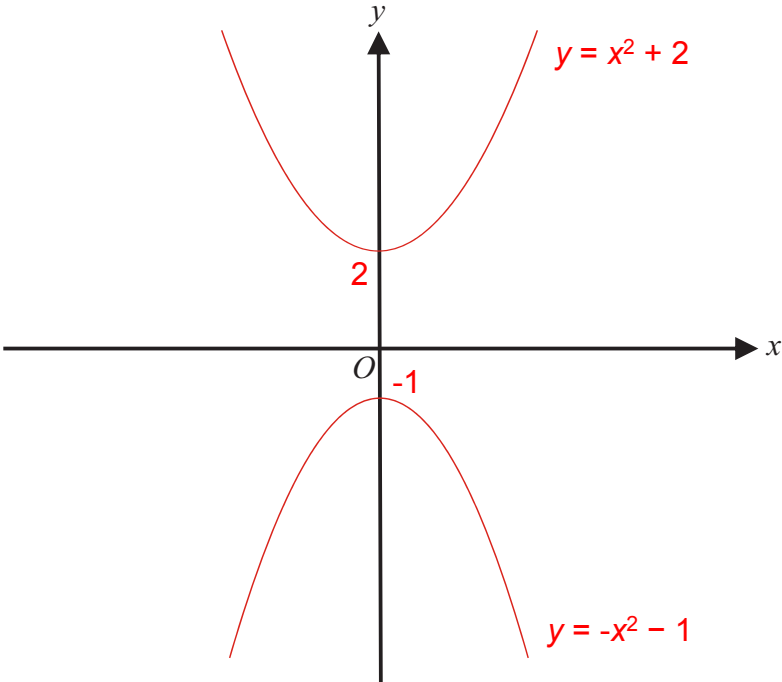

1) Solve the following equations.

a)  $2x - 7 = 11$

$x = 9$

b)  $5x + 3 = 43$

$x = 8$

2) Solve the following equations.

a)  $\frac{x}{5} + 1 = 7$

$x = 30$

b)  $\frac{x}{2} - 6 = 2.5$

$x = 17$

3) Solve the following equations.

a)  $2(4x - 1) = 46$

$x = 6$

b)  $6(2x + 7) = 48$

$x = 0.5$

4) Solve the following equations.

a)  $3\left(\frac{x}{7} + 2\right) = 6$

$x = 0$

b)  $2\left(\frac{5x}{3} - 1\right) = 8$

$x = 3$

- 1) Make  $x$  the subject of the formula  $w = 5x + 2$

$$x = \frac{w - 2}{5}$$

- 2) Make  $x$  the subject of the formula  $y = 2x - 6$

$$x = \frac{y + 6}{2}$$

- 3) Make  $x$  the subject of the formula  $2w = 3y + \frac{x}{5}$

$$x = 5(2w - 3y)$$

- 4) Make  $t$  the subject of the formula  $a = 2(b + 3t) + 1$

$$t = \frac{\frac{a - 1}{2} + b}{3}$$

- 5) Make  $x$  the subject of the formula  $y = 5 + \sqrt{x}$

$$x = (y - 5)^2$$

- 6) Make  $t$  the subject of the formula  $w = x^2 + t$

$$t = w - x^2$$

- 7) Make  $n$  the subject of the formula  $m = 3n^2 - p$

$$n = \sqrt{\frac{m + p}{3}}$$

- 8) Make  $q$  the subject of the formula  $2(5q^2 + 1) = c$

$$q = \sqrt{\frac{\frac{c}{2} - 1}{5}}$$

- 1) The  $n$ th term of a number sequence is  $2n + 5$   
Write down the first three terms of the sequence.  
**7, 9, 11**
- 2) The  $n$ th term of a number sequence is  $3n - 1$   
Write down the first four terms of the sequence.  
**2, 5, 8, 11**
- 3) The  $n$ th term of a number sequence is  $3n + 2$   
Write down the first four terms of the sequence.  
**5, 8, 11, 14**
- 4) The  $n$ th term of a number sequence is  $5n - 7$   
Write down the first four terms of the sequence.  
**-2, 3, 8, 13**
- 5) The  $n$ th term of a number sequence is  $n^2$   
Write down the first three terms of the sequence.  
**1, 4, 9**
- 6) The  $n$ th term of a number sequence is  $n^2 + 3$   
Write down the first three terms of the sequence.  
**4, 7, 12**
- 7) The  $n$ th term of a number sequence is  $11 - n^2$ 
  - a) Find the third term of this sequence. **2**
  - b) Find the fifth term of this sequence. **-14**
- 8) The  $n$ th term of a number sequence is  $n^2 + n$ 
  - a) Find the third term of this sequence. **12**
  - b) Find the fifth term of this sequence. **30**

- 1) Here are the first five terms of an arithmetic sequence.

1      3      5      7      9

Find, in terms of  $n$ , an expression for the  $n$ th term of this sequence.

$$2n - 1$$

- 2) Here are the first five terms of an arithmetic sequence.

6      10      14      18      22

Find, in terms of  $n$ , an expression for the  $n$ th term of this sequence.

$$4n + 2$$

- 3) Here are the first five terms of an arithmetic sequence.

1      4      7      10      13

Find, in terms of  $n$ , an expression for the  $n$ th term of this sequence.

$$3n - 2$$

- 4) Here are the first five terms of an arithmetic sequence.

7      12      17      22      27

Find, in terms of  $n$ , an expression for the  $n$ th term of this sequence.

$$5n + 2$$

- 5) Here are the first five terms of an arithmetic sequence.

8      6      4      2      0

Find, in terms of  $n$ , an expression for the  $n$ th term of this sequence.

$$-2n + 10$$

- 1) Here are the first four terms of an arithmetic sequence.

4    7    10    13

Find an expression, in terms of  $n$ , for the  $n$ th term of the sequence.

$3n + 1$

- 2) The  $n$ th term of a number sequence is  $n^2 + 3$   
Write down the first three terms of the sequence.

4, 7, 12

- 3) Here are the first five terms of an arithmetic sequence.

2    7    12    17    22

- a) Find, in terms of  $n$ , an expression for the  $n$ th term of this sequence.  $5n - 3$
- b) An expression for the  $n$ th term of another sequence is  $11 - n^2$
- (i) Find the third term of this sequence.  $2$
- (ii) Find the fifth term of this sequence.  $-14$

- 4) The  $n$ th term of a sequence is  $2n^2$

- (i) Find the 4th term of the sequence.  $32$
- (ii) Is the number 400 a term of the sequence?

Give reasons for your answer.  $\text{No, } 400 = 2 \times 200, \text{ but } 200 \text{ is not a square number.}$



- 1) The  $n$ th term of a number sequence is given by  $4n + 1$   
 a) Work out the first **two** terms of the number sequence.

**5, 9**

Here are the first four terms of another number sequence.

1 4 7 10

- b) Find, in terms of  $n$ , an expression for the  $n$ th term of this number sequence.

**$3n - 2$**

- 2) Here is a number pattern.

Line Number			
<b>1</b>	$1^2 + 3^2$	$2 \times 2^2 + 2$	10
<b>2</b>	$2^2 + 4^2$	$2 \times 3^2 + 2$	20
<b>3</b>	$3^2 + 5^2$	$2 \times 4^2 + 2$	34
<b>4</b>	<b><math>4^2 + 6^2</math></b>	<b><math>2 \times 5^2 + 2</math></b>	<b>52</b>
⋮			
<b>10</b>	<b><math>10^2 + 12^2</math></b>	<b><math>2 \times 11^2 + 2</math></b>	<b>244</b>

- a) Complete Line Number 4 of the pattern.  
 b) Complete Line Number 10 of the pattern.  
 c) Use the number pattern to find the answer to  $999^2 + 1001^2$  **2000002**

- 1) What is the term to term rule for each sequence, below?
- a) 1, 4, 16, 64, 256 **Multiply by 4**
  - b) 6, 12, 24, 48, 96 **Multiply by 2**
  - c) 80, 40, 20, 10, 5 **Divide by 2**
  - d) 48, 12, 3, 0.75, 0.1875 **Divide by 4**
- 2) a) What is the special name for this sequence?
- 1, 4, 9, 16, 25 **Square numbers**
- b) What would be the 10th term of the sequence? **100**
  - c) What is the  $n$ th term of the sequence?  **$n^2$**
- 3) By comparing the following sequences with the sequence of square numbers, find the  $n$ th term for each one.
- a) 4, 7, 12, 19, 28  **$n^2 + 3$**
  - b) -1, 2, 7, 14, 23  **$n^2 - 2$**
  - c) 3, 12, 27, 48, 75  **$3n^2$**
- 4) a) What is the special name for this sequence?
- 1, 3, 6, 10, 15 **Triangular numbers**
- b) What would be the 8th term of the sequence? **36**
  - c) What is the  $n$ th term of the sequence?  **$\frac{n(n+1)}{2}$**
  - d) Use the  $n$ th term to work out the 21st term of the sequence. **231**

## Exchanging Money



- 1) Lance goes on holiday to France.  
The exchange rate is £1 = 1.15 Euros.

He changes £350 into Euros.

- a) How many Euros should he get? **€402.50**

In France, Lance buys a digital camera for 115 Euros.

- b) Work out the cost of the camera in pounds. **£100**



- 2) Whilst on holiday in Spain, Gemma bought a pair of sunglasses for 77 Euros.  
In England, an identical pair of sunglasses costs £59.99.  
The exchange rate is £1 = 1.40 Euros.

In which country were the glasses the cheapest, and by how much?

Show all your working. **Spain, by £4.99**

$$77 \div 1.40 = 55 \quad 59.99 - 55.00 = 4.99$$



- 3) Luke buys a pair of trainers in Switzerland.  
He can pay either 86 Swiss Francs or 56 Euros.

The exchange rates are:

$$£1 = 2.10 \text{ Swiss Francs}$$

$$£1 = 1.40 \text{ Euros}$$

Which currency should he choose to get the best price, and how much would he save?

Give your answer in pounds (£). **Euros, saving £0.95**



- 4) The exchange rate in London is £1 = €1.14  
The exchange rate in Paris is €1 = £0.86

Tony wants to change some pounds into euros.

In which of these cities would Tony get the most euros?

All working must be shown. **Paris**

eg Suppose Tony changes £100.

In London he would get  $100 \times 1.14 = €114$

In Paris he would get  $100 \div 0.86 = €116.28$

- 1) Tom and Julie share £48 in the ratio 5 : 3  
Work out how much more money Tom gets than Julie gets. **£12**
- 2) Ben and Sue share £60 in the ratio 2 : 3  
Work out how much each person gets. **Ben gets £24 and Sue gets £36**
- 3) A box contains milk chocolates and plain chocolates only.  
The number of milk chocolates to the number of plain chocolates is in the ratio 2 : 1  
There are 24 milk chocolates.  
Work out the total number of chocolates. **36 chocolates altogether**
- 4) Andy, Ben and Claire share £54  
Ben gets three times as much money as Andy.  
Claire gets twice as much money as Ben.

How much money does Claire get? **£32.40**



- 5) There are some marbles in a bag.  
18 of the marbles are blue.  
12 of the marbles are red.
- a) Write down the ratio of the number of blue marbles to the number of red marbles.  
Give your ratio in its simplest form. **3 : 2**

There are some apples and pears in a box.  
The total number of apples and pears is 54.  
The ratio of the number of apples to the number of pears is 1 : 5

- b) Work out the number of pears in the box. **45 pears**



- 6) A piece of string is 180 cm long.  
Jim cuts it into three pieces in the ratio 2 : 3 : 4  
Work out the length of the longest piece. **80 cm**



- 7) Sally is 13 years old.  
Tammy is 12 years old.  
Danny is 10 years old.
- Sally, Tammy and Danny share £28 in the ratio of their ages.  
Tammy gives a third of her share to her mother.  
How much should Tammy now have? **£6.40**

- 1) In a box of chocolates, the ratio of plain chocolates to milk chocolates is 2 : 5.
- What fraction of the chocolates are plain ones?  $\frac{2}{7}$
  - What fraction of the chocolates are milk ones?  $\frac{5}{7}$
- 2) If the ratio of  $x : y$  is 3 : 7, which of the following statements are correct? **b and d**
- $x$  is  $\frac{3}{7}$  of  $(x + y)$
  - $x$  is  $\frac{3}{10}$  of  $(x + y)$
  - $y$  is  $\frac{7}{10}$  of  $x$
  - $y$  is  $\frac{7}{10}$  of  $(x + y)$
- 3) Pounds can be converted to kilograms using the ratio 11 : 5.
- Use the squares, below, to draw a conversion graph to illustrate this.
  - Convert 24 pounds to kilograms. **11 kg**
  - Convert 14 kilograms to pounds. **30.8 lb**

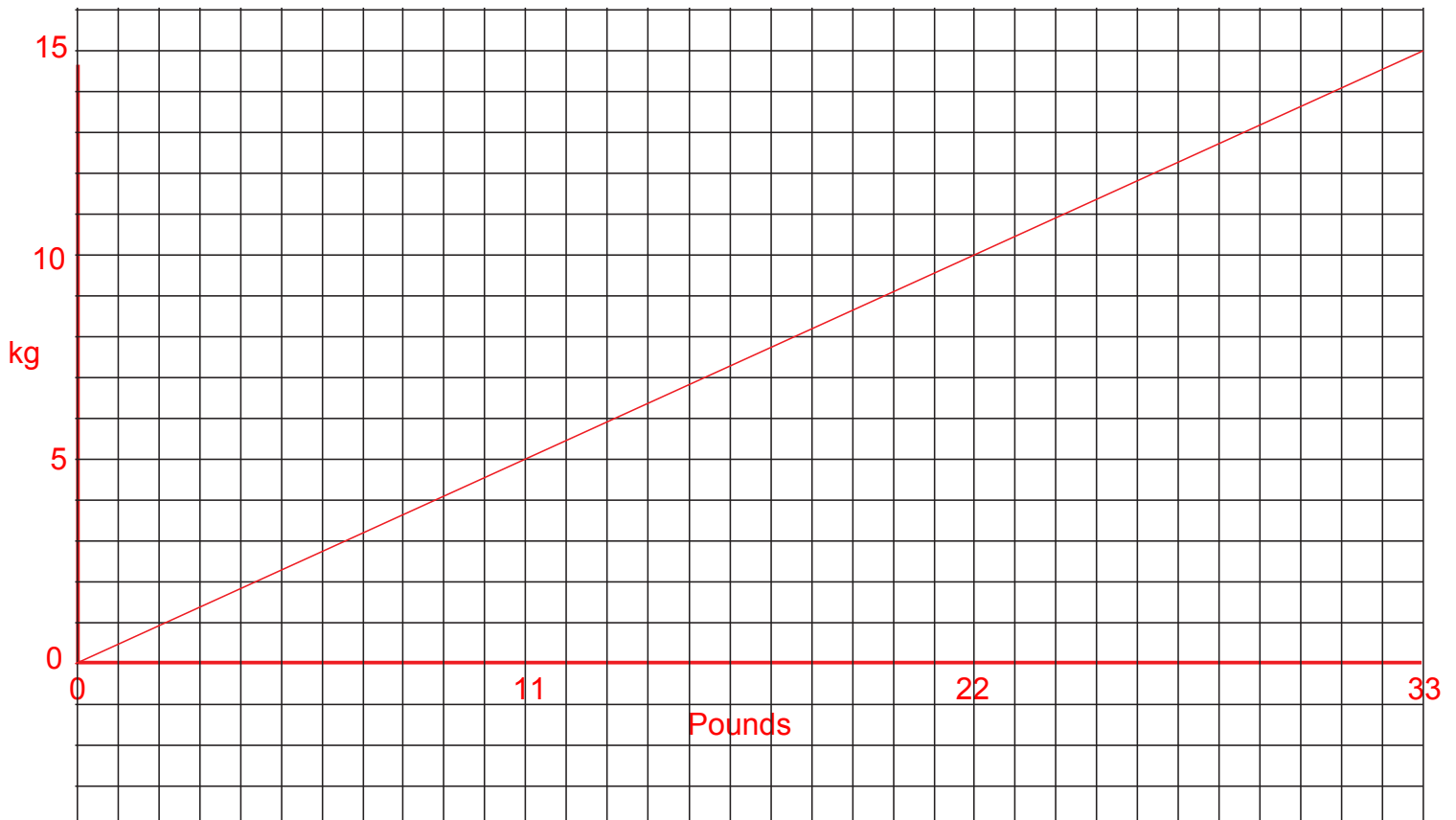

## Increase/Decrease by a Percentage

1) Increase:

a) 500 by 10%  
**550**b) 320 by 10%  
**352**c) 80 by 15%  
**92**d) 75 by 20%  
**90**

2) Decrease:

a) 400 by 10%  
**360**b) 380 by 10%  
**342**c) 140 by 15%  
**119**d) 35 by 20%  
**28**

3) The price of a laptop is increased by 15%.

The old price of the laptop was £300.

Work out the new price. **£345**

4) The price of a £6800 car is reduced by 10%.

What is the new price? **£6120**

5) Increase:

a) 65 by 12% **72.8**b) 120 by 23% **147.6**c) 600 by 17.5% **705**d) 370 by 17.5% **434.75**

6) Decrease:

a) 42 by 15% **35.7**b) 79 by 12% **69.52**c) 52 by 8.5% **47.58**d) 8900 by 18% **7 298**

7) The price of a mobile phone is £78.40 plus VAT.

VAT is charged at a rate of 17.5%.

What is the total price of the mobile phone? **£92.12**

8) In a sale, normal prices are reduced by 7%.

The normal price of a camera is £89.

Work out the sale price of the camera. **£82.77**

9) A car dealer offers a discount of 20% off the normal price of a car, for cash.

Peter intends to buy a car which usually costs £6800.

He intends to pay by cash.

Work out how much he will pay. **£5440**

10) A month ago, John weighed 97.5 kg.

He now weighs 4.5% more.

Work out how much John now weighs. **101.9 kg**

Give your answer to 1 decimal place.



- 1) A car dealer is comparing his sales over the past two years.

In 2006, he sold 175 cars.

In 2007, he sold 196 cars.

Work out the percentage increase in the number of cars sold. **12%**



- 2) In September 2005, the number of pupils attending MathsWatch College was 1352.

In September 2006, the number of pupils attending MathsWatch College was 1014.

Work out the percentage decrease in the number of pupils attending MathsWatch College. **25%**



- 3) The usual price of a shirt is £32.50

In a sale, the shirt is reduced to £29.25

What is the percentage reduction? **10%**



- 4) Olivia opened an account with £750 at the MathsWatch Bank.

After one year, the bank paid her interest.

She then had £795 in her account.

Work out, as a percentage, MathsWatch Bank's interest rate. **6%**



- 5) Keith buys a house for £270 000 and sells it two years later for £300 000.

What is his percentage profit?

Give your answer to 2 significant figures. **11%**



- 6) Shelley bought some items at a car boot sale and then sold them on ebay.

Work out the percentage profit or loss she made on each of these items.

a) Trainers bought for £15, sold for £20 **33.3% profit**

b) DVD recorder bought for £42, sold for £60.90 **45% profit**

c) Gold necklace bought for £90, sold for £78.30 **13% loss**

d) A DVD collection bought for £120, sold for £81.60 **32% loss**

## Reverse Percentage Problems



- 1) In a sale, normal prices are reduced by 20%.

The sale price of a shirt is £26

Calculate the normal price of the shirt. **£32.50**



- 2) A car dealer offers a discount of 15% off the normal price of a car for cash.

Emma pays £6120 cash for a car.

Calculate the normal price of the car. **£7200**



- 3) In a sale, normal prices are reduced by 13%.

The sale price of a DVD recorder is £108.75

Calculate the normal price of the DVD recorder. **£125**



- 4) A salesman gets a basic wage of £160 per week plus a commission of 30% of the sales he makes that week.

In one week his total wage was £640

Work out the value of the sales he made that week. **£1600**



- 5) Jason opened an account at MathsWatch Bank.

MathsWatch Bank's interest rate was 4%.

After one year, the bank paid him interest.

The total amount in his account was then £1976

Work out the amount with which Jason opened his account. **£1900**



- 6) Jonathan's weekly pay this year is £960.

This is 20% more than his weekly pay last year.

Tess says "This means Jonathan's weekly pay last year was £768".

Tess is wrong.

a) Explain why **Tess has calculated 20% of £960, and subtracted it.**

b) Work out Jonathan's weekly pay last year. **£800**



- 7) The price of all rail season tickets to London increased by 4%.

a) The price of a rail season ticket from Oxford to London increased by £122.40

Work out the price before this increase. **£3060**

b) After the increase, the price of a rail season ticket from Newport to London was £2932.80

Work out the price before this increase. **£2820**



- 1) Meg has £1200 in her savings account.  
The account pays 5% simple interest per year.

How much interest will she earn in 4 years?

**£240**

- 2) Dan has £4000 in his savings account.  
This account pays 2% interest per year.

How much interest will he earn in 6 years?

**£480**

- 3) Chris borrows £6000 at a simple interest rate of 10% per year.  
He pays the money back after 4 years.

How much does he pay back in total?

**£8400**

- 4) Lisa borrows £3000 at a simple interest rate of 2.5% per year.  
She pays the money back after 3 years.

How much does she pay back in total?

**£3225**

- 5) Kate borrows £2000 at a simple interest rate of 16% per year.  
She pays the money back after 3 months.

How much does she pay back in total?

**£2080**

- 6) Neil invested £8000 in a savings account for 2 years.  
He earned £640 simple interest over the two years.

What was the interest rate?

**4%**

## Metric Conversions

- 1) Change  $9 \text{ m}^2$  into  $\text{cm}^2$      **$90000 \text{ cm}^2$**
- 2) How many square metres are there in 5 square kilometres?     **$5000000 \text{ m}^2$**
- 3) Change  $4 \text{ cm}^2$  into  $\text{mm}^2$      **$400 \text{ mm}^2$**
- 4) Convert  $6.5 \text{ m}^2$  into  $\text{mm}^2$      **$6500000 \text{ mm}^2$**
- 5) Change  $2 \text{ m}^3$  into  $\text{cm}^3$      **$2000000 \text{ cm}^3$**
- 6) How many cubic millimetres are there in 3 cubic centimetres?     **$3000 \text{ mm}^3$**
- 7) Change  $7 \text{ m}^3$  into  $\text{mm}^3$      **$7000000000 \text{ mm}^3$**
- 8) A tiler wants to tile a rectangular wall which measures 4 m by 2.5 m.  
Each tile measures 16 cm by 10 cm.  
How many tiles will he need for the wall?    **625**

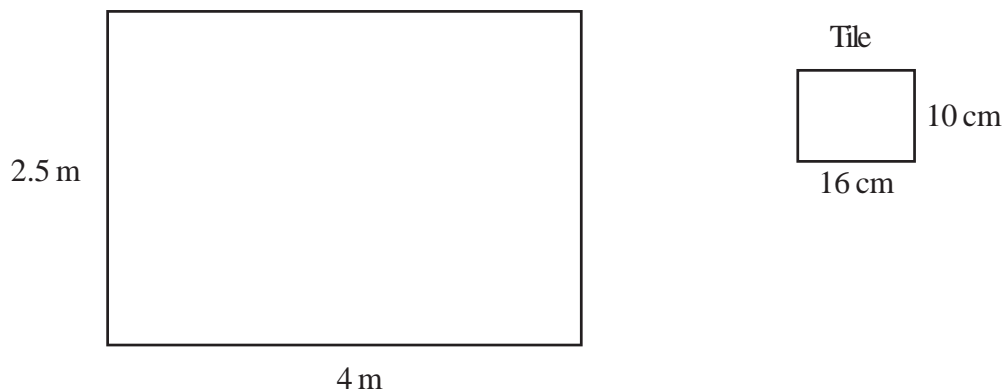

- 9) A carpet-fitter is laying carpet tiles on a rectangular floor which measures 7.5 m by 4.5 m.  
Each carpet tile measures 50 cm by 50 cm.  
How many carpet tiles will he need for the floor?    **135**

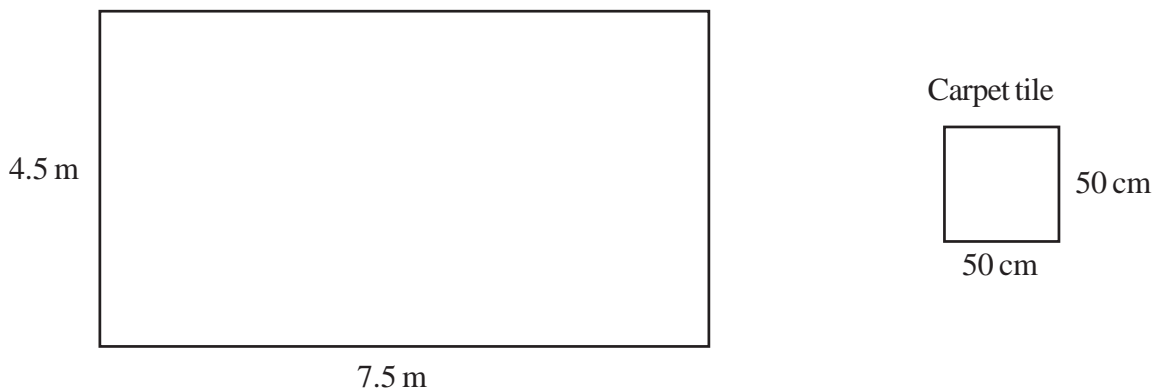

- 1) The points  $A(3, 0)$ ,  $B(2, 4)$  and  $C(-3, 1)$  are three corners of a parallelogram.

What are the coordinates of the 4th corner?  $(-2, -3)$

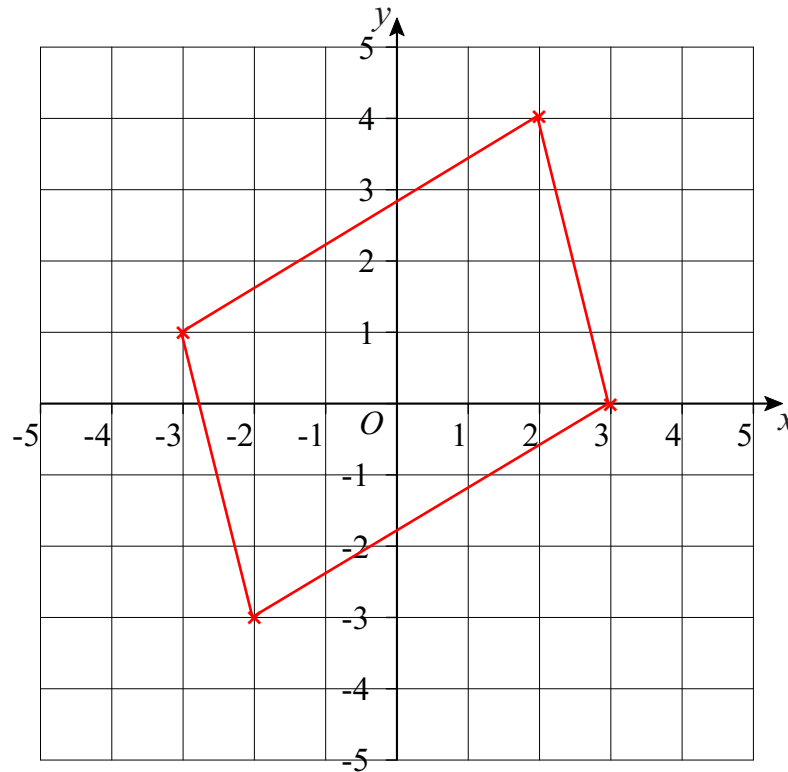

- 2) The diagram shows 3 vertices of a parallelogram.

Write down the coordinates of all the possibilities for the 4th vertex.  $(-1, -1)$  or  $(-3, 3)$  or  $(5, 1)$

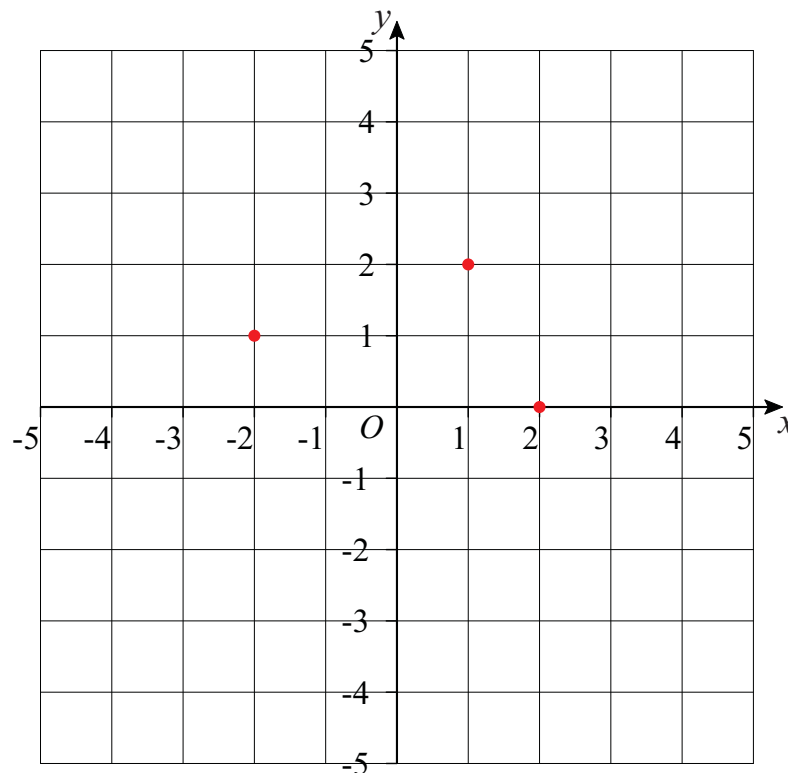

## Surface Area of a Prism - Cuboids

- 1) A cube has sides of length 5 cm.

Find the total surface area of the cube. **150 cm<sup>2</sup>**

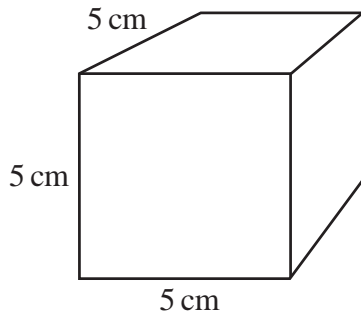

- 2) A cuboid has sides of length 10 cm, 6 cm and 7 cm.

Find the total surface area of the cuboid. **344 cm<sup>2</sup>**

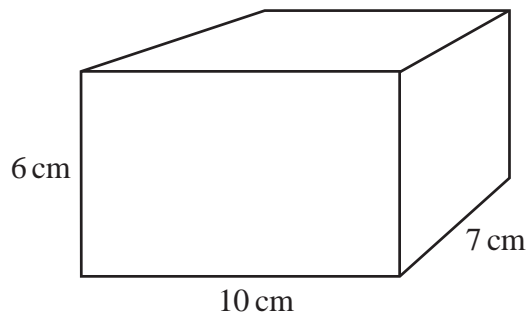

- 3) A cuboid has sides of length 12 cm, 4.5 cm and 6 cm.

Find the total surface area of the cuboid. **306 cm<sup>2</sup>**

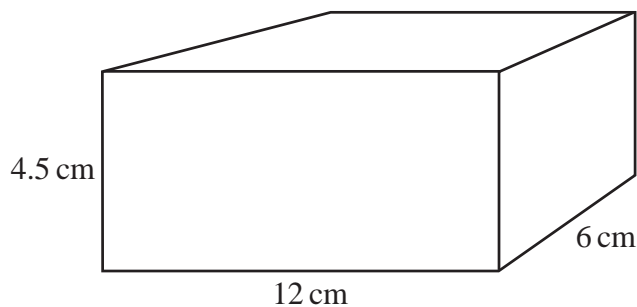

## Surface Area of a Prism - Triangular Prisms

- 1) Find the surface area of this triangular prism. **84 cm<sup>2</sup>**

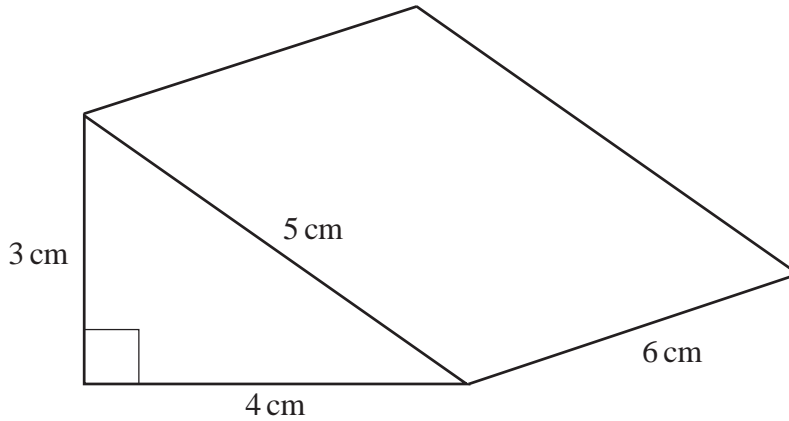

- 2) Find the surface area of this triangular prism. **660 cm<sup>2</sup>**

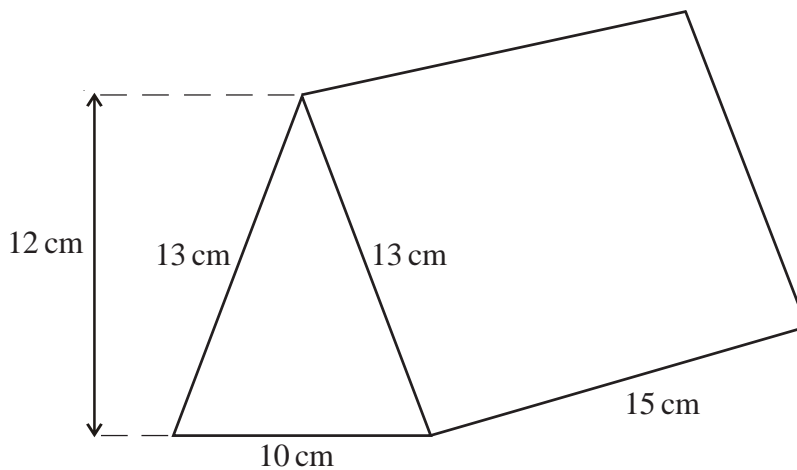

- 3) With the aid of Pythagoras' Theorem, find the surface area of this triangular prism. Give your answer correct to 2 significant figures. **120 cm<sup>2</sup>**

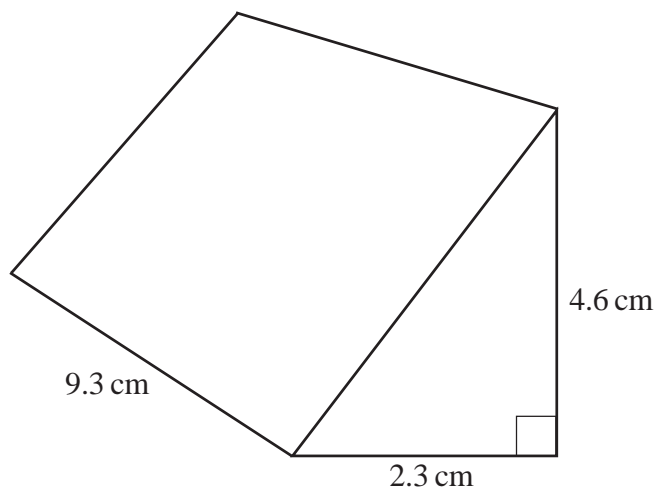

## Volume of a Cuboid

- 1) Find the volume of this cuboid.  $300 \text{ cm}^3$

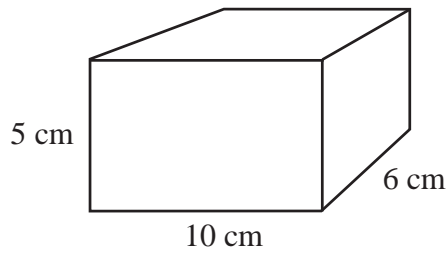

- 2) Find the volume of this cuboid.  $3.128 \text{ m}^3$

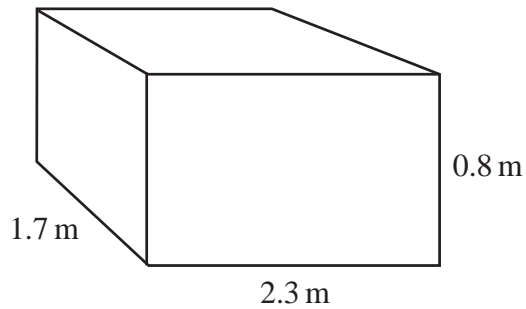

- 3) The volume of this cuboid is  $480 \text{ cm}^3$ .  
Find the length of the side marked  $x$ .  $10 \text{ cm}$

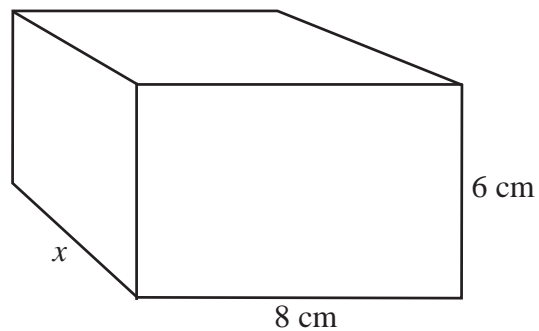

- 4) Boxes  $A$  and  $B$  are both cuboids.  
How many of box  $B$  could be packed into box  $A$ ?  $80$

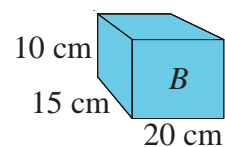
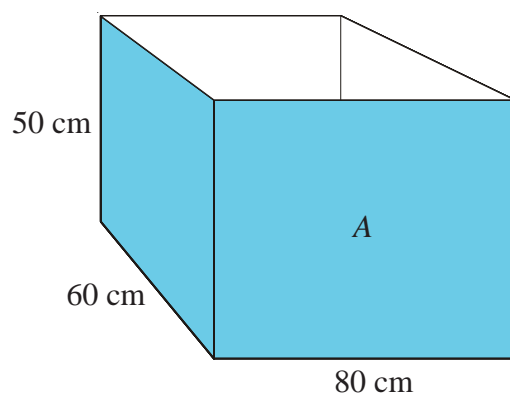

- 1) In the circle, write the correct names for line  $A$ ,  $B$  and  $C$ .

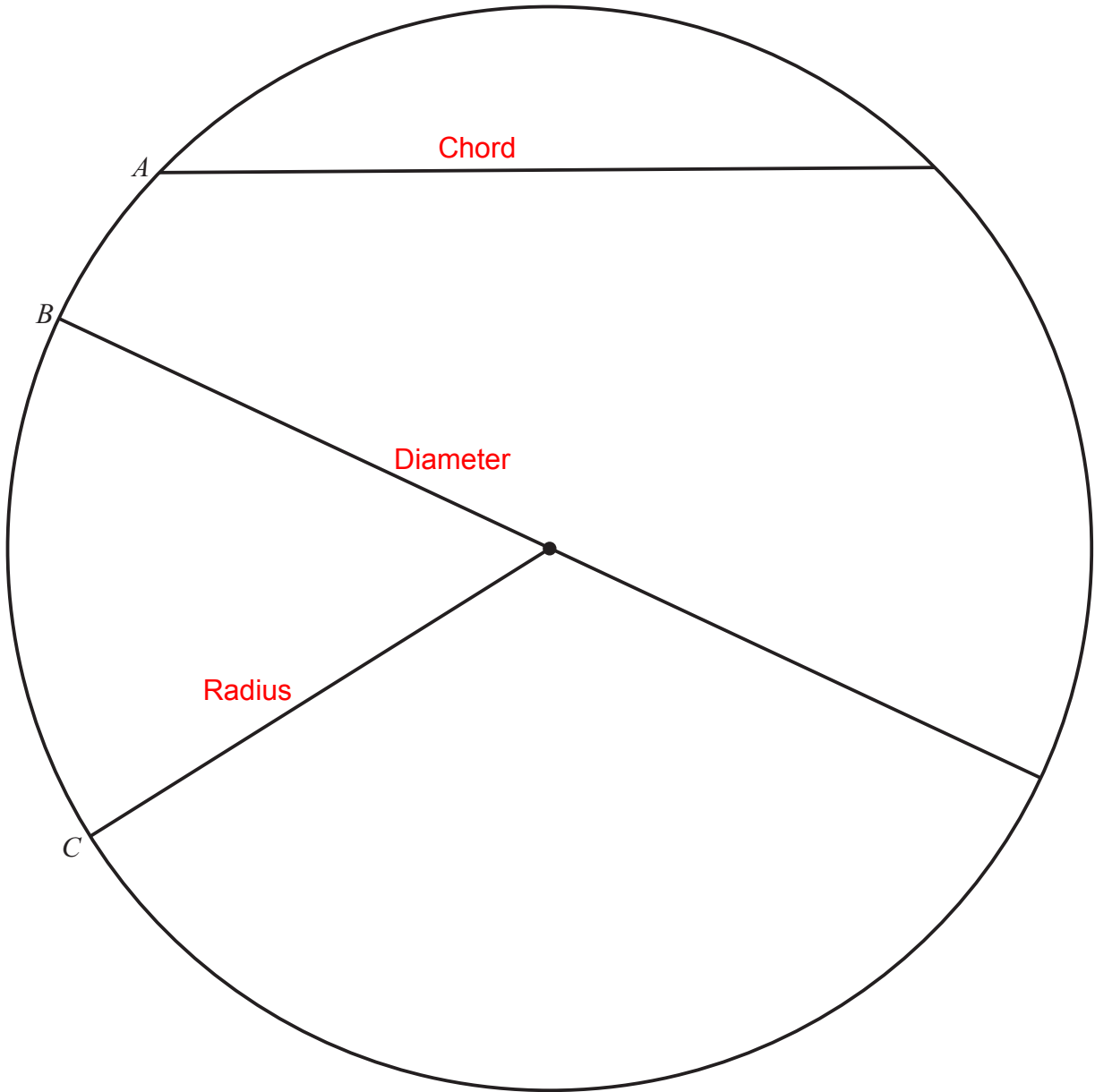

- 2) What is the special name given to the perimeter of a circle? **Circumference**



1) Find the areas of the following shapes.

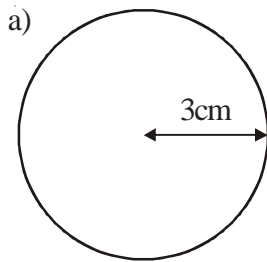

28.278 cm<sup>2</sup>

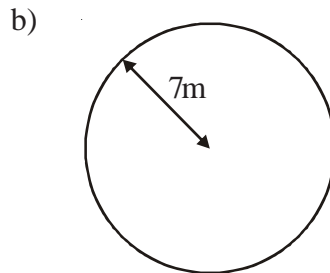

153.958 m<sup>2</sup>

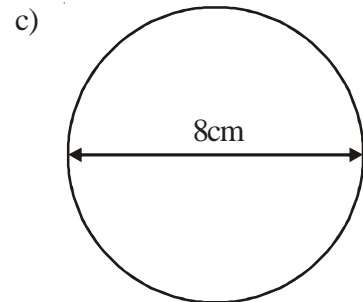

50.272 cm<sup>2</sup>



2) Work out the areas of the following shapes.

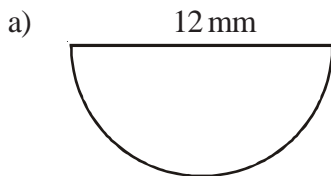

56.556 mm<sup>2</sup>

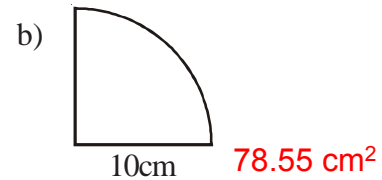

78.55 cm<sup>2</sup>



3) The **radius** of the top of a circular table is 60 cm.  
The table also has a circular base with **diameter** 30 cm.

a) Work out the area of the top of the table. 11311.2 cm<sup>2</sup>

b) Work out the area of the base of the table. 706.95 cm<sup>2</sup>



4) The diagram shows a shape, made from a semi-circle and a rectangle.  
The diameter of the semi-circle is 13 cm.  
The length of the rectangle is 17 cm.

Calculate the area of the shape.  
Give your answer correct to  
3 significant figures. 287 cm<sup>2</sup>

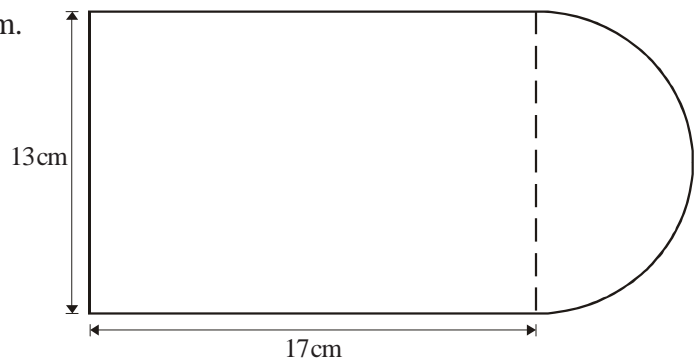





1) Find the circumference of the following shapes.

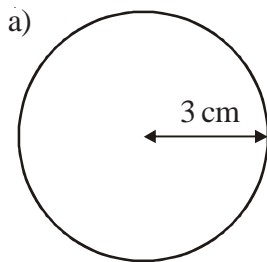

18.852 cm

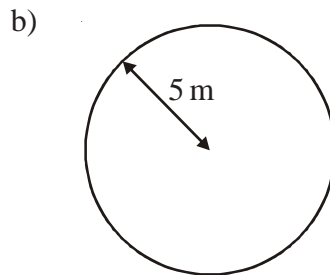

31.42 m

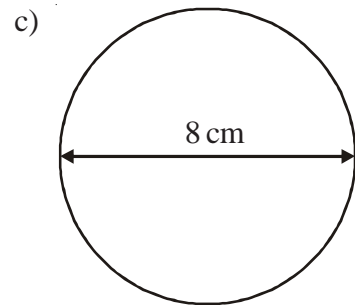

25.136 cm



2) Work out the perimeter of the following shapes.

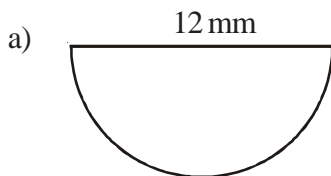

30.852 mm

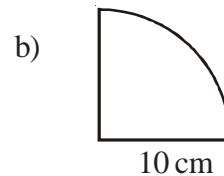

35.71 cm



3) The **radius** of the top of a circular table is 60 cm.  
The table also has a circular base with **diameter** 30 cm.

a) Work out the circumference of the top of the table.

Let  $\pi$  be 3.14 **376.8 cm**

b) Work out the circumference of the base of the table.

Let  $\pi$  be 3.14 **94.2 cm**



4) The diagram shows a shape, made from a semi-circle and a rectangle.  
The diameter of the semi-circle is 12 cm.  
The length of the rectangle is 15 cm.

Calculate the perimeter of the shape.

Give your answer correct to

3 significant figures. **60.9 cm**

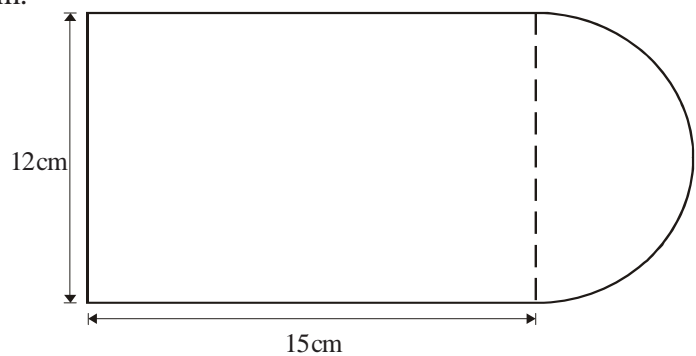

## Area and Circumference of a Circle

- 1) A circle has a radius of 5 cm.  
A square has sides of length 12 cm.

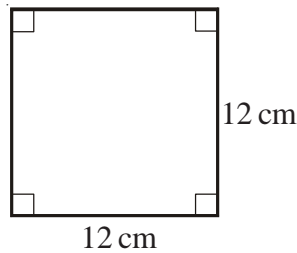
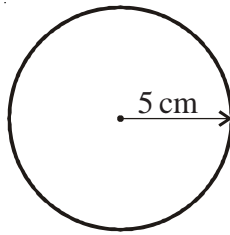

Work out the difference between the area of the circle and the area of the square if you take  $\pi$  to be 3.

**69 cm<sup>2</sup>**



- 2) Here is a tile in the shape of a semi-circle.

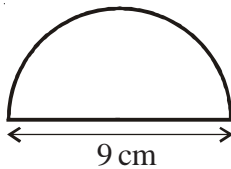

The diameter of the semi-circle is 9 cm.

Work out the perimeter of the tile.

Give your answer correct to two decimal places. **23.14 cm**



- 3) A circle has a radius of 7 cm.

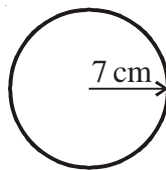

Work out the area of the circle.

Give your answer correct to three significant figures. **154 cm<sup>2</sup>**



- 4) A circle has a diameter of 14 cm.

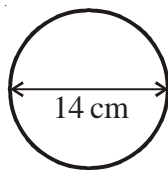

Work out the circumference of the circle.

Give your answer correct to three significant figures. **44.0 cm**



- 1) The radius of a circle is 10 cm.

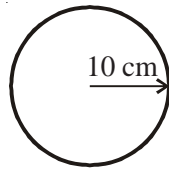

Work out the area of this circle. **314.2 cm<sup>2</sup>**



- 2) The diagram shows a circular pond with a path around it.

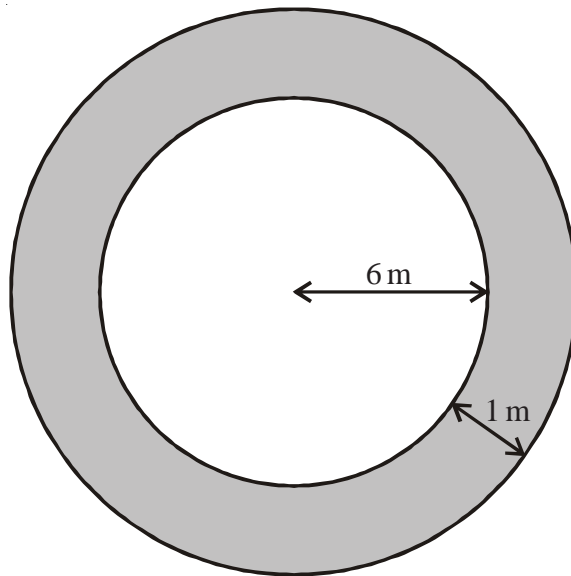

The pond has a radius of 6 m.

The path has a width of 1 m.

Work out the area of the path.

Give your answer correct to 3 significant figures. **40.8 m<sup>2</sup>**



- 3) The diagram shows a CD which has a radius of 6 cm.

a) Work out the circumference of the CD.

Give your answer correct to 3 significant figures.

**37.7 cm**

CDs of this size are cut from rectangular sheets of plastic.

Each sheet is 1 metre long and 50 cm wide.

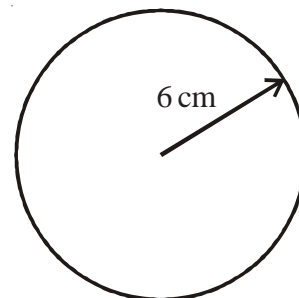

b) Work out the greatest number of CDs which can be cut from one rectangular sheet.

**32**

## Volume of a Prism



- 1) The diagram shows a cuboid.

Work out the volume of the cuboid.

**22500 cm<sup>3</sup>**

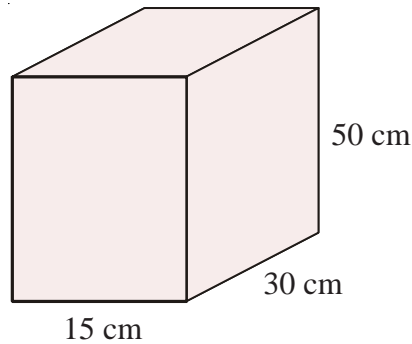

- 2) Calculate the volume of this triangular prism.

**54 cm<sup>3</sup>**

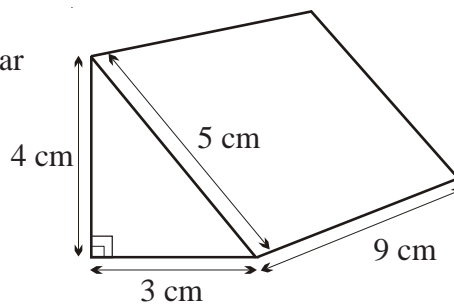

- 3) An ice hockey puck is in the shape of a cylinder with a radius of 3.8 cm and a thickness of 2.5 cm.

Work out the volume of the puck.  
Give your answer correct to 3 significant figures.

**113 cm<sup>3</sup>**

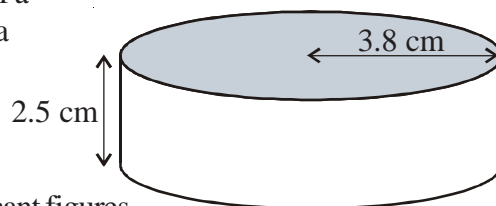

- 4) A cuboid has: a volume of 80cm<sup>3</sup>  
a length of 5 cm  
a width of 2 cm

Work out the height of the cuboid. **20 cm**



- 5) Work out the maximum number of boxes which can fit in the carton.

**160**

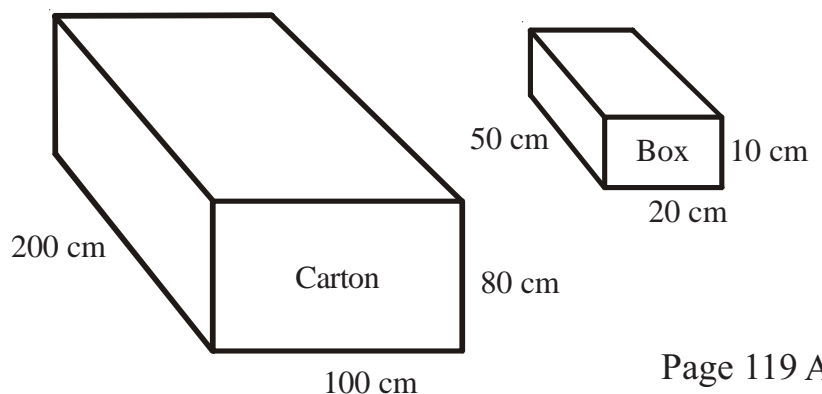

- 1) Work out the volume of the prism. **180 cm<sup>3</sup>**

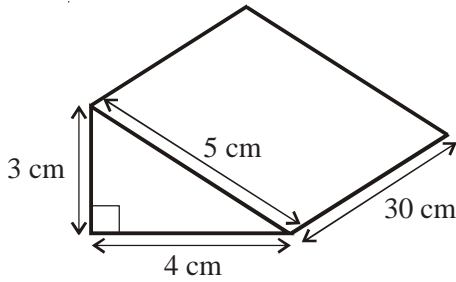

- 2)

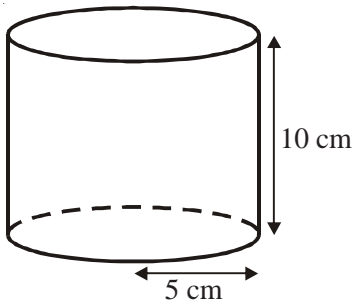

A solid cylinder has a radius of 5 cm and a height of 10 cm.  
Work out the volume of the cylinder.  
Give your answer correct to 3 significant figures.

**786 cm<sup>3</sup>**

- 3)

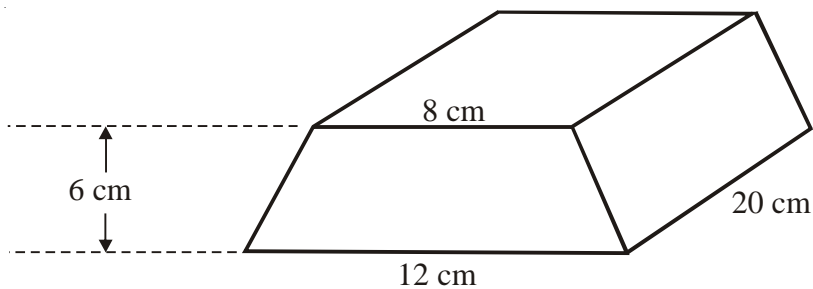

The diagram shows a solid prism made from metal.  
The cross-section of the prism is a trapezium.

Find the volume of the prism.

You must state your units. **1200 cm<sup>3</sup>**

- 1) Line  $PQ$  is parallel to line  $RS$ .  
If angle  $PQR$  is equal to  $36^\circ$
- a) What is the size of angle  $QRS$ ?  $36^\circ$
- b) Give a reason for your answer. **Alternate angles**

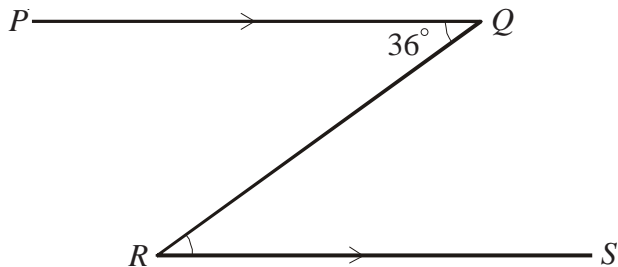

- 2) Line  $DCE$  is parallel to line  $AB$
- a) Find the size of angle  $ABC$   $33^\circ$
- b) Find the size of angle  $DCA$   $68^\circ$
- c) Calculate the size of angle  $ACB$   $79^\circ$

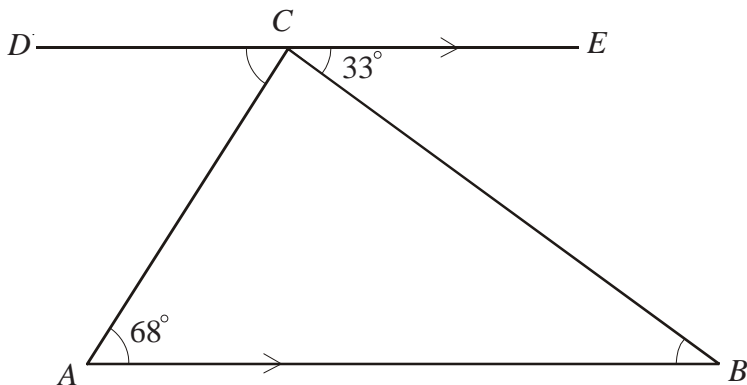

- 3) a) Find the size of angle  $DBF$   $54^\circ$
- b) Find the size of angle  $HGC$   $136^\circ$

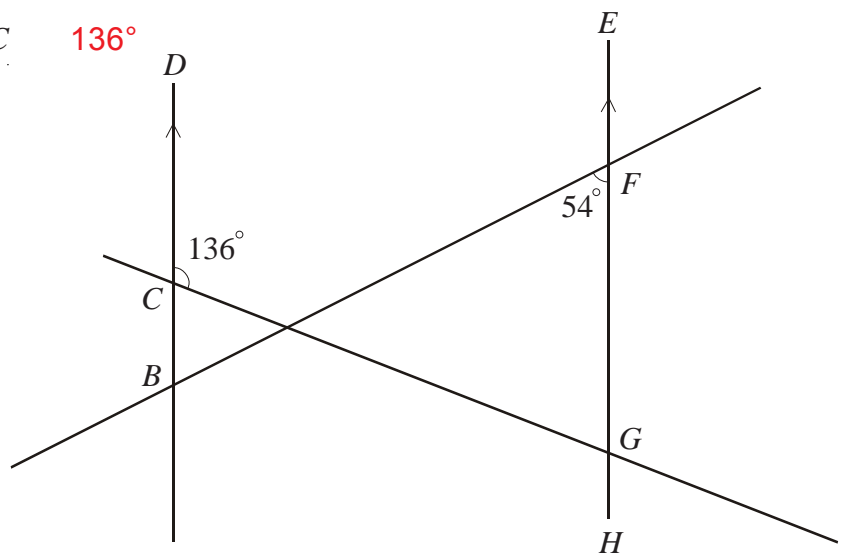

1)

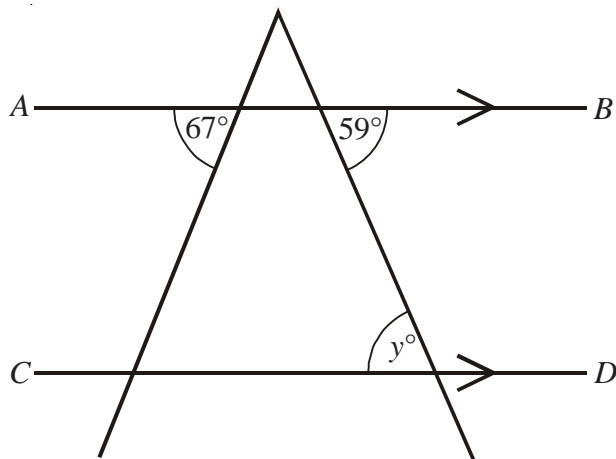

$AB$  is parallel to  $CD$ .

- (i) Write down the value of  $y$ .  $59^\circ$   
 (ii) Give a reason for your answer. **Alternate angles**

2)

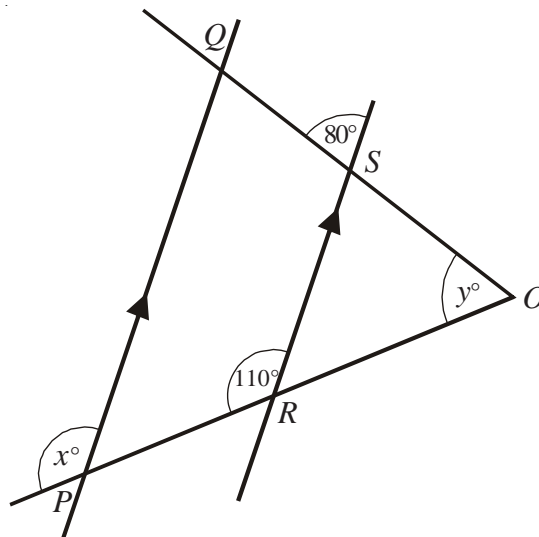

$PQ$  is parallel to  $RS$ .

$OSQ$  and  $ORP$  are straight lines.

- a) (i) Write down the value of  $x$ .  $110^\circ$   
 (ii) Give a reason for your answer. **Corresponding angles**

- b) Work out the value of  $y$ .  $30^\circ$

1)

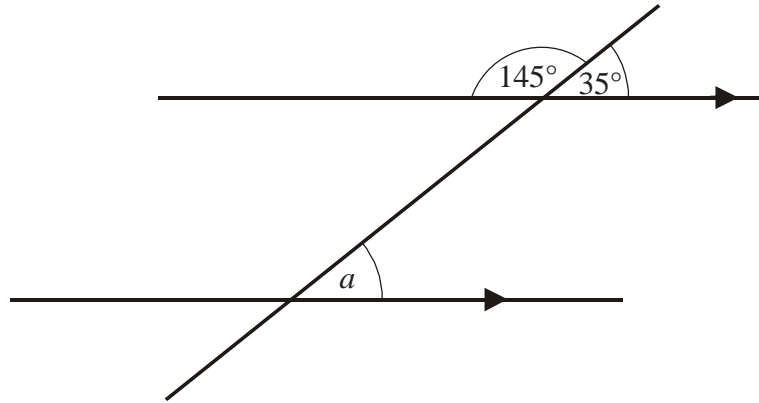

(i) Write down the size of the angle marked  $a$ .  $35^\circ$

(ii) Give a reason for your answer. **Corresponding angles**

2)

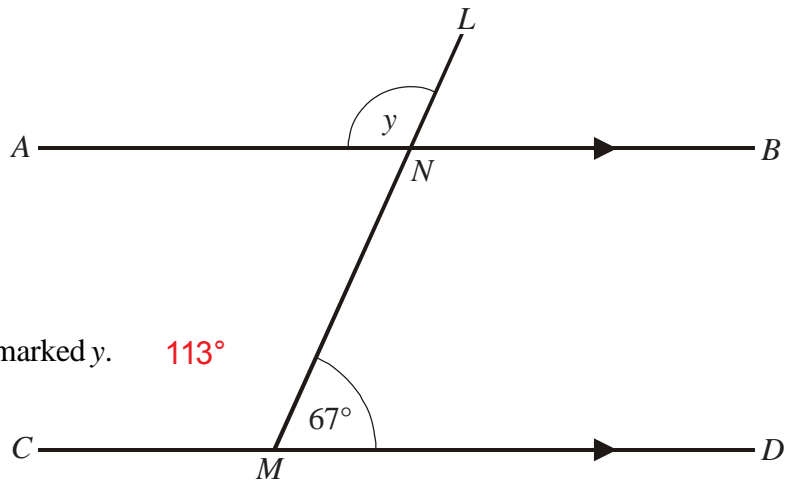

$ANB$  is parallel to  $CMD$ .

$LNM$  is a straight line.

Angle  $LMD = 67^\circ$

(i) Work out the size of the angle marked  $y$ .  $113^\circ$

(ii) Give reasons for your answer.

**Angle  $LNB = 67^\circ$**

**(corresponding angles)**

**$y = 113^\circ$  (angles on straight**

**line add up to  $180^\circ$ )**

3)

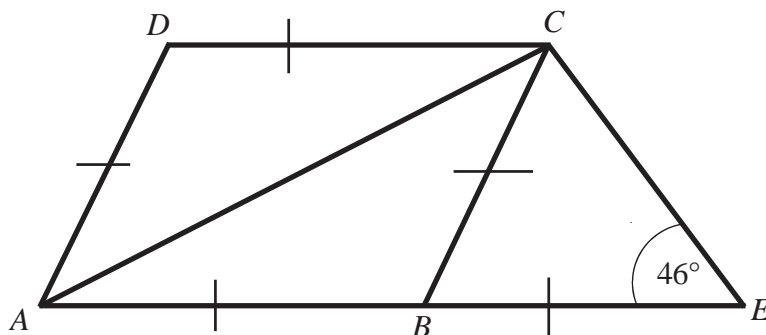

$ABCD$  is a rhombus.

$BCE$  is an isosceles triangle.

$ABE$  is a straight line.

Work out the size of angle  $DCA$ .  $44^\circ$



## Angles in a Triangle

- 1) Work out the size of angle  $a$ .  $44^\circ$

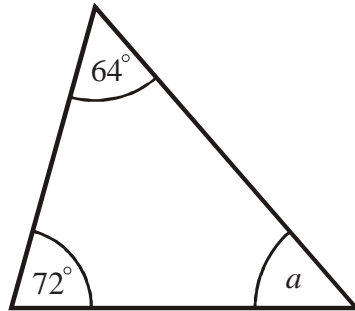

- 2) Work out the size of angle  $b$ .  $100^\circ$

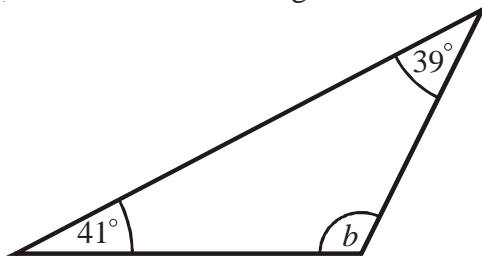

- 3) Work out the size of angle  $c$ .  $123^\circ$

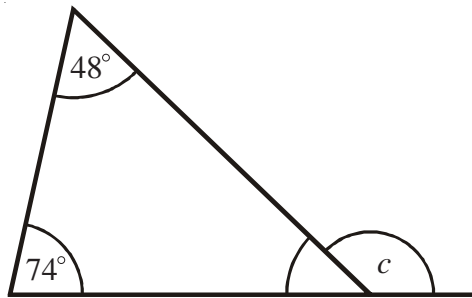

- 4) Work out the size of angle  $d$ .  $85^\circ$

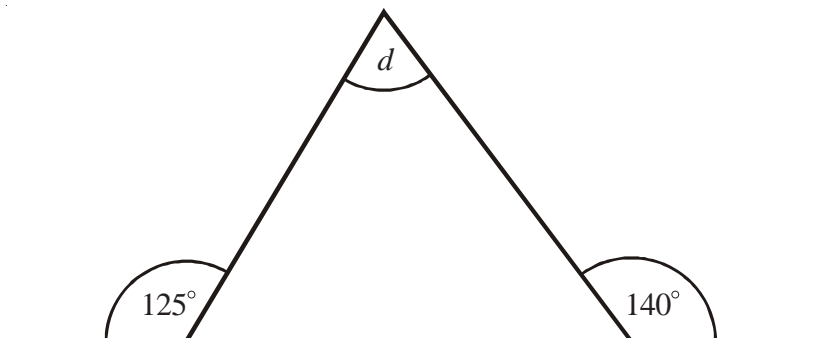

## Properties of Special Triangles

1)  $ABC$  is a triangle.

a) Find the size of angle  $A$ .  $60^\circ$

b) Triangle  $ABC$  is equilateral.

Explain why. **All of the angles are equal.**

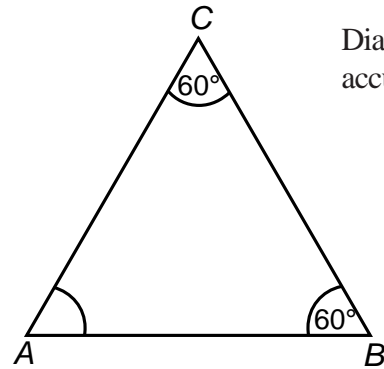

Diagram **NOT** accurately drawn

2)  $BCD$  is a triangle.

$ABC$  is a straight line.

Angle  $CBD = 70^\circ$ .

$BD = CD$ .

a) (i) Work out the value of  $x$ .  $110^\circ$

(ii) Give a reason for your answer.

**Angles on a straight line add up to  $180^\circ$ .**

b) (i) Work out the value of  $y$ .  $40^\circ$

(ii) Give reasons for your answer.

**Base angles of an isosceles triangle are equal.**

**Angles in a triangle add up to  $180^\circ$ .**

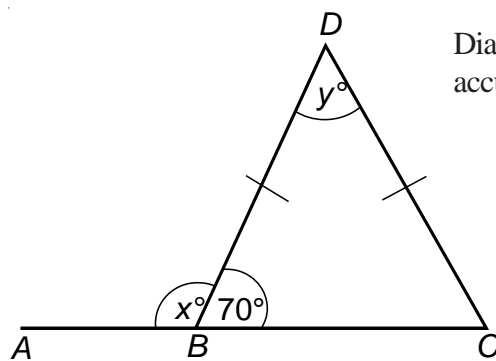

Diagram **NOT** accurately drawn

3) The diagram shows a 5-sided shape.

All the sides of the shape are equal in length.

a) (i) Find the value of  $x$ .  $60^\circ$

(ii) Give a reason for your answer.

**Equilateral triangle**

b) (i) Work out the value of  $y$ .

$150^\circ$

(ii) Explain your answer.

**Angle in square + angle in equilateral triangle =  $90^\circ + 60^\circ = 150^\circ$**

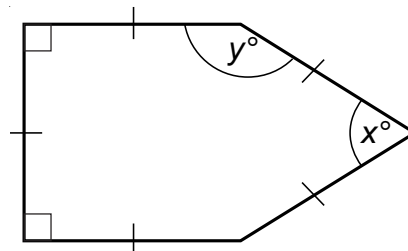

## Angle Sum of Polygons

1)

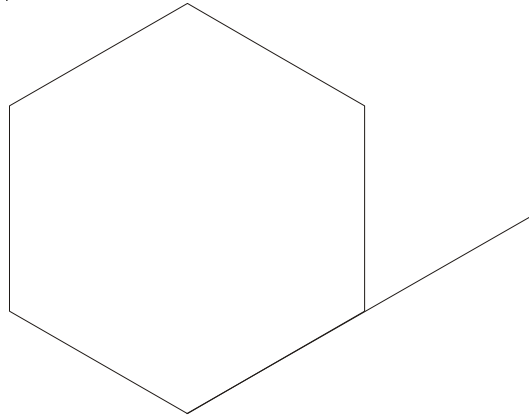

- a) Work out the size of an **exterior** angle of a regular hexagon.  $60^\circ$   
b) Work out the size of an **interior** angle of a regular hexagon.  $120^\circ$

2)

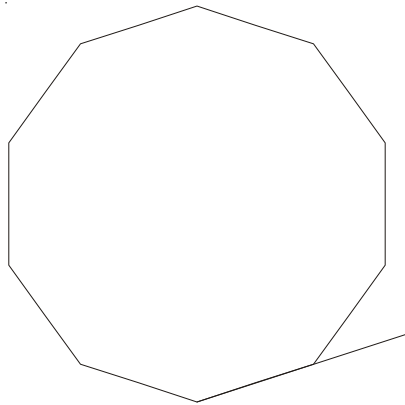

- a) Name the regular polygon, above. **Decagon**  
b) Work out the size of an **exterior** angle and of an **interior** angle for this polygon.  
**Exterior angle =  $36^\circ$**   
**Interior angle =  $144^\circ$**

- 3) The size of each **exterior** angle of a regular polygon is  $40^\circ$ .  
Work out the number of sides of the regular polygon. **9**
- 4) The size of each **interior** angle of a regular polygon is  $120^\circ$ .  
Work out the number of sides of the regular polygon. **6**



1) The diagram shows a regular hexagon and a square.

Calculate the size of the angle  $a$ .

150°

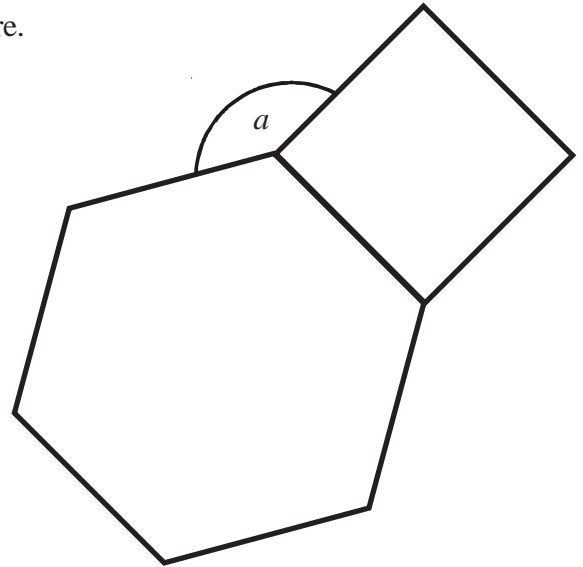

2)

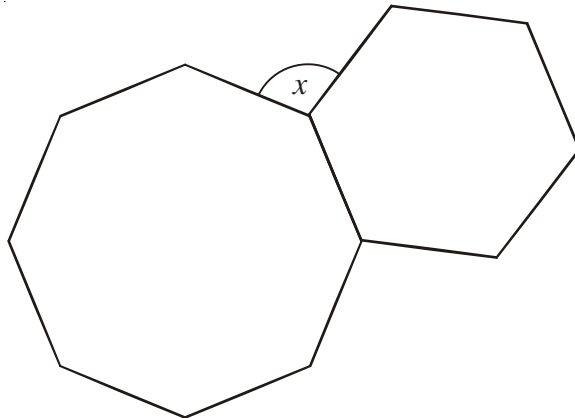

The diagram shows a regular octagon and a regular hexagon.

Work out the size of angle  $x$ . 105°



3)  $ABCDE$  and  $PQRSE$  are regular pentagons.

$AES$  is an equilateral triangle.

Work out the size of angle  $DEP$ . 84°

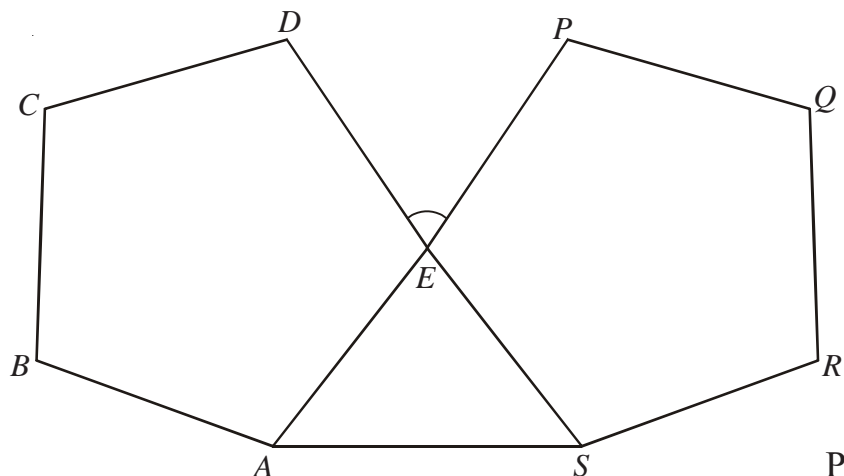

# Bearings

1) The diagram shows the position of two telephone masts,  $A$  and  $B$ , on a map.

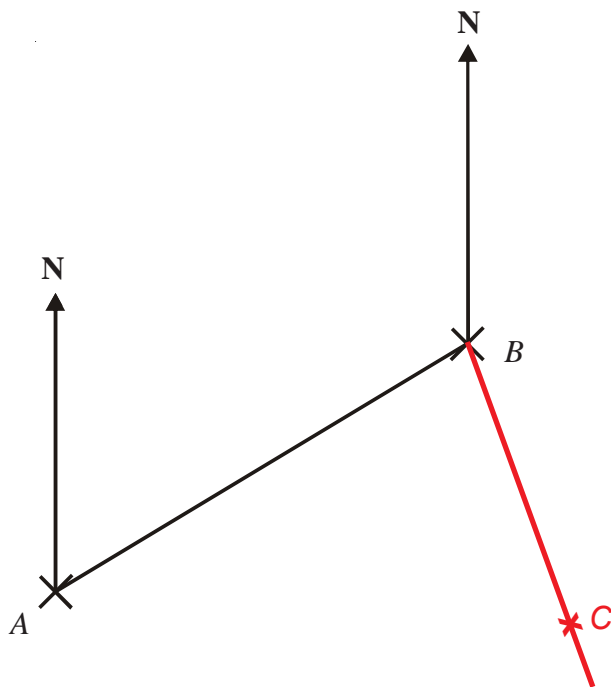

a) Measure the bearing of  $B$  from  $A$ . **059°**

Another mast  $C$  is on a bearing of  $160^\circ$  from  $B$ .  
On the map,  $C$  is 4 cm from  $B$ .

b) Mark the position of  $C$  with a cross and label it  $C$ .

2) The diagram shows the positions of two boats,  $P$  and  $Q$ .

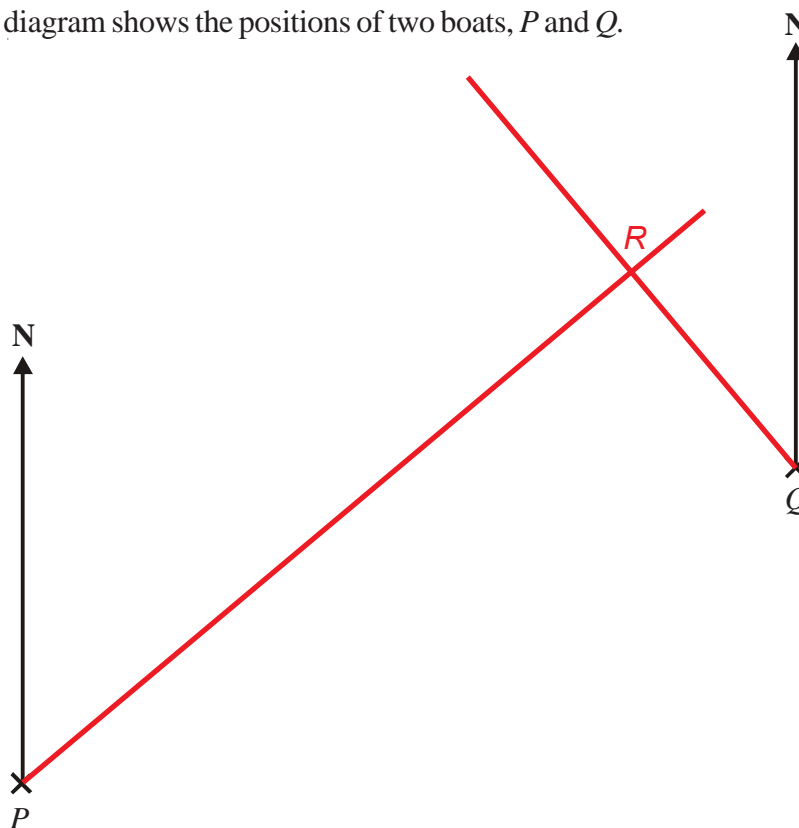

The bearing of a boat  $R$  from boat  $P$  is  $050^\circ$

The bearing of boat  $R$  from boat  $Q$  is  $320^\circ$

In the space above, draw an accurate diagram to show the position of boat  $R$ .  
Mark the position of boat  $R$  with a cross ( $\times$ ). Label it  $R$ .

- 1) School  $B$  is due east of school  $A$ .  
 $C$  is another school.  
 The bearing of  $C$  from  $A$  is  $065^\circ$ .  
 The bearing of  $C$  from  $B$  is  $313^\circ$ .

Complete the scale drawing below.  
 Mark with a cross the position of  $C$ .

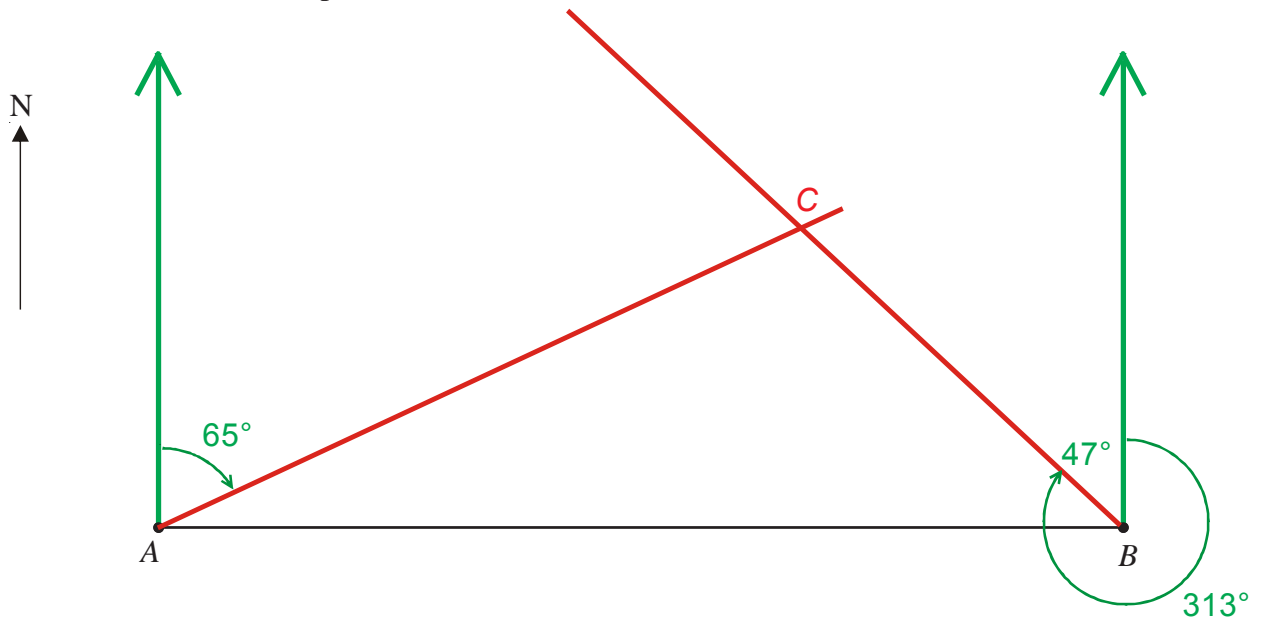

- 2) In the diagram, point  $A$  marks the position of Middlewich.  
 The position of Middlemarch is to be marked on the diagram as point  $B$ .  
 On the diagram, mark with a cross the position of  $B$  given that:

$B$  is on a bearing of  $320^\circ$  from  $A$  and  
 $B$  is 5 cm from  $A$

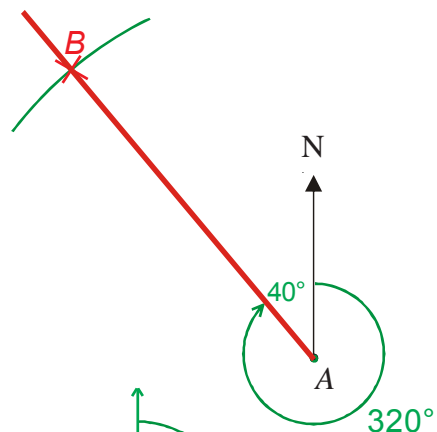

- 3) **Work out** the bearing of  
 a)  $B$  from  $P$   $222^\circ$   
 b)  $P$  from  $A$   $244^\circ$

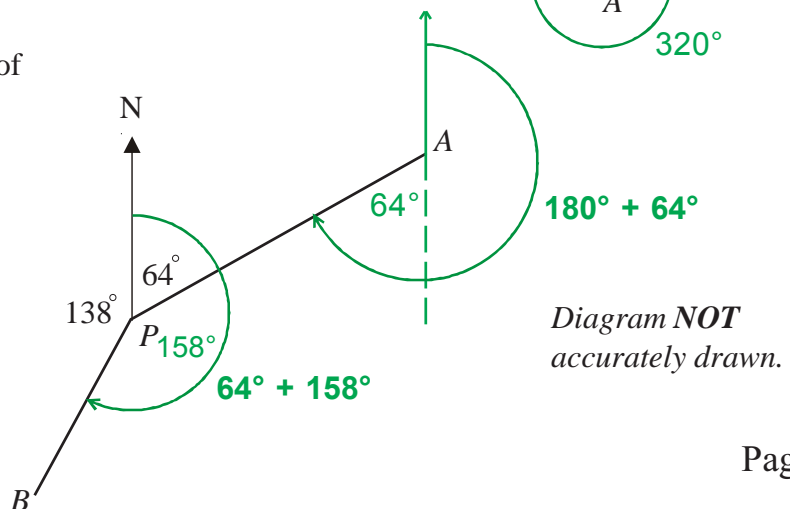

- 1) Ahmad does a statistical experiment.  
He throws a dice 600 times.  
He scores one, 200 times.  
Is the dice fair? Explain your answer    **Two possible answers:**  
**No, you would expect to score 1 about 100 times.**  
**Yes, although you would expect 1 about 100 times, you could still get it 200 times.**
  
- 2) Chris has a biased coin.  
The probability that the biased coin will land on a tail is 0.3  
Chris is going to flip the coin 150 times.  
Work out an estimate for the number of times the coin will land on a tail.    **45 times**
  
- 3) On a biased dice, the probability of getting a six is  $\frac{2}{3}$ .  
The dice is rolled 300 times.  
Work out an estimate for the number of times the dice will land on a six.    **200 times**
  
- 4) On a biased dice, the probability of getting a three is 0.5  
The dice is rolled 350 times.  
Work out an estimate for the number of times the dice will land on a three.    **175 times**
  
- 5) Jenny throws a biased dice 100 times.  
The table shows her results.

Score	Frequency
1	15
2	17
3	10
4	24
5	18
6	16

- a) She throws the dice once more.  
Find an estimate for the probability that she will get a four.     **$\frac{24}{100}$  or 0.24**
  
- b) If the dice is rolled 250 times, how many times would you expect to get a five?    **45 times**

- 1) Two dice are rolled and their scores are multiplied together.  
a) Complete the possibility space to show all the possible results.

		First dice					
		1	2	3	4	5	6
Second dice	1	1	2	3	4	5	6
	2	2	4	6	8	10	12
	3	3	6	9	12	15	18
	4	4	8	12	16	20	24
	5	5	10	15	20	25	30
	6	6	12	18	24	30	36

- b) What is the probability of getting a result that is an even number?  $\frac{27}{36}$

- 2) Suppose there are three cards:

A **black card** that is black on both sides,

A **white card** that is white on both sides,

A **mixed card** that is black on one side and white on the other side.

All the cards are placed into a hat and one is taken out at random.

It is placed on a table and the side facing up is black.

What is the probability that the other side of the card is also black?  $\frac{1}{2}$



## Venn Diagrams

- 1) The Venn diagram shows the number of students studying one or more of the sciences Chemistry, Biology and Physics.

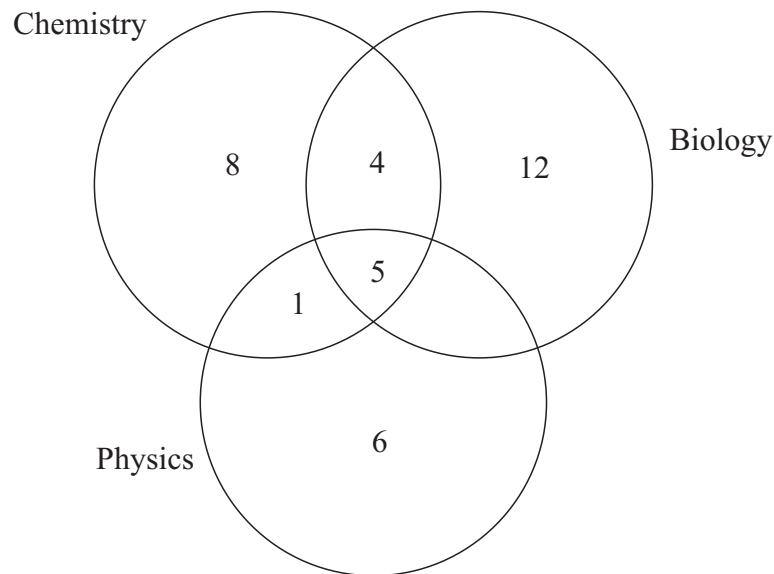

- a) How many students are represented in this Venn diagram? **36**
- b) How many students are studying exactly two sciences? **5**
- c) What is the probability that a student chosen at random is not studying Physics?  **$\frac{24}{36}$**
- 2) There are 31 student who study languages.  
 All 31 study at least one of Spanish, French or German.  
 4 study all three languages.  
 9 study Spanish and French.  
 7 study French and German.  
 6 study Spanish and German.  
 7 study only French and 5 study only German.  
 Complete the Venn diagram to show this information.

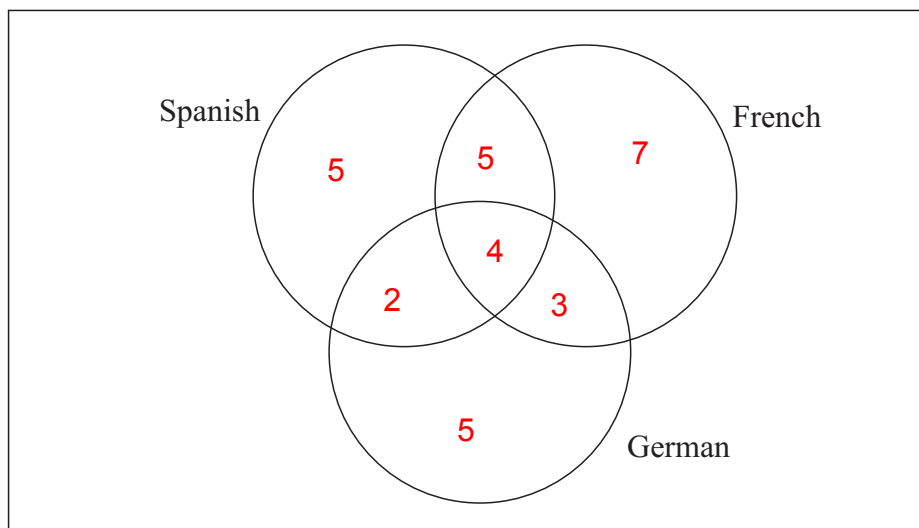

## Representing Data

- 1) Patrick asked some of his colleagues which was their favourite holiday destination. The table shows the results.

City	Frequency	Angle
Alicante	8	72°
Paris	7	63°
Ibiza	15	135°
St Lucia	1	9°
Biarritz	9	81°

Draw a pie chart to illustrate the information.

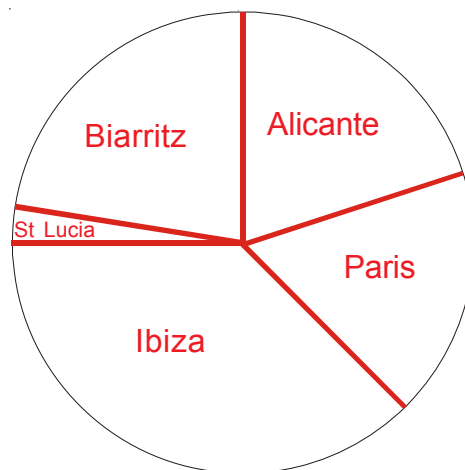

- 2) Brian asked 60 people which region their favourite rugby team came from. The table shows the results.

Region	Frequency	Angle
Southern England	9	54°
London	23	138°
Midlands	16	96°
Northern England	12	72°
Total	60	

Draw a pie chart to illustrate the information.

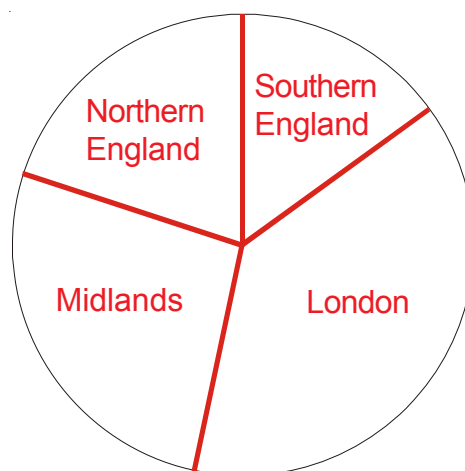

- 3) The stem and leaf diagram, below, shows information about the times, in minutes, it takes a group of people to eat their breakfast.

0		5	7	9	
1		0	0	5	8
2		0	2	3	5
3		2	5		

Key: 1|0 represents 10 minutes.

- a) How many people are in the group? **15 people**
- b) How many people spend 15 minutes or more eating their breakfast? **10 people**
- c) Find the median time that it took to eat breakfast. **18 minutes**

## Scatter Diagrams

- 1) The scatter graph shows some information about the marks of six students. It shows each student's marks in Maths and Science.

The table below shows the marks for four more students.

Maths	22	8	17	26
Science	30	12	24	24

- On the scatter graph, plot the information from the table.
- Draw a line of best fit.
- Describe the correlation between the marks in Maths and the marks in Science.

**There is a positive correlation**

Another student has a mark of 18 in Science.

- Use the line of best fit to estimate the mark in Maths of this student.

**My answer is 14. Yours will depend on your line of best fit.**

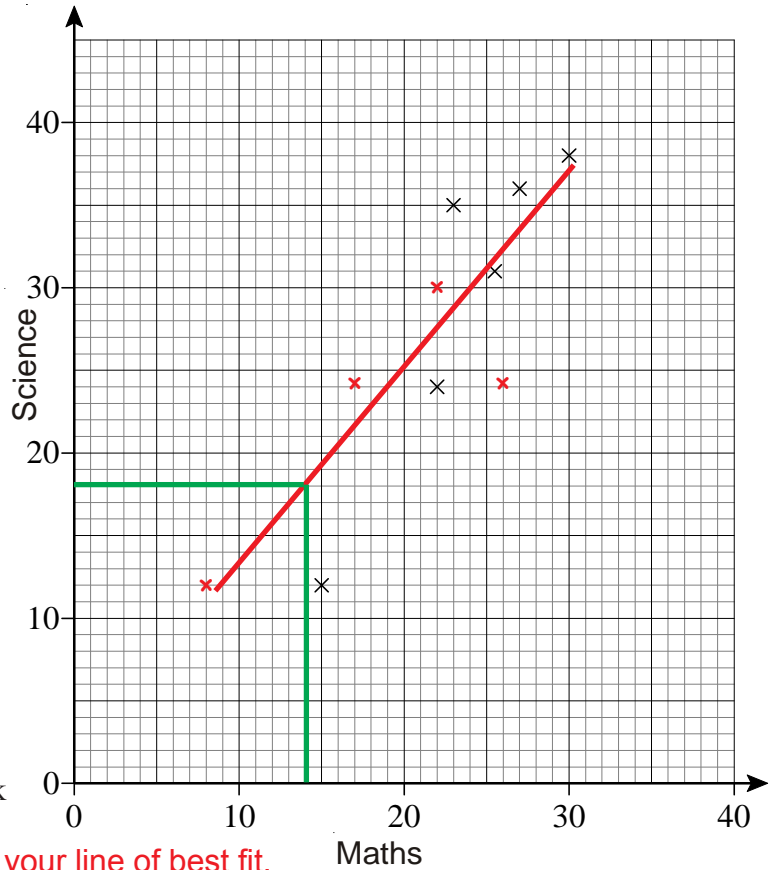

- 2) The table below shows the average daily number of hours sleep of 10 children.

Age (years)	4	2	5	1	9	6	8	7	10	1.5
Number of hours sleep	14	13	12.5	15	10	12.5	10.8	12	11	14

The first five results have been plotted on the scatter diagram.

- Plot the next five points.
- Draw a line of best fit.
- Describe the relationship between the age of the children and their number of hours sleep per day.
- Use your scatter graph to estimate the number of hours sleep for a 3 year old child.

**My answers is 13.6  
Yours will depend on your line of best fit.**

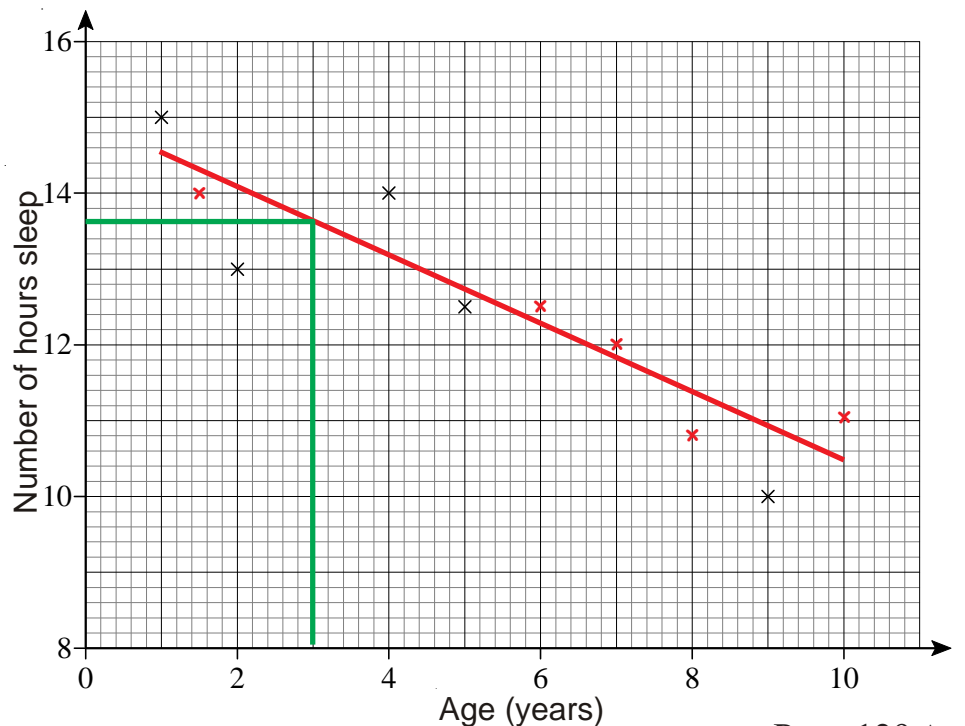

## Scatter Diagrams

- 1) Sue did an experiment to study the times, in minutes, it took 1 cm ice cubes to melt at different temperatures.  
Some information about her results is given in the scatter graph.

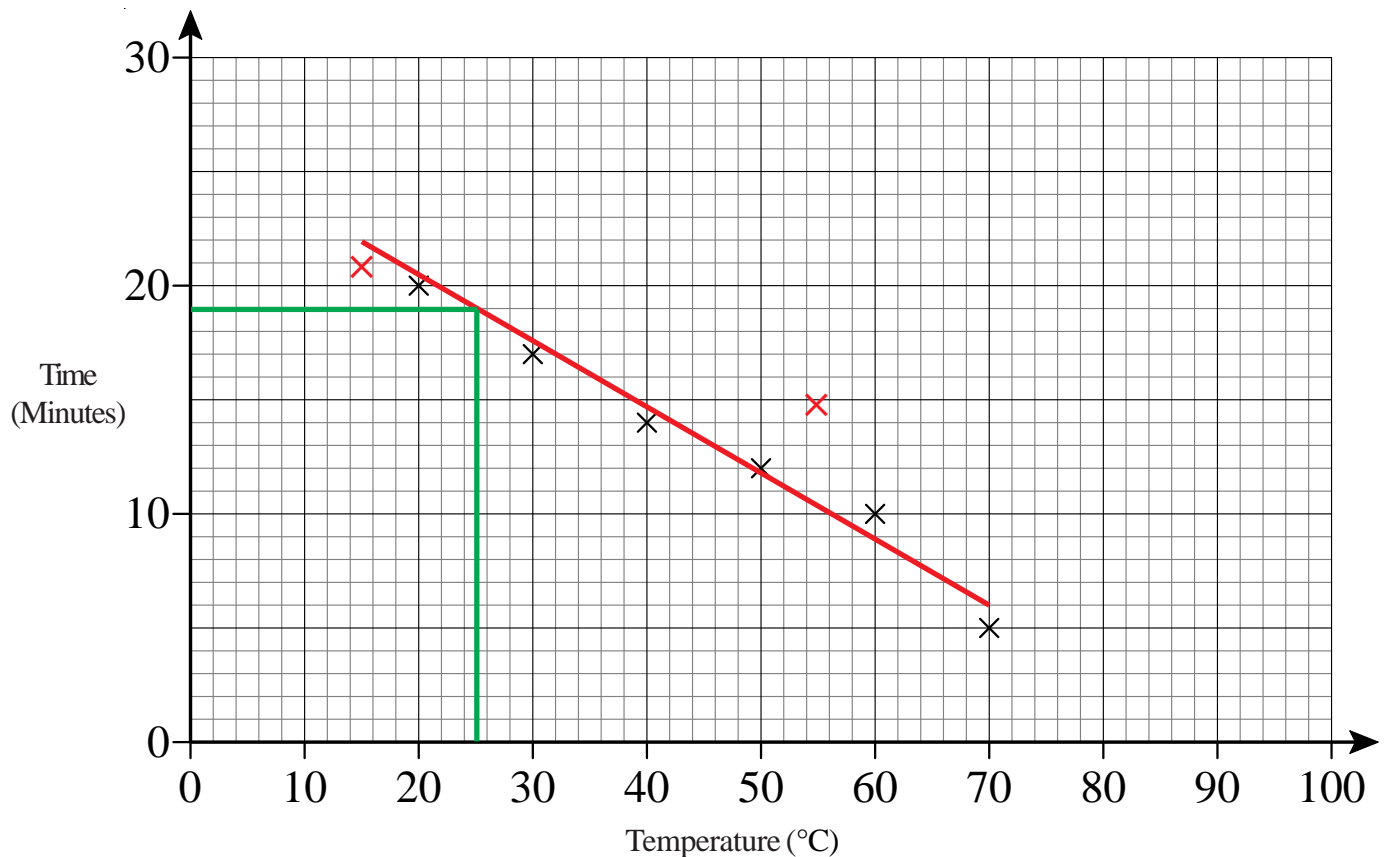

The table shows the results from two more experiments.

<b>Temperature (°C)</b>	15	55
<b>Time (Minutes)</b>	21	15

- On the scatter graph, plot the results from the table.
- Describe the relationship between the temperature and the time it takes a 1 cm ice cube to melt. **Negative correlation**
- Find an estimate for the time it takes a 1 cm ice cube to melt when the temperature is 25 °C. **19 minutes (your answer will depend on your line of best fit)**

Sue's data cannot be used to predict how long it will take a 1 cm ice cube to melt when the temperature is 100 °C.

- Explain why. **Line of best fit would give a negative time or  
You cannot draw and use a line of best fit which goes beyond the values.**

## Scatter Diagrams

- 1) Henry reads eight books.

For each book he recorded the number of pages and the time he took to read it.

The scatter graph shows information about his results.

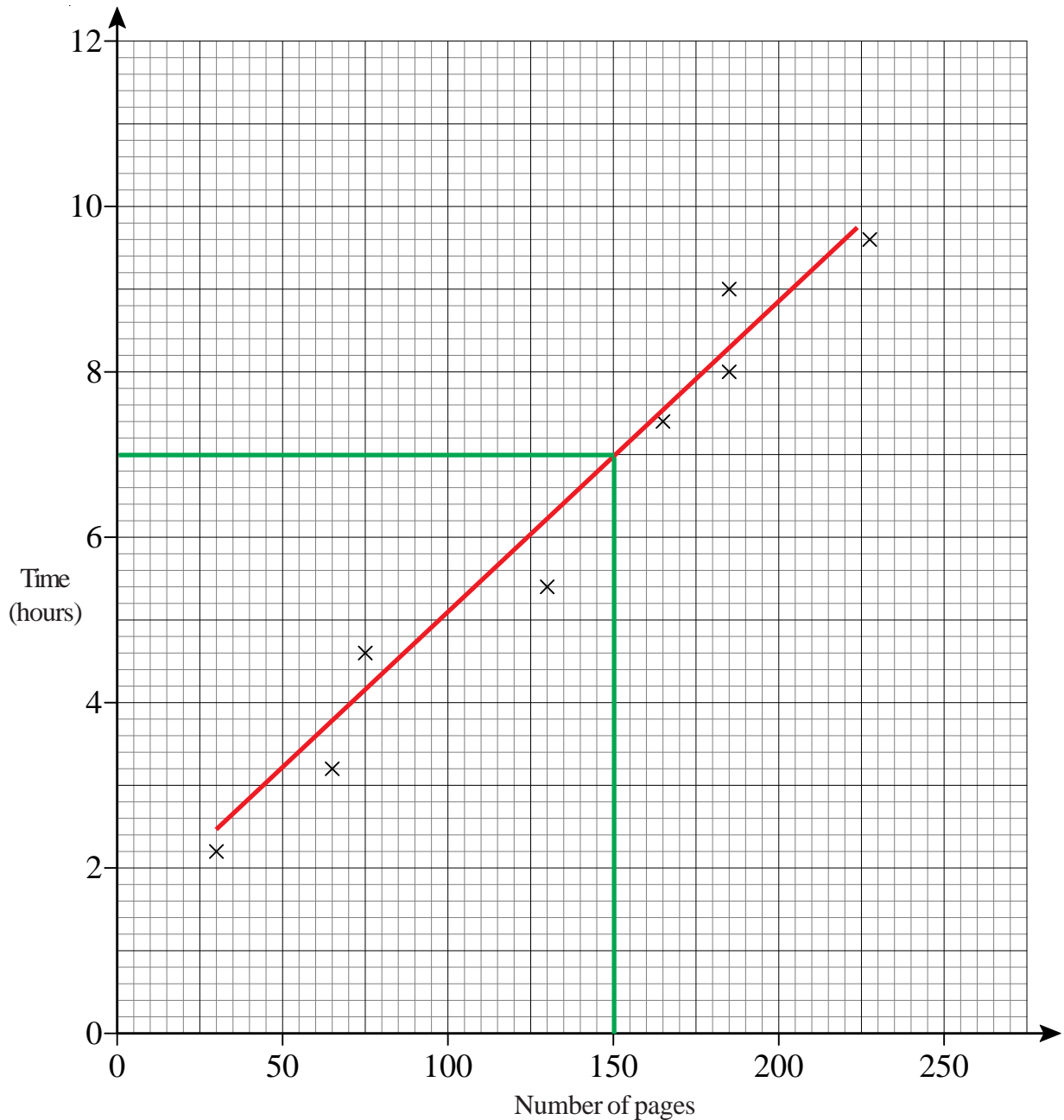

- a) Describe the relationship between the number of pages in a book and the time Henry takes to read it. **Positive correlation**

Henry reads another book.

The book has 150 pages.

- b) Estimate the time it takes Henry to read it. **7 hours** (your answer will depend on your line of best fit)

## Scatter Diagrams

1) Mr Jones sells umbrellas.

The scatter graph shows some information about the number of umbrellas he sold and the rainfall, in cm, each month last year.

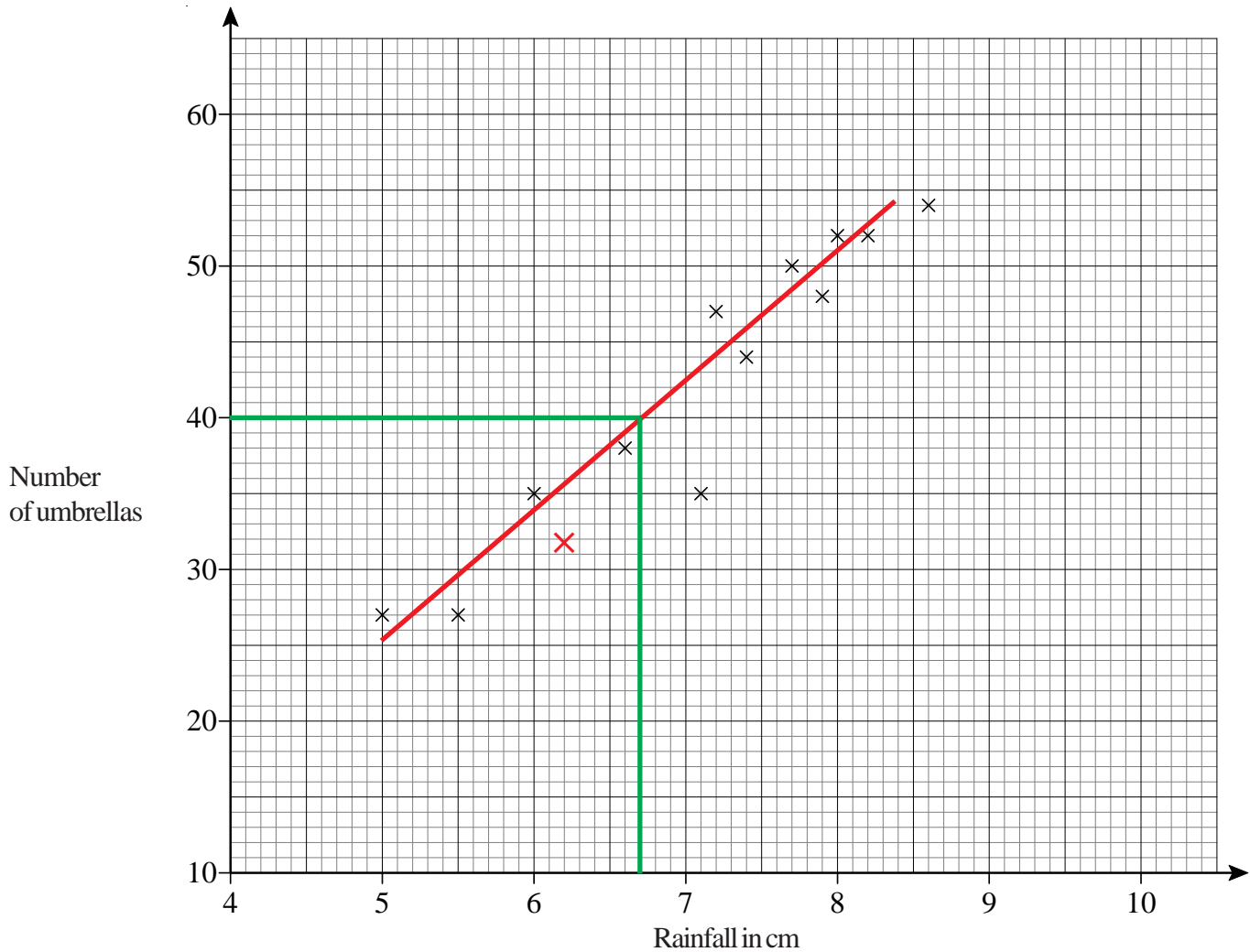

In January of this year, the rainfall was 6.2 cm.

During January, Mr Jones sold 32 umbrellas.

a) Show this information on the scatter graph.

b) What type of correlation does this scatter graph show? **Positive correlation**

In February of this year, Mr Jones sold 40 umbrellas.

c) Estimate the rainfall for February. **6.7 cm** (your answer will depend on your line of best fit)



- 1) The number of pens in each pupil's pencil case in a classroom has been counted. The results are displayed in a table.

Number of pens	Number of pupils
0	4
1	6
2	7
3	5
4	3
5	1

- a) Work out the total number of pens in the classroom. **52**
- b) Write down the modal number of pens in a pencil case. **2**
- c) Work out the mean number of pens in a pencil case. **2**
- d) Work out the range of the number of pens in a pencil case. **5**



- 2) Thomas is analysing the local football team. He records the number of goals scored in each football match in the past twelve months.

Goals scored	Frequency
0	7
1	5
2	3
3	6
4	2
5	1
6	1

Thomas said that the mode is 7  
Thomas is wrong.

- a) Explain why. **Thomas gave the highest frequency instead of giving the number of 'goals scored' associated with it.**
- b) Calculate the mean number of goals scored. **1.92**



- 3) Sindy recorded the time, in minutes, that her train was late over 100 days. Information about these times is shown in the table.

Time ( $t$ minutes)	Frequency	Midpoint	MP $\times$ Frequency
$0 < t < 6$	15	3	45
$6 < t < 12$	23	9	207
$12 < t < 18$	28	15	420
$18 < t < 24$	19	21	399
$24 < t < 30$	15	27	405
	<b>100</b>		<b>1476</b>

Calculate an estimate for the mean time that her train was late. Give your answer to 1 decimal place. **14.8 minutes**

1) Write as a power of 8

a)  $8^4 \times 8^3$   $8^7$       b)  $8^{12} \div 8^7$   $8^5$

2) Write as a power of 3

a)  $3^2 \times 3^9$   $3^{11}$       b)  $3^{10} \div 3^3$   $3^7$

3) Simplify

a)  $k^5 \times k^2$   $k^7$

b)  $x^4 \div x^2$   $x^2$

c)  $\frac{k^{11}}{k^6}$   $k^5$

d)  $(k^8)^2$   $k^{16}$

4) Simplify

eg.  $(2xy^3)^4 = 2xy^3 \times 2xy^3 \times 2xy^3 \times 2xy^3 = 16x^4y^{12}$

a)  $(2xy^5)^3$   $8x^3y^{15}$

b)  $(2x^2y^2)^3$   $8x^6y^6$

c)  $(4xy^4)^2$   $16x^2y^8$

d)  $(3xy^2)^4$   $81x^4y^8$

5)  $2^x \times 2^y = 2^{10}$

and

$2^x \div 2^y = 2^2$

Work out the value of  $x$  and the value of  $y$ .  $x = 6, y = 4$

6)  $5^x \times 5^y = 5^{12}$

and

$5^x \div 5^y = 5^6$

Work out the value of  $x$  and the value of  $y$ .  $x = 9, y = 3$

7)  $a = 2^x, b = 2^y$

Express in terms of  $a$  and  $b$

a)  $2^{x+y}$   $ab$

b)  $2^{2x}$   $a^2$

c)  $2^{3y}$   $b^3$

d)  $2^{x+2y}$   $ab^2$



## Index Notation

- 1) a) Simplify  $d \times d \times d \times d$   $d^4$   
b) Simplify  $t \times t^2$   $t^3$   
c) Simplify  $m^5 \div m^3$   $m^2$
- 2) a) Simplify  $(2x^2)^3$   $8x^6$   
b) Simplify  $3x^2 \times 4x^5y^4$   $12x^7y^4$
- 3) a) Simplify  $t^4 \times t^5$   $t^9$   
b) Simplify  $x^8 \div x^5$   $x^3$   
c) Simplify  $(c^4)^3$   $c^{12}$
- 4) a) Simplify  $x^6 \times x^2$   $x^8$   
b) Simplify  $\frac{x^8}{x^3}$   $x^5$   
c) Simplify  $(2t)^3$   $8t^3$   
d) Simplify  $3x^2y \times 4x^5y^4$   $12x^7y^5$
- 5) a) Simplify  $x^3 \times x^4$   $x^7$   
b) Simplify  $t^7 \div t^3$   $t^4$   
c) Simplify  $4x^2y^4 \times 3xy^2$   $12x^3y^6$
- 6) a) Simplify  $x \times x \times x \times x$   $x^4$   
b) Simplify  $2x \times 3y$   $6xy$

## Introduction to Bounds

1) A silver necklace has a mass of 123 grams, correct to the nearest gram.

- a) Write down the least possible mass of the necklace. **122.5 g**
- b) Write down the greatest possible mass of the necklace. **123.5 g**

2) Each of these measurements was made correct to one decimal place.

Write the maximum and minimum possible measurement in each case.

- |                     |                     |                        |                        |
|---------------------|---------------------|------------------------|------------------------|
| a) 4.6 cm           | b) 0.8 kg           | c) 12.5 litres         | d) 25.0 km/h           |
| max: <b>4.65 cm</b> | max: <b>0.85 kg</b> | max: <b>12.55 l</b>    | max: <b>25.05 km/h</b> |
| min: <b>4.55 cm</b> | min: <b>0.75 kg</b> | min: <b>12.45 l</b>    | min: <b>24.95 km/h</b> |
| e) 10.3 s           | f) 36.1 m           | g) 136.7 m/s           | h) 0.1 g               |
| max: <b>10.35 s</b> | max: <b>36.15 m</b> | max: <b>136.75 m/s</b> | max: <b>0.15 g</b>     |
| min: <b>10.25 s</b> | min: <b>36.05 m</b> | min: <b>136.65 m/s</b> | min: <b>0.05 g</b>     |



3) Each side of a regular octagon has a length of 20.6 cm, correct to the nearest millimetre.

- a) Write down the least possible length of each side. **20.55 cm**
- b) Write down the greatest possible length of each side. **20.65 cm**
- c) Write down the greatest possible perimeter of the octagon. **165.2 cm**

4) A girl has a pen that is of length 12 cm, measured to the nearest centimetre.

Her pencil case has a diagonal of length 12.5 cm, measured to the nearest millimetre.

Explain why it might not be possible for her to fit the pen in the pencil case.

- 12 cm to the nearest cm has a maximum possible length of 12.5 cm.**  
**12.5 cm to the nearest mm has a minimum possible length of 12.45 cm.**  
**A 12.5 cm pencil won't fit into a pencil case with a diagonal length of 12.45 cm.**



5) A square has sides of length 7 cm, correct to the nearest centimetre.

- a) Calculate the lower bound for the perimeter of the square. **26 cm**
- b) Calculate the upper bound for the area of the square. **56.25 cm<sup>2</sup>**

## Midpoint of a Line on a Graph

- 1) Find the midpoint of  $A$  and  $B$  where  $A$  has coordinates  $(-2, 5)$  and  $B$  has coordinates  $(4, -1)$ .

$(1, 2)$

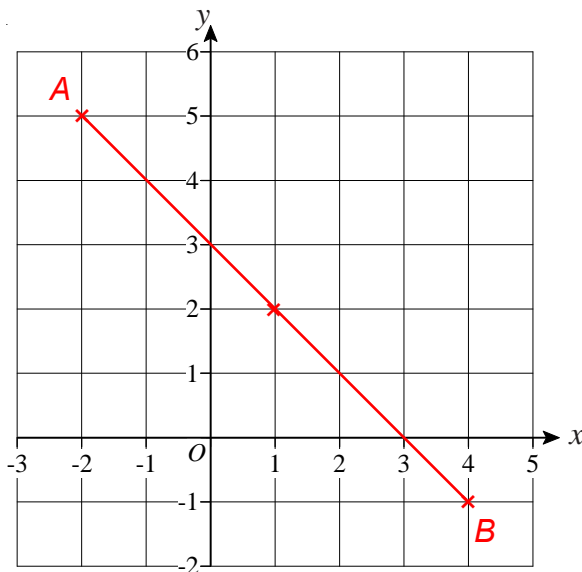

- 2) Find the midpoint of  $A$  and  $B$  where  $A$  has coordinates  $(2, 0)$  and  $B$  has coordinates  $(8, 6)$ .  $(5, 3)$
- 3) Find the midpoint of  $A$  and  $B$  where  $A$  has coordinates  $(-4, -2)$  and  $B$  has coordinates  $(2, 4)$ .  $(-1, 1)$
- 4) Find the midpoint of  $A$  and  $B$  where  $A$  has coordinates  $(-3, -2)$  and  $B$  has coordinates  $(7, 5)$ .  $(2, 1.5)$
- 5) Find the midpoint of  $A$  and  $B$  where  $A$  has coordinates  $(2, -5)$  and  $B$  has coordinates  $(7, 4)$ .  $(4.5, -0.5)$
- 6) Find the midpoint of  $A$  and  $B$  where  $A$  has coordinates  $(-7, -4)$  and  $B$  has coordinates  $(-2, -1)$ .  $(-4.5, -2.5)$
- 7) The midpoint of  $A$  and  $B$  is at  $(1, 3)$ .  
The coordinates of  $A$  are  $(-2, 4)$ .  
Work out the coordinates of  $B$ .  $(4, 2)$
- 8)  The midpoint of  $A$  and  $B$  is at  $(3.5, 2.5)$ .  
The coordinates of  $A$  are  $(2, 5)$ .  
Work out the coordinates of  $B$ .  $(5, 0)$

## Expanding and Simplifying Brackets

1) Expand these brackets

a)  $2(x + 3)$   $2x + 6$

b)  $3(2x + 4)$   $6x + 12$

c)  $5(3p - 2q)$   $15p - 10q$

d)  $4(x^2 + 2y^2)$   $4x^2 + 8y^2$

e)  $6(r - r^2)$   $6r - 6r^2$

2) Expand these brackets

a)  $x(x - 2)$   $x^2 - 2x$

b)  $x(3x + 5)$   $3x^2 + 5x$

c)  $p(3p - 7q)$   $3p^2 - 7pq$

d)  $y(y + 6y^2)$   $y^2 + 6y^3$

e)  $x(r + r^2)$   $xr + xr^2$

3) Expand these brackets

a)  $2x(x - 5)$   $2x^2 - 10x$

b)  $4x(2x + 3)$   $8x^2 + 12x$

c)  $5p(4p - 2q)$   $20p^2 - 10pq$

d)  $2y(3y + 4x^2)$   $6y^2 + 8x^2y$

e)  $x(x + r^2)$   $x^2 + r^2x$

4) Expand these brackets

a)  $x(x^2 - 2)$   $x^3 - 2x$

b)  $3x(2x^3 + 1)$   $6x^4 + 3x$

c)  $5p^2(4p - 2)$   $20p^3 - 10p^2$

d)  $2y^2(3y^3 + 4y)$   $6y^5 + 8y^3$

e)  $2xy(x + y^2)$   $2x^2y + 2xy^3$

5) Expand and simplify

a)  $2(x + y) + 3(x + y)$   $5x + 5y$

b)  $3(2x + y) + 2(5x + 3y)$   $16x + 9y$

c)  $5(x + y) + 3(2x + y)$   $11x + 8y$

d)  $3(2c + d) + 2(c + d)$   $8c + 5d$

e)  $4(2p + q) + 3(2p + q)$   $14p + 7q$

6) Expand and simplify

a)  $2(x + y) + 3(x - y)$   $5x - y$

b)  $5(2x + y) + 2(3x - 2y)$   $16x + y$

c)  $4(x - y) + 3(2x + y)$   $10x - y$

d)  $6(2c - d) + 2(c - d)$   $14c - 8d$

e)  $2(5p - q) + 3(p - 2q)$   $13p - 8q$

7) Expand and simplify

a)  $3(x + 2y) - 3(x - y)$   $9y$

b)  $5(2x - y) - 2(3x - 2y)$   $4x - y$

c)  $7(x - 2y) - 3(2x + y)$   $x - 17y$

d)  $6(2x - y) - 2(x + 2y)$   $10x - 10y$

e)  $2(5p - q) - (p - 3q)$   $9p + q$

## Expanding and Simplifying Brackets

1) Expand and simplify

a)  $(x + 3)(x + 2)$   $x^2 + 5x + 6$

b)  $(x + 5)(x + 3)$   $x^2 + 8x + 15$

c)  $(x + 1)(x + 4)$   $x^2 + 5x + 4$

d)  $(x + 6)(x + 4)$   $x^2 + 10x + 24$

e)  $(x + 5)(x + 7)$   $x^2 + 12x + 35$

2) Expand and simplify

a)  $(x + 5)(x - 2)$   $x^2 + 3x - 10$

b)  $(x - 7)(x + 2)$   $x^2 - 5x - 14$

c)  $(x - 1)(x + 3)$   $x^2 + 2x - 3$

d)  $(x + 4)(x - 3)$   $x^2 + x - 12$

e)  $(x - 5)(x + 5)$   $x^2 - 25$

3) Expand and simplify

a)  $(x - 3)(x - 4)$   $x^2 - 7x + 12$

b)  $(x - 2)(x - 6)$   $x^2 - 8x + 12$

c)  $(x - 1)(x - 1)$   $x^2 - 2x + 1$

d)  $(x - 7)(x - 2)$   $x^2 - 9x + 14$

e)  $(x - 4)(x - 5)$   $x^2 - 9x + 20$

4) Expand and simplify

a)  $(x - 7)(x + 1)$   $x^2 - 6x - 7$

b)  $(p - 6)(p + 4)$   $p^2 - 2p - 24$

c)  $(e - 3)(e - 7)$   $e^2 - 10e + 21$

d)  $(x + 8)(x + 1)$   $x^2 + 9x + 8$

e)  $(x - 5)(x - 5)$   $x^2 - 10x + 25$

5) Expand and simplify

a)  $(2x + 3)(2x + 1)$   $4x^2 + 8x + 3$

b)  $(3p - 4)(2p + 5)$   $6p^2 + 7p - 20$

c)  $(e - 3)(3e - 4)$   $3e^2 - 13e + 12$

d)  $(4x - 6)(2x + 1)$   $8x^2 - 8x - 6$

e)  $(2x - 3)(2x + 3)$   $4x^2 - 9$

6) Expand and simplify

a)  $(2x + y)(3x + 2y)$   $6x^2 + 7xy + 2y^2$



b)  $(3p - 2q)(4p + 5q)$   $12p^2 + 7pq - 10q^2$

c)  $(4e - 3f)(2e - 2f)$   $8e^2 - 14ef + 6f^2$

d)  $(6x - y)(6x + y)$   $36x^2 - y^2$

e)  $(3x - 2y)(x - 5y)$   $3x^2 - 17xy + 10y^2$

## Solving Equations

- 1) Solve  $2x - 3 = 17$   
 $x = 10$
- 2) Solve  $3x + 2 = 14$   
 $x = 4$
- 3) Solve  $5x - 7 = 33$   
 $x = 8$
- 4) Solve  $4x + 7 = 19$   
 $x = 3$
- 5) Solve  $x + x + x + x = 20$   
 $x = 5$
- 6) Solve  $x + 3x = 24$   
 $x = 6$
- 7) Solve  $2(x + 3) = 8$   
 $x = 1$
- 8) Solve  $2(3x - 4) = 22$   
 $x = 5$
- 9) Solve  $5(t - 1) = 20$   
 $t = 5$
- 10) Solve  $3(2x + 5) = 36$   
 $x = 3.5$
- 11) Solve  $2x + 7 = x + 11$   
 $x = 4$
- 12) Solve  $5y - 2 = 3y + 10$   
 $y = 6$
- 13) Solve  $2x + 1 = 5x - 20$   
 $x = 7$
- 14) Solve  $p - 3 = 3p - 11$   
 $p = 4$
- 15) Solve  $2d + 5 = 20 - 3d$   
 $d = 3$
- 16) Solve  $4 - e = 2e - 8$   
 $e = 4$
- 17) Solve  $2(x + 3) = x + 9$   
 $x = 3$
- 18) Solve  $x - 7 = 3(2x - 4)$   
 $x = 1$
- 19) Solve  $5(x + 3) = 2(x + 6)$   
 $x = -1$
- 20) Solve  $4(2y + 1) = 2(12 - y)$   
 $y = 2$
- 21) Solve  $7 - 3x = 2(x + 1)$   
 $x = 1$
- 22) Solve  $\frac{x}{2} = 5$   
 $x = 10$
- 23) Solve  $\frac{x}{5} = 6$   
 $x = 30$
- 24) Solve  $\frac{2x}{3} = 4$   
 $x = 6$
- 25) Solve  $\frac{5x}{2} = 15$   
 $x = 6$
- 26) Solve  $\frac{x - 2}{3} = 1$   
 $x = 5$
- 27) Solve  $\frac{x + 5}{2} = 7$   
 $x = 9$
- 28) Solve  $\frac{2x + 1}{4} = 2$   
 $x = 3.5$
- 29) Solve  $\frac{5x - 3}{3} = 4$   
 $x = 3$
- 30) Solve  $\frac{x + 2}{3} = x + 4$   
 $x = -5$
- 31)  Solve  $\frac{3x - 1}{4} = 2x - 3$   
 $x = 2.2$
- 32)  Solve  $\frac{4x + 3}{5} = \frac{2x - 1}{2}$   
 $x = 5.5$

## Rearranging Simple Formulae

- 1) Make  $c$  the subject of the formula.

$$a = b + cd$$

$$c = \frac{a - b}{d}$$

- 2) Make  $t$  the subject of the formula.

$$u = v + 2t$$

$$t = \frac{u - v}{2}$$

- 3) Make  $n$  the subject of the formula.

$$M = 3n + 5$$

$$n = \frac{M - 5}{3}$$

- 4) Make  $z$  the subject of the formula.

$$x = 3y + z$$

$$z = x - 3y$$

- 5)  $r = 5s + 3t$

a) Make  $t$  the subject of the formula.  $t = \frac{r - 5s}{3}$

b) Make  $s$  the subject of the formula.  $s = \frac{r - 3t}{5}$

- 6) Rearrange  $y = 3x + 1$  to make  $x$  the subject.

$$x = \frac{y - 1}{3}$$

- 7) Rearrange  $y = \frac{1}{2}x + 2$  to make  $x$  the subject.

$$x = 2(y - 2)$$

- 8) Rearrange  $y = \frac{1}{3}x + 1$  to make  $x$  the subject.

$$x = 3(y - 1)$$

## Forming Formulae and Equations

- 1) The width of a rectangle is  $x$  centimetres.  
The length of the rectangle is  $(x + 5)$  centimetres.

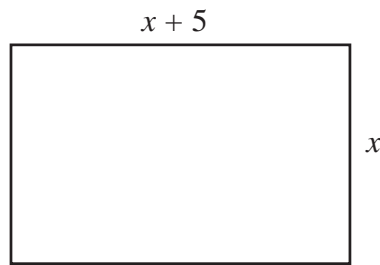

- a) Find an expression, in terms of  $x$ , for the perimeter of the rectangle.  
Give your answer in its simplest form.  $4x + 10$

The perimeter of the rectangle is 38 centimetres.

- b) Work out the length of the rectangle.  $12 \text{ cm}$



2)

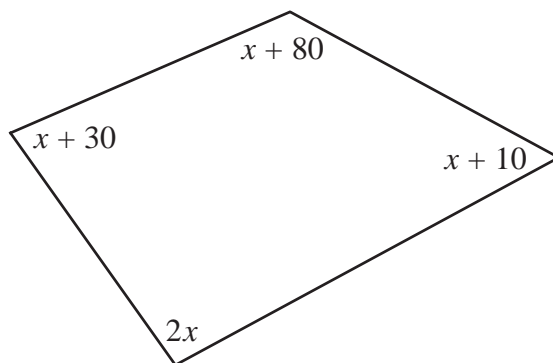

*Diagram NOT accurately drawn*

The sizes of the angles, in degrees, of the quadrilateral are

$x + 10$   
 $2x$   
 $x + 80$   
 $x + 30$

- a) Use this information to write down an equation in terms of  $x$ .  $5x + 120 = 360$
- b) Use your answer to part (a) to work out the size of the smallest angle of the quadrilateral.  $58^\circ$



3) Sarah buys 6 cups and 6 mugs

A cup costs  $\text{£}x$

A mug costs  $\text{£}(x + 3)$

- a) Write down an expression, in terms of  $x$ , for the total cost, in pounds, of 6 cups and 6 mugs.  $12x + 18$
- b) If the total cost of 6 cups and 6 mugs is  $\text{£}48$ , write an equation in terms of  $x$ .  $12x + 18 = 48$
- c) Solve your equation to find the cost of a cup and the cost of a mug.  
**Cup:  $\text{£}2.50$ , Mug:  $\text{£}5.50$**



## Forming Formulae and Equations

1)

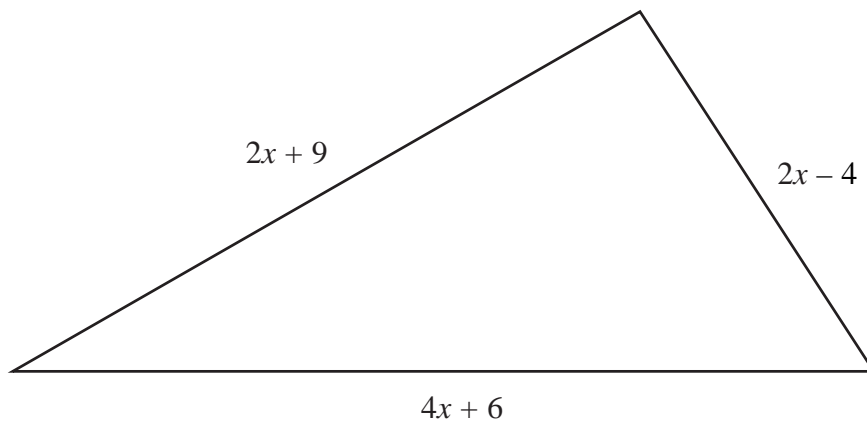

In the diagram, all measurements are in centimetres.

The lengths of the sides are

$$2x + 9$$

$$2x - 4$$

$$4x + 6$$

- a) Find an expression, in terms of  $x$ , for the perimeter of the triangle.  
Give your expression in its simplest form.  $8x + 11$

The perimeter of the triangle is 39 cm.

- b) Find the value of  $x$ .  $3.5$



- 2) The diagram shows a right-angled triangle and a rectangle.

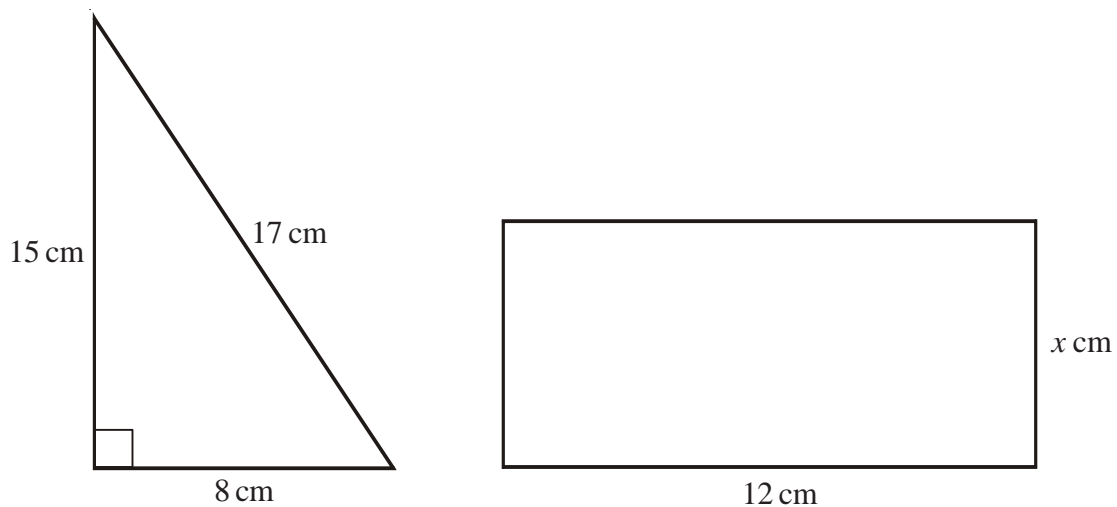

The area of the right-angled triangle is equal to the area of the rectangle.

Find the value of  $x$ .  $5$

- 1) A shop sells small boxes and large boxes for storing CDs.

A small box stores  $x$  CDs.

A large box stores  $y$  CDs.

Emma buys 8 small boxes and 5 large boxes.

Emma can store a total of  $T$  CDs in these boxes.

Write down a formula for  $T$  in terms of  $x$  and  $y$ .  $T = 8x + 5y$

- 2) Batteries are sold in packets and boxes.

Each packet contains 4 batteries.

Each box contains 20 batteries.

Tony buys  $p$  packets of batteries and  $b$  boxes of batteries.

Tony buys a total of  $N$  batteries.

Write down a formula for  $N$  in terms of  $p$  and  $b$ .  $N = 4p + 20b$

- 3) Compasses cost  $c$  pence each.

Rulers cost  $r$  pence each.

Write down an expression for the total cost, in pence, of 2 compasses and 4 rulers.  $2c + 4r$



- 4)

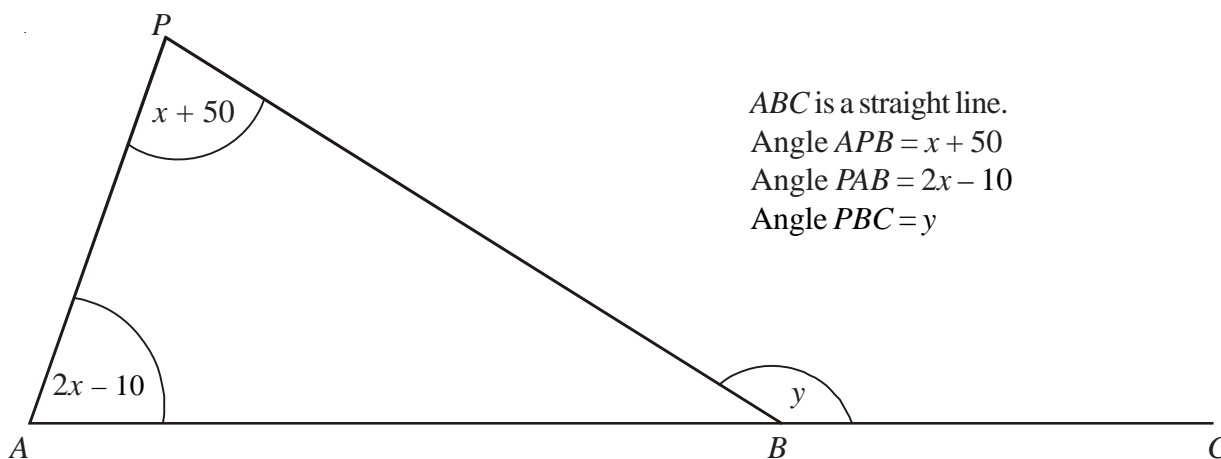

$ABC$  is a straight line.  
Angle  $APB = x + 50$   
Angle  $PAB = 2x - 10$   
Angle  $PBC = y$

$$\begin{aligned} \text{Angle } PAB + \text{Angle } APB &= 3x + 40 \\ \text{Angle } PBA &= 180 - (3x + 40) \\ &= 140 - 3x \\ \text{Angle } y &= 180 - \text{angle } PBA \\ &= 180 - (140 - 3x) \\ &= 40 + 3x \\ &= 3x + 40 \end{aligned}$$

- a) Show that  $y = 3x + 40$   
Give reasons for each stage of your working.

- b) Given that  $y$  equals 145 degrees

(i) Work out the value of  $x$ .  $35^\circ$

(ii) Work out the size of the largest angle in triangle  $APB$ .  $85^\circ$

## Inequalities on a Number Line

- 1) Represent this inequality on the number line

$$-3 < x \leq 2$$

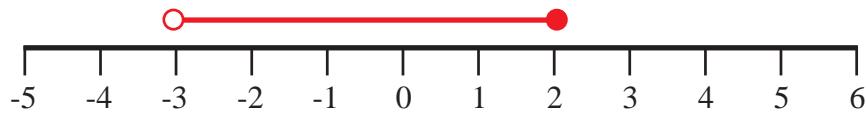

- 2) Represent this inequality on the number line

$$-1 < x < 5$$

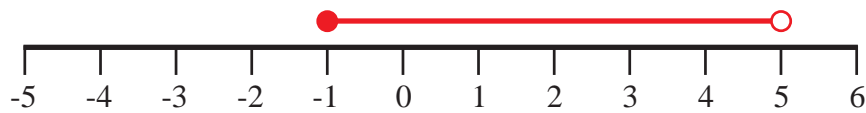

- 3) Write down the inequality shown  $-4 < x \leq 4$

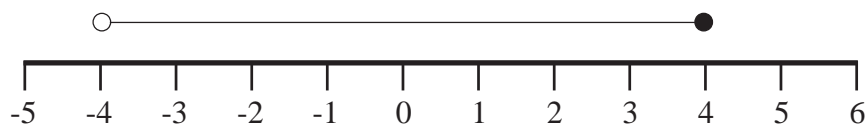

- 4) Write down the inequality shown  $-5 \leq x \leq 3$

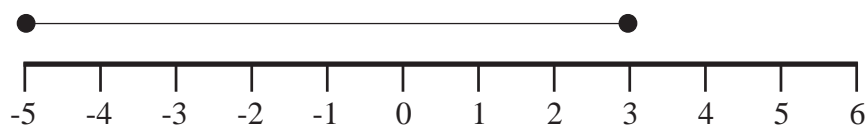

- 5) If  $y$  is an integer, write down all the possible values of

$$-2 < y < 5$$

$-1, 0, 1, 2, 3, 4, 5$

- 6) If  $x$  is an integer, write down all the possible values of

$$-9 < x < -5$$

$-8, -7, -6$

## Solving Linear Inequalities

1) Solve

a)  $3x - 1 > 5$

$x > 2$

b)  $7y + 2 \leq 30$

$y \leq 4$

c)  $\frac{x}{2} - 3 \geq 2$

$x \geq 10$

d)  $5 + 2x > 7$

$x > 1$

e)  $8 < 5p - 2$

$2 < p$

f)  $\frac{y}{3} + 5 \geq 3$

$y \geq -6$

g)  $\frac{2x}{3} - 5 \geq -3$

$x \geq 3$

h)  $6x - 5 > 2x + 3$

$x > 2$

i)  $3p - 9 < 6 - 2p$

$p < 3$

j)  $5 - 3y < 2y - 10$

$3 < y$

2) a) Solve the inequality

$2z + 2 \geq 7$

$z \geq 2.5$

b) Write down the smallest **integer** value of  $z$  which satisfies the inequality

$2z + 2 \geq 7$

$z = 3$

3)  $5x + 2y < 10$  $x$  and  $y$  are both integers.

Write down two possible pairs of values that satisfy this inequality.

$x = \dots 1 \dots, y = \dots 1 \dots$

and

$x = \dots 1 \dots, y = \dots 2 \dots$

other pairs of values are possible.

## Solving Equations and Linear Inequalities

- 1) Solve the inequality  $6x - 3 < 9$   
 $x < 2$
- 2) Solve  $4x + 1 = 2x + 12$   
 $x = 5.5$
- 3) a) Solve the inequality  $3t + 1 < t + 13$   
 $t < 6$   
b) If  $2t^2 = 72$  find a value of  $t$   
 $t = 6$  (or  $-6$ )
- 4) Solve  $3(x + 2) = 8$   $x = \frac{2}{3}$
- 5) Solve the inequality  $6y > y + 10$   
 $y > 2$
- 6) Solve  $4(2x - 3) = 5x + 7$   $x = 6\frac{1}{3}$
- 7)  $h = 5t^2 + 3$   
Work out the value of  $t$  when  $h = 48$   $t = 3$  or  $-3$
- 8) Solve  $3(2p - 4) = 2p + 12$   
 $p = 6$
- 9) Solve the equation  $4x + 1 = 19$   
 $x = 4.5$
- 10) Solve  $\frac{29 - x}{3} = x + 5$   $x = 3.5$
- 11) Solve  $3x - 10 = x + 30$   $x = 20$
- 12) Solve the inequality  $3x - 2 > x + 7$   $x > 4.5$
- 13) Solve the inequality  $\frac{2x}{3} < 10$   $x < 15$

## Simultaneous Equations Graphically

- 1) On the axes below, the graphs of  $y = x + 2$  and  $y = 6 - x$  have been drawn.

Use the graphs to solve the simultaneous equations  $y = x + 2$  and  $y = 6 - x$   $x = 2$   
 $y = 4$

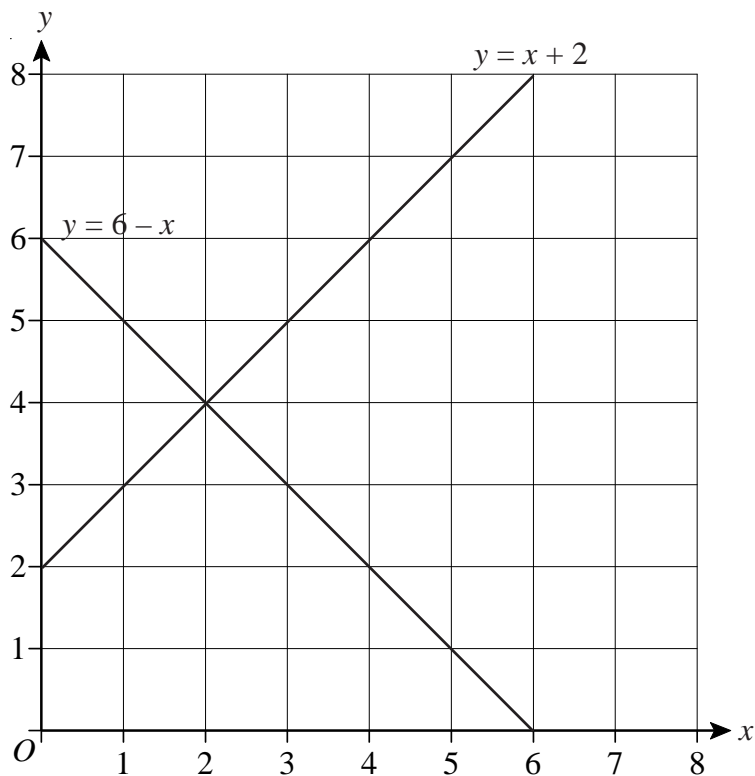

- 2) On the axes below draw the graphs of  $y = 2x + 1$  and  $y = 7 - x$

Use your graphs to solve the simultaneous equations  $y = 2x + 1$  and  $y = 7 - x$

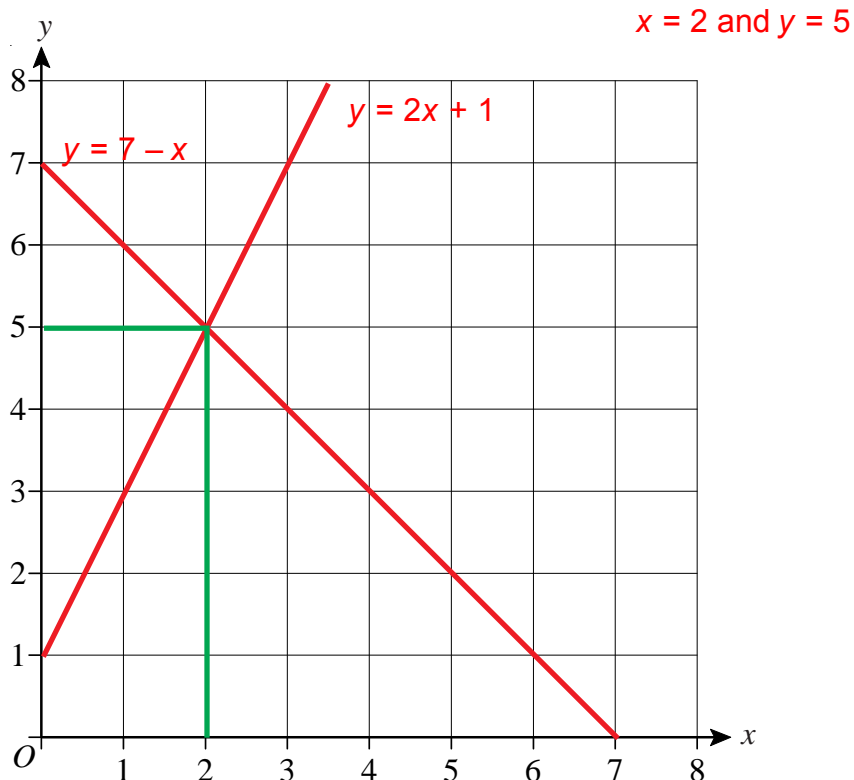

## Fibonacci Sequences

- 1) Write down the next two terms of the Fibonacci sequence that begins

1, 1, 2, 3, 5, 8, 13, ... **21, 34**

- 2) If the first three Fibonacci numbers are  $x_1 = 1, x_2 = 1, x_3 = 2,$

what is the least value of  $n$  for which  $x_n > 60$ ? **11**

- 3) If the first three Fibonacci numbers are  $x_1 = 1, x_2 = 1, x_3 = 2,$

what is the value of  $n$  for which  $x_n + x_{n+1} = 89$ ? **9**

- 4) If the first three Fibonacci numbers are  $x_1 = 1, x_2 = 1, x_3 = 2,$

what is the value of  $n$  for which  $x_n + x_{n+1} + x_{n+2} = 68$ ? **7**

- 5) If the first three Fibonacci numbers are  $x_1 = 1, x_2 = 1, x_3 = 2,$

what is the value of  $n$  for which  $x_{n-1} + x_n = 144$ ? **11**

- 6) If the first three Fibonacci numbers are  $x_1 = 1, x_2 = 1, x_3 = 2,$

what is the least value of  $n$  for which  $\frac{x_{n+1}}{x_n} = 1.619$  correct to three decimal places? **8**



- 1) Jane runs 200 metres in 21.4 seconds.

Work out Jane's average speed in metres per second.  
Give your answer correct to 1 decimal place.

$$S = 9.3 \text{ m/s}$$



- 2) A car travels at a steady speed and takes five hours to travel 310 miles.

Work out the average speed of the car in miles per hour.

$$S = 62 \text{ mph}$$



- 3) A plane flies 1440 miles at a speed of 240 mph.

How long does it take?

$$T = 6 \text{ hours}$$



- 4) A marathon runner runs at 7.6 mph for three and a half hours.

How many miles has he run?

$$D = 26.6 \text{ miles}$$



- 5) A car takes 15 minutes to travel 24 miles.

Find its speed in **mph**.

$$S = 96 \text{ mph}$$



- 6) A cyclist takes 10 minutes to travel 2.4 miles.

Calculate the average speed in mph.

$$S = 14.4 \text{ mph}$$



- 7) An ice hockey puck has a volume of  $113 \text{ cm}^3$ .

It is made out of rubber with a density of 1.5 grams per  $\text{cm}^3$ .

Work out the mass of the ice hockey puck.

$$M = 169.5 \text{ g}$$



- 8) An apple has a mass of 160 g and a volume of  $100 \text{ cm}^3$ .

Find its density in  $\text{g/cm}^3$ .

$$D = 1.6 \text{ g/cm}^3$$



- 9) A steel ball has a volume of  $1500 \text{ cm}^3$ .

The density of the ball is  $95 \text{ g/cm}^3$ .

Find the mass of the ball **in kg**.

$$M = 142.5 \text{ kg}$$



- 10) The mass of a bar of chocolate is 1800 g.

The density of the chocolate is  $9 \text{ g/cm}^3$ .

What is the volume of the bar of chocolate?

$$V = 200 \text{ cm}^3$$





- 1) Tony went on holiday to Miami.  
He travelled from London by plane.  
The distance from London to Miami is 7120 km.  
The plane journey took 8 hours.

Calculate the average speed of the plane. **890 km/h**



- 2) A solid cylinder has a radius of 4 cm and a height of 10 cm.

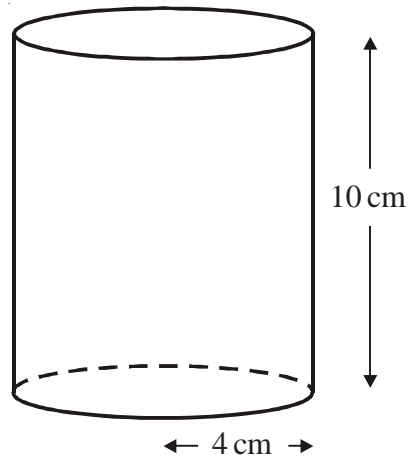

- a) Work out the volume of the cylinder.  
Give your answer correct to 3 significant figures. **503 cm<sup>3</sup>**

The cylinder is made of wood.  
The density of the wood is 0.7 grams per cm<sup>3</sup>

- b) Work out the mass of the cylinder.  
Give your answer correct to 3 significant figures. **352 g**

3)

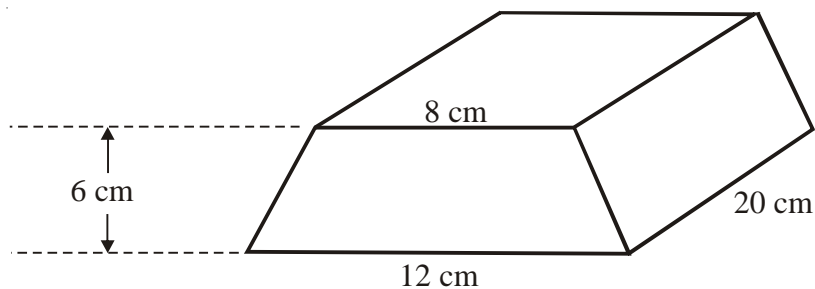

The diagram shows a solid prism made from metal.  
The cross-section of the prism is a trapezium.

The parallel sides of the trapezium are 8 cm and 12 cm.  
The height of the trapezium is 6 cm.  
The length of the prism is 20 cm.

The density of the metal is 4 g/cm<sup>3</sup>.

Calculate the mass of the prism. **4.8 kg**  
Give your answer in kilograms.

## Distance-Time Graphs

- 1) Sarah travelled 20 km from home to her friend's house. She stayed at her friend's house for some time before returning home. Here is the travel graph for part of Sarah's journey.

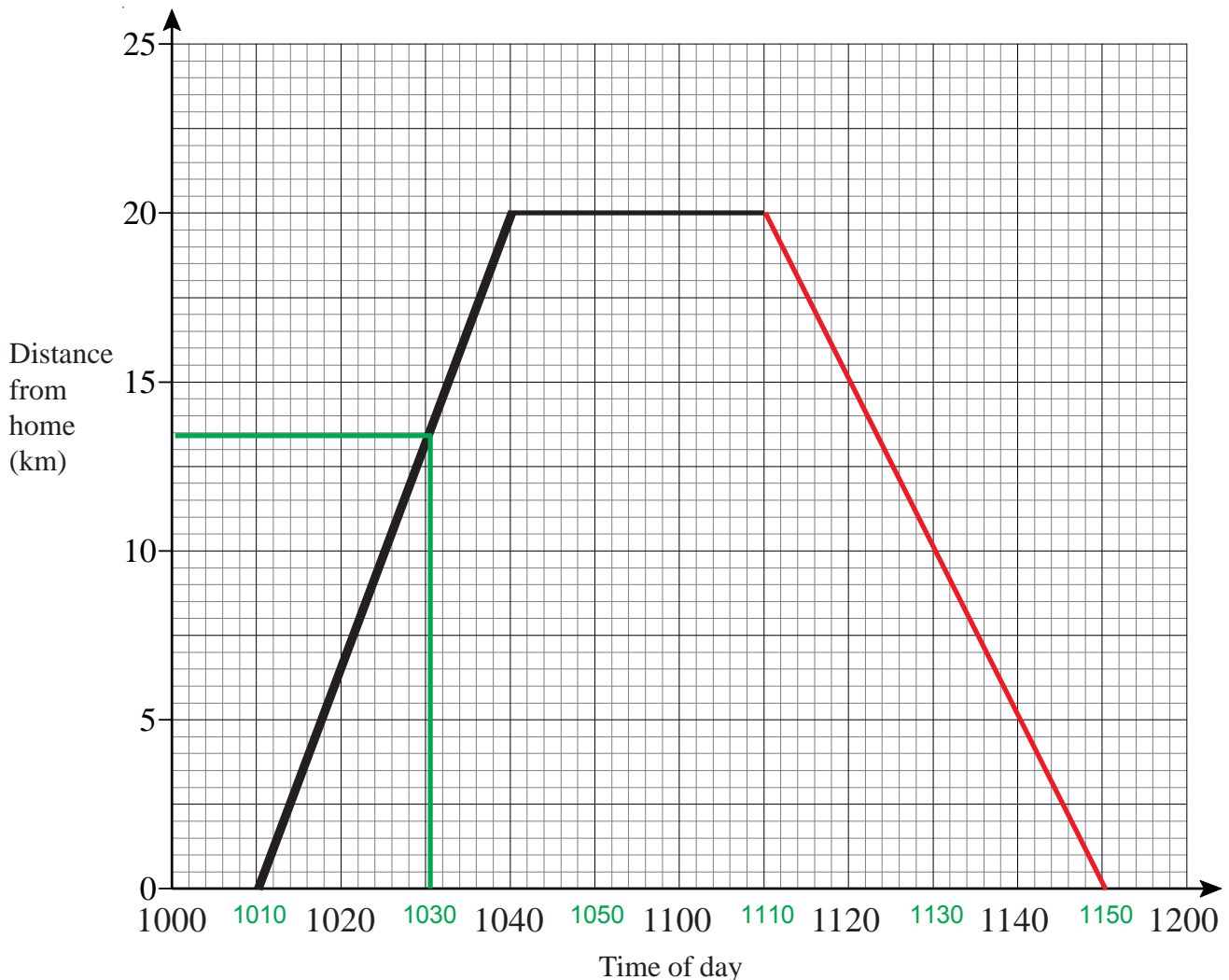

a) At what time did Sarah leave home? **10 10**

b) How far was Sarah from home at 10 30? **13.5 km**

Sarah left her friend's house at 11 10 to return home.

c) Work out the time in minutes Sarah spent at her friend's house. **30 minutes**

Sarah returned home at a steady speed.

She arrived home at 11 50

d) Complete the travel graph.

e) Work out Sarah's average speed on her journey from her home to her friend's house. Give your answer in kilometres per hour. **40 km/h**

f) Work out Sarah's average speed on her journey home from her friend's house. Give your answer in kilometres per hour. **30 km/h**

## Similar Shapes



1)

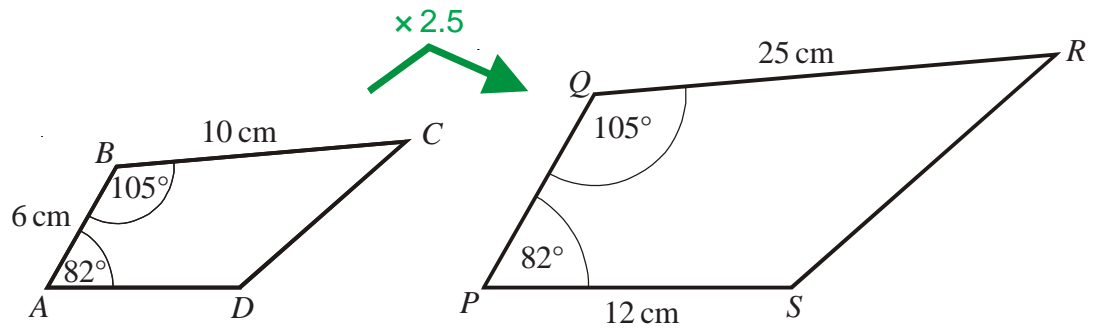

$ABCD$  and  $PQRS$  are mathematically similar.

- Find the length of  $PQ$ . **15 cm**
- Find the length of  $AD$ . **4.8 cm**



2)

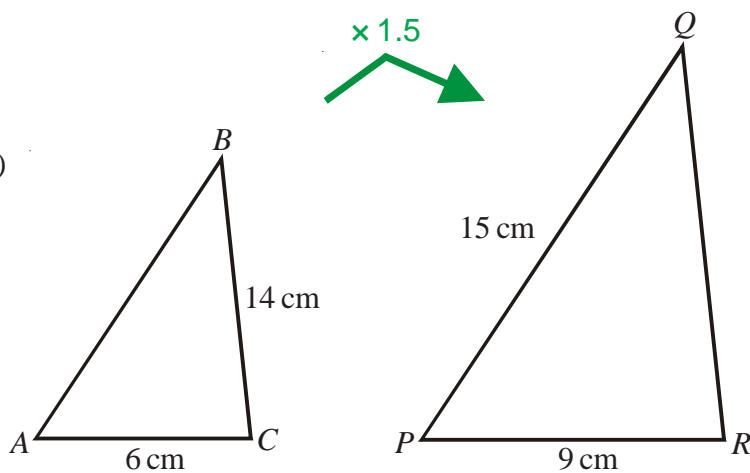

Triangles  $ABC$  and  $PQR$  are mathematically similar.

Angle  $A$  = angle  $P$ .

Angle  $B$  = angle  $Q$ .

Angle  $C$  = angle  $R$ .

$AC$  = 6 cm.

$BC$  = 14 cm.

$PR$  = 9 cm.

$PQ$  = 15 cm

- Work out the length of  $QR$ . **21 cm**
- Work out the length of  $AB$ . **10 cm**



1)

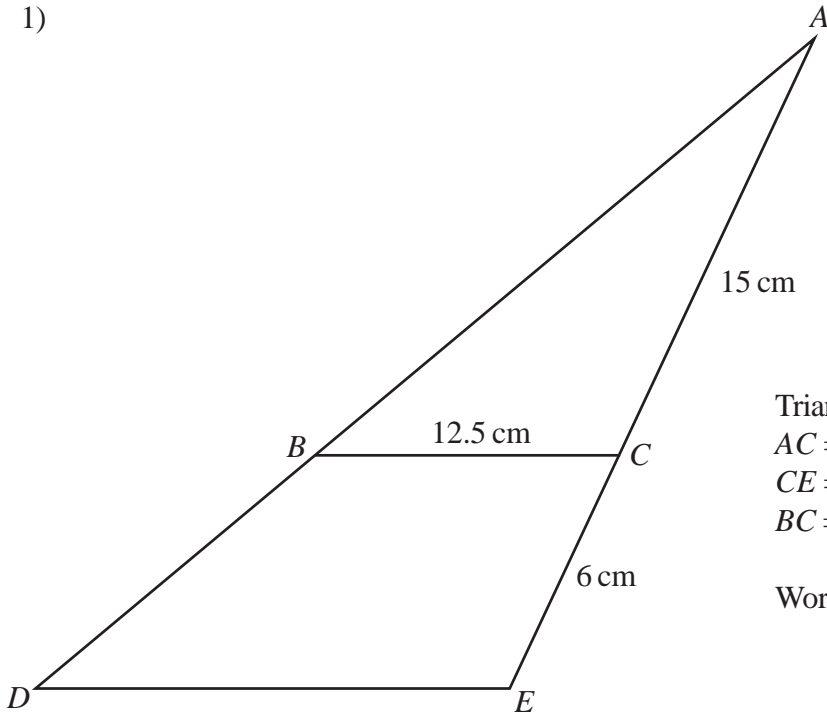

Triangle  $ABC$  is similar to triangle  $ADE$ .  
 $AC = 15$  cm.  
 $CE = 6$  cm.  
 $BC = 12.5$  cm.

Work out the length of  $DE$ . **17.5 cm**



- 2)  $ABC$  and  $AED$  are straight lines.  
 $EB$  is parallel to  $DC$ .  
 Angle  $ACD = 90^\circ$

$AB = 10$  cm  
 $BC = 5$  cm  
 $EB = 6$  cm

- a) Work out the length of  $DC$ . **9 cm**
- b) Work out the area of the trapezium  $EBCD$ .  **$37.5 \text{ cm}^2$**

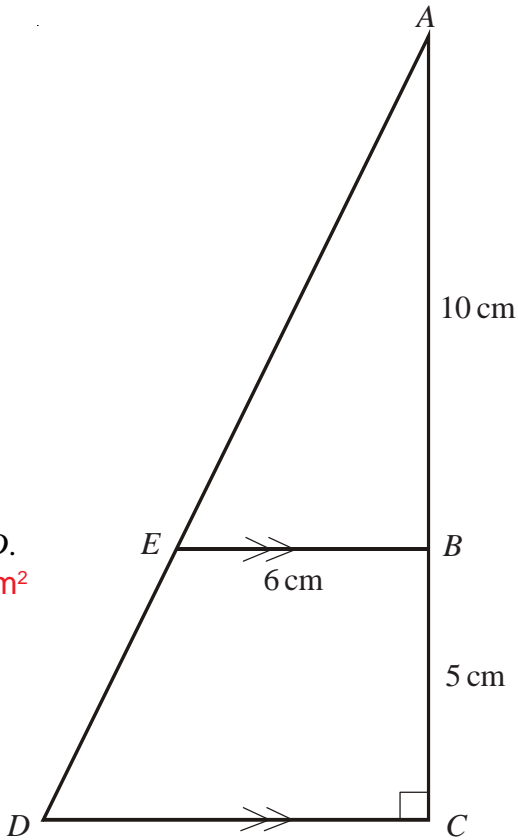

## Similar Shapes

- 1) The diagram shows two quadrilaterals that are mathematically **similar**.

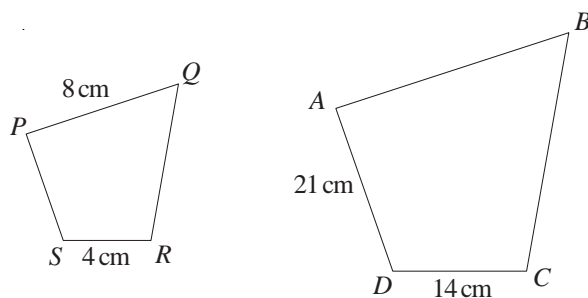

a) Calculate the length of  $AB$  **28 cm**

b) Calculate the length of  $PS$  **6 cm**



- 2)  $SV$  is parallel to  $TU$ .  
 $RST$  and  $RVU$  are straight lines.  
 $RS = 9$  cm,  $ST = 3$  cm,  $TU = 7$  cm,  $RV = 6$  cm

Calculate the length of  $VU$ . **2 cm**

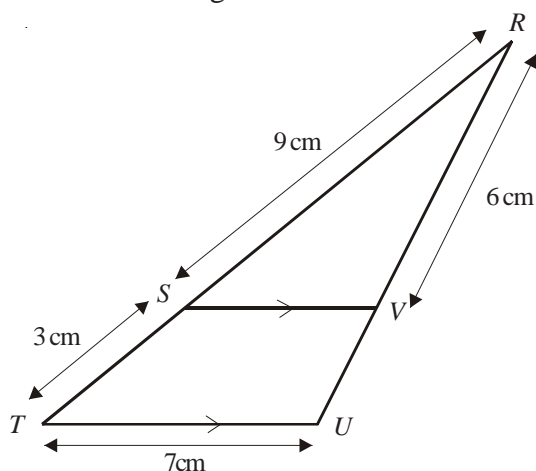

- 3)  $BE$  is parallel to  $CD$ .  
 $ABC$  and  $AED$  are straight lines.  
 $AB = 4$  cm,  $BC = 6$  cm,  $BE = 5$  cm,  $AE = 4.4$  cm

a) Calculate the length of  $CD$ . **12.5 cm**

b) Calculate the length of  $ED$ . **6.6 cm**

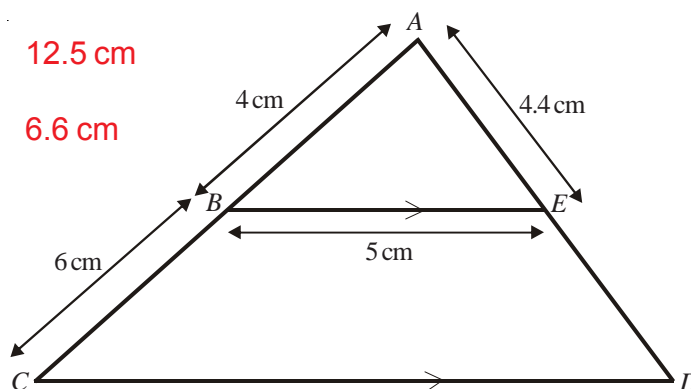

## Bisecting an Angle

- 1) Using ruler and compasses, bisect angle  $ABC$ .

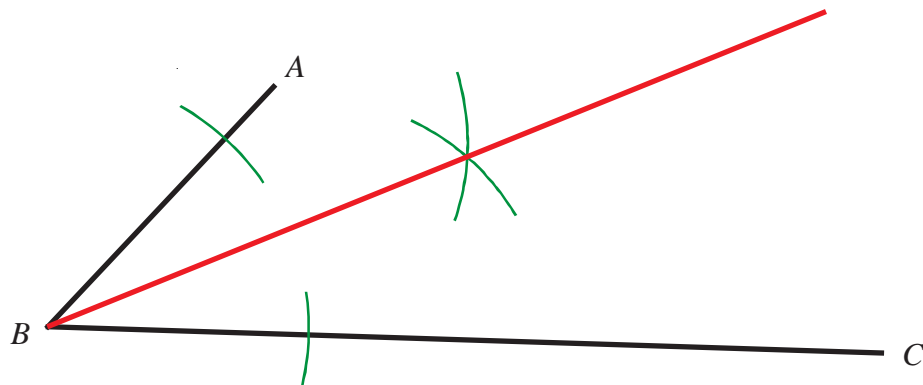

- 2) The diagram below shows the plan of a park.  
 The border of the park is shown by the quadrilateral  $RSTUV$

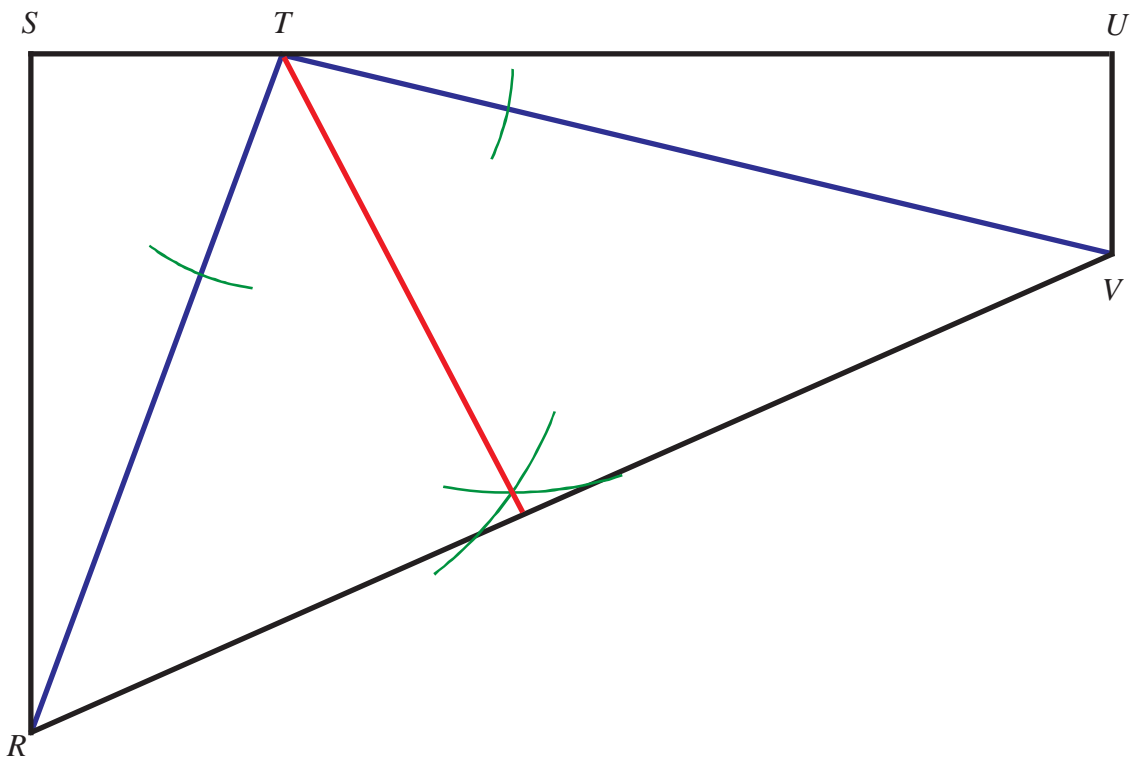

There are two paths in the park. One is labelled  $TR$  and the other  $TV$   
 A man walks in the park so that he is always the same distance from both paths.  
 Using ruler and compasses show exactly where the man can walk.

## Constructing Perpendiculars

- 1) Use ruler and compasses to bisect the line segment  $AB$ .  
You must show all construction lines.

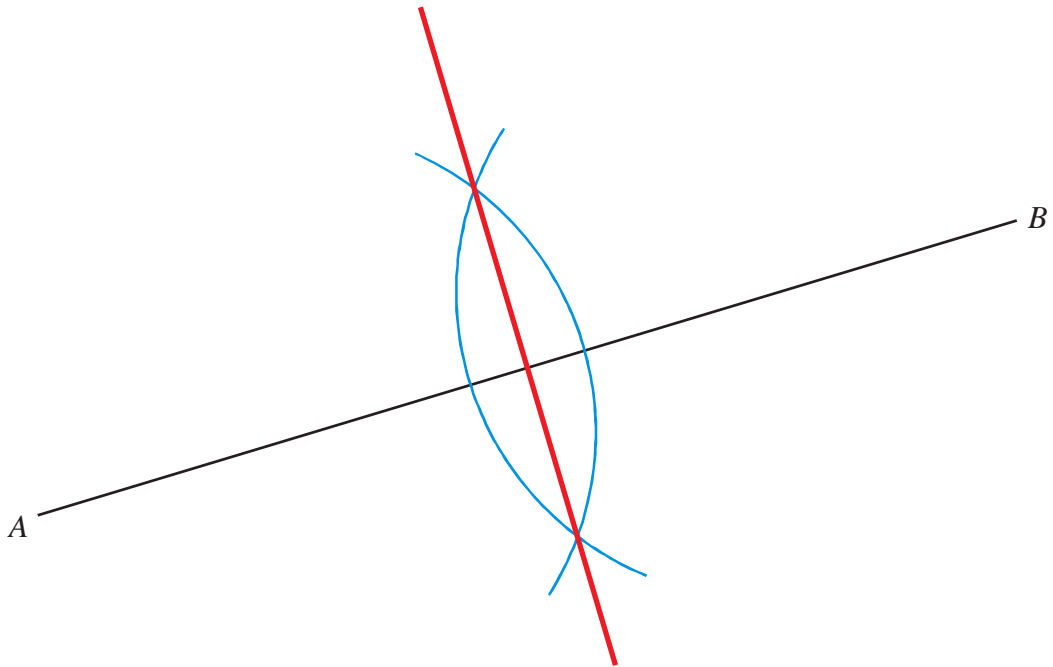

- 2) Use ruler and compasses to **construct** the perpendicular to the line segment  $CD$  that passes through the point  $P$ .  
You must show all construction lines.

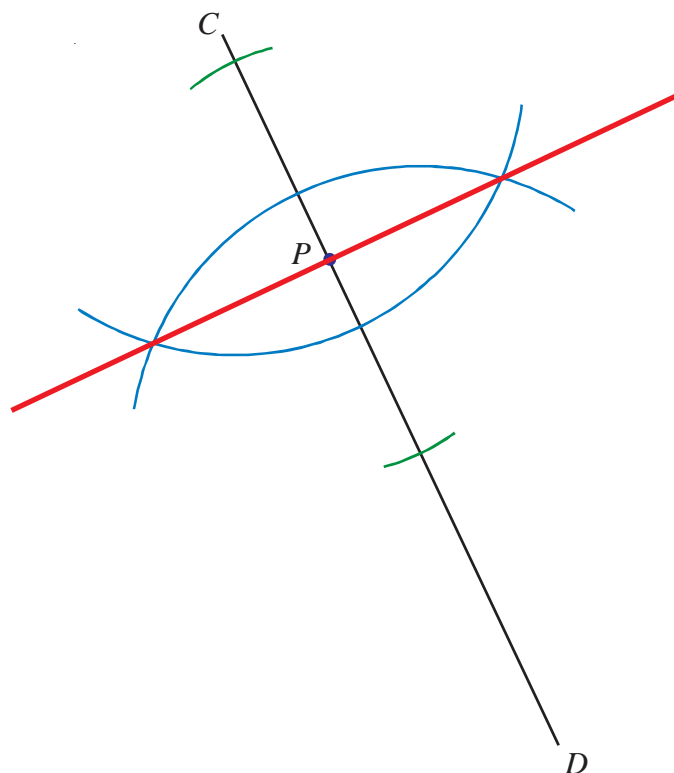

## Drawing a Triangle Using Compasses

- 1) The diagram shows a sketch of triangle  $ABC$ .

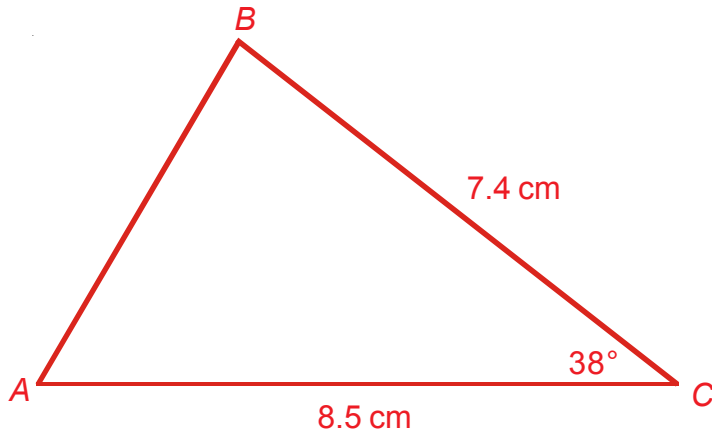

$BC = 7.4\text{ cm}$   
 $AC = 8.5\text{ cm}$   
 Angle  $C = 38^\circ$

- a) Make an accurate drawing of triangle  $ABC$ .  
 b) Measure the size of angle  $A$  on your diagram. Angle  $A = 59^\circ$

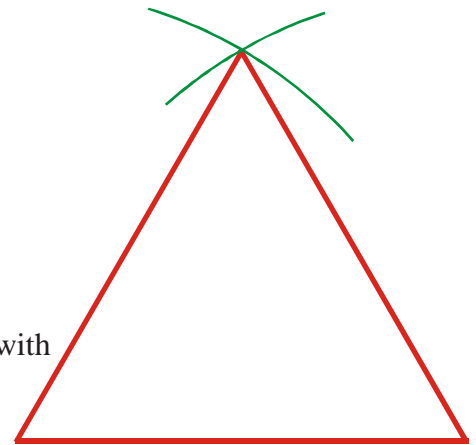

- 2) Use ruler and compasses to **construct** an equilateral triangle with sides of length 6 centimetres. You must show all construction lines.

- 3) The diagram shows a sketch of triangle  $PQR$ .

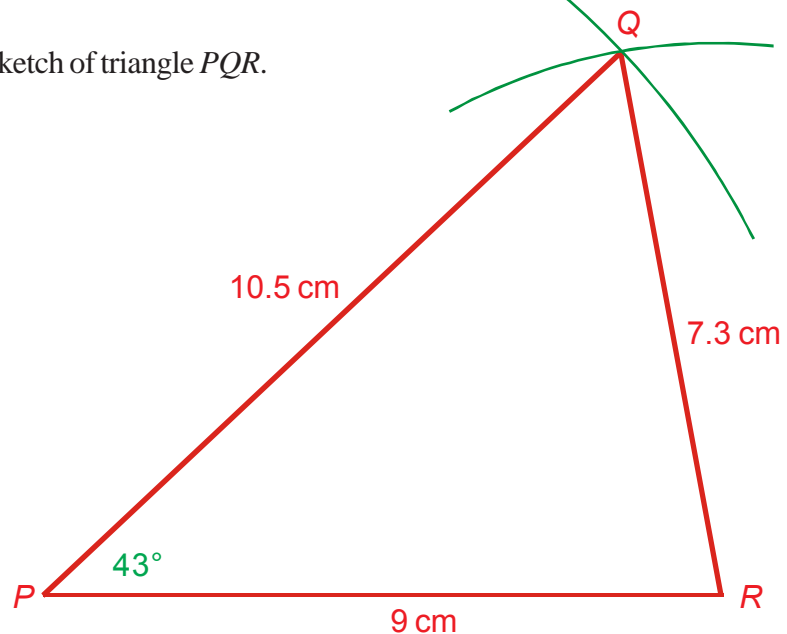

- a) Use ruler and compasses to make an accurate drawing of triangle  $PQR$ .  
 b) Measure angle  $P$ . Angle  $P = 43^\circ$



## Enlargements

- 1) a) Enlarge triangle T by scale factor 2 using point  $(-5, 2)$  as the centre of enlargement. Label your new triangle U.
- b) Enlarge triangle V by scale factor a half using the point  $(-2, -3)$  as the centre of enlargement. Label your new triangle W.

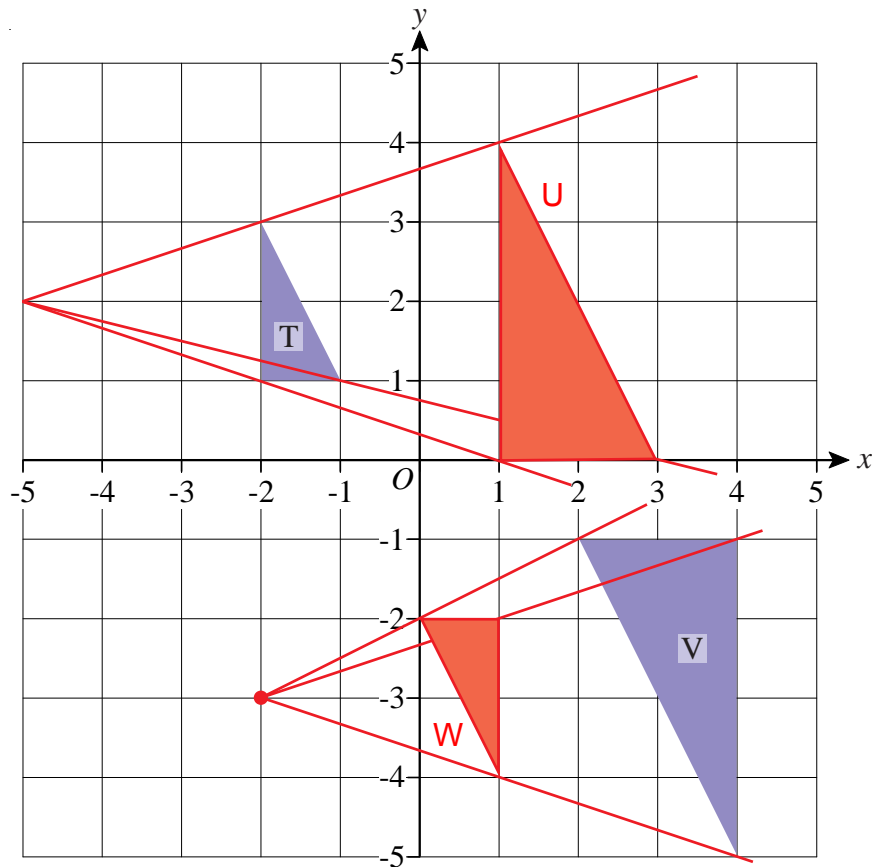

- 2) Describe fully the single transformation which maps triangle S to triangle T.  
**Enlargement, scale factor 3, centre of enlargement  $(0, 3)$ .**

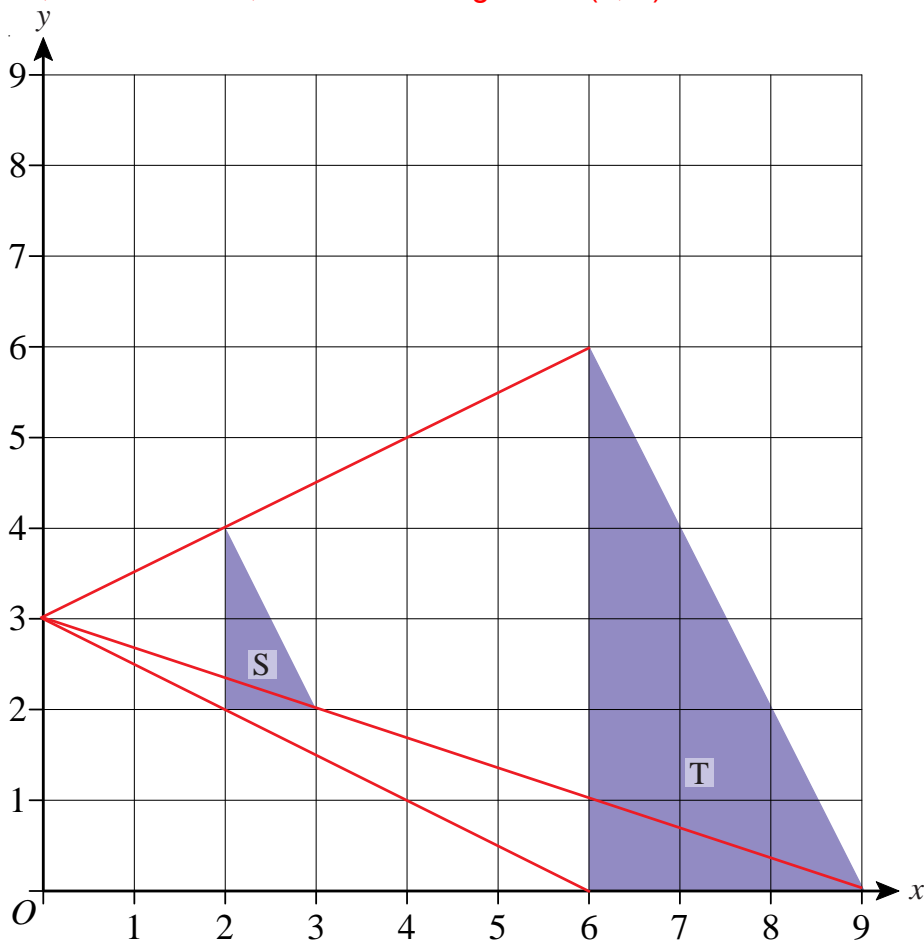

## Tangents, Arcs, Sectors and Segments

Tangent
Radius
Minor sector
Minor segment
Arc
Diameter
Chord
Circumference

On the diagram, mark on all of the words from the box in an appropriate place.

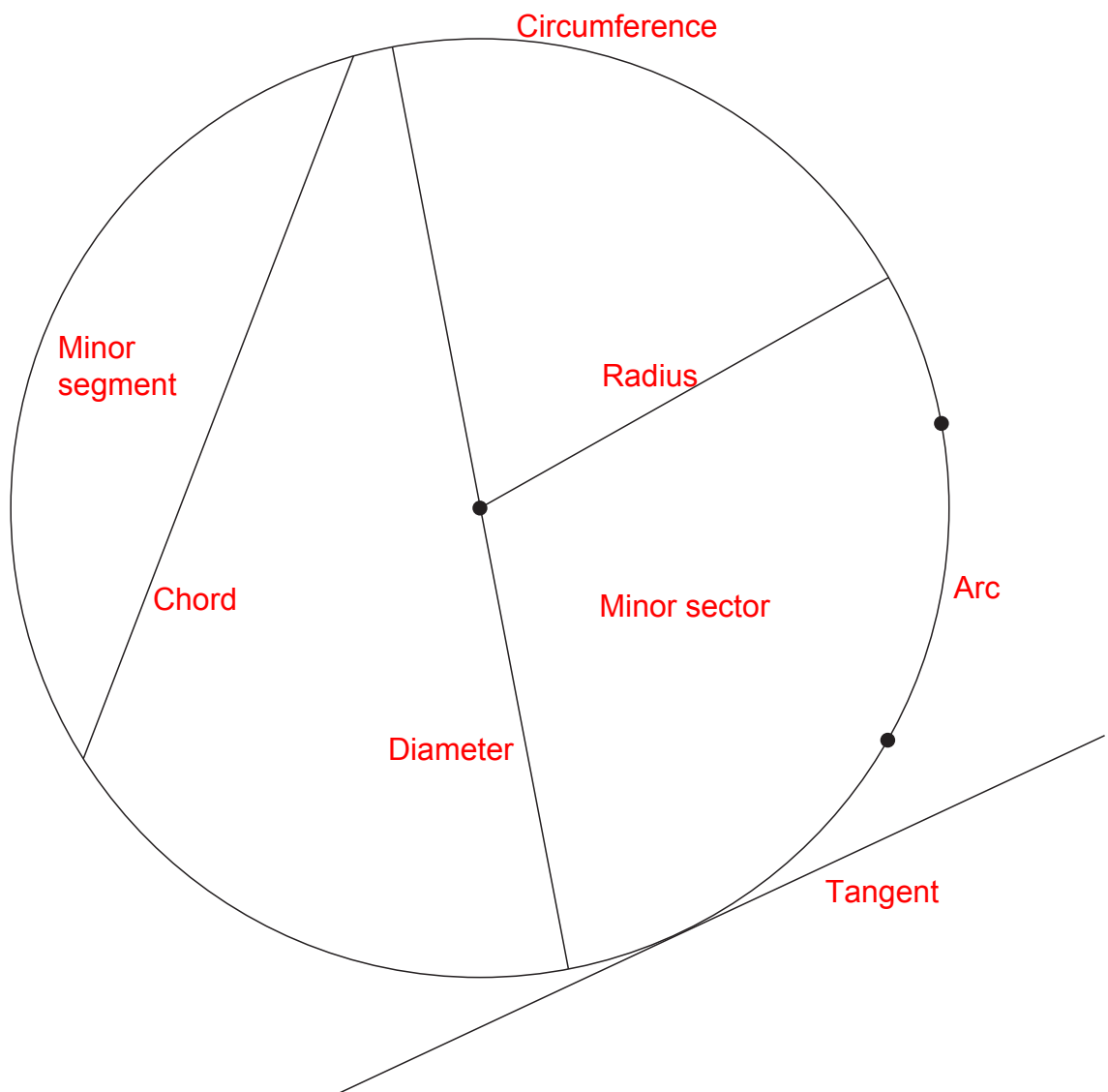

## Pythagoras' Theorem



- 1) Find the length of side  $a$ .  
Give your answer to 1 decimal place.

**18.4 cm**

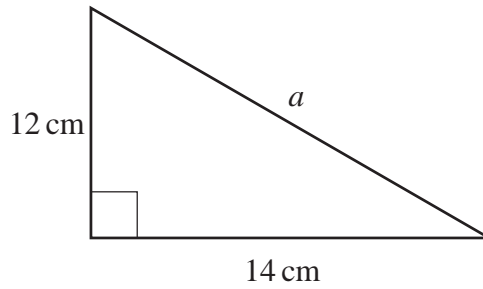

- 2) Find the length of side  $b$ .  
Give your answer to 1 decimal place.

**9.4 cm**

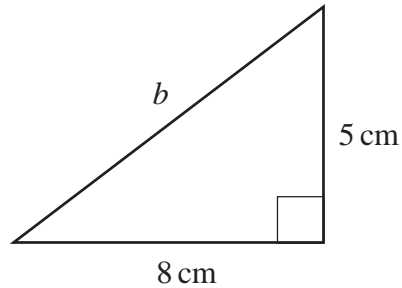

- 3) Find the length of side  $c$ .  
Give your answer to 1 decimal place.

**8.3 cm**

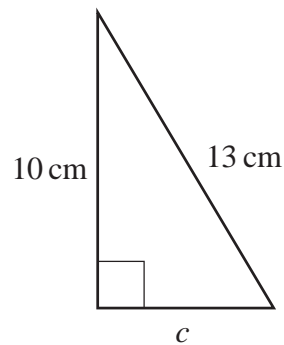

- 4) Find the length of side  $d$ .  
Give your answer to 1 decimal place.

**6.2 cm**

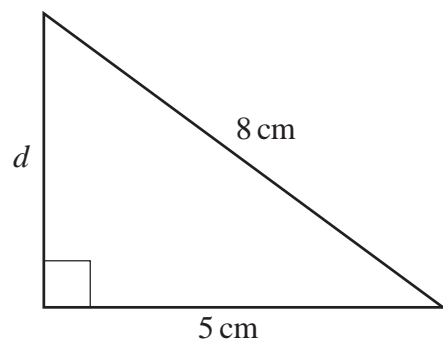

- 5) Find the length of the diagonal of this rectangle.  
Give your answer to 1 decimal place.

**18.4 cm**

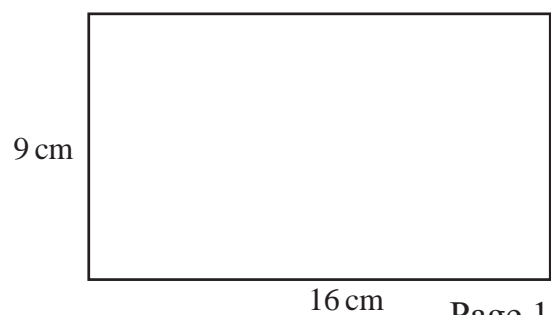

16 cm

## Pythagoras' Theorem



- 1) Find the length of side  $AC$ .  
Give your answer to 1 decimal place.

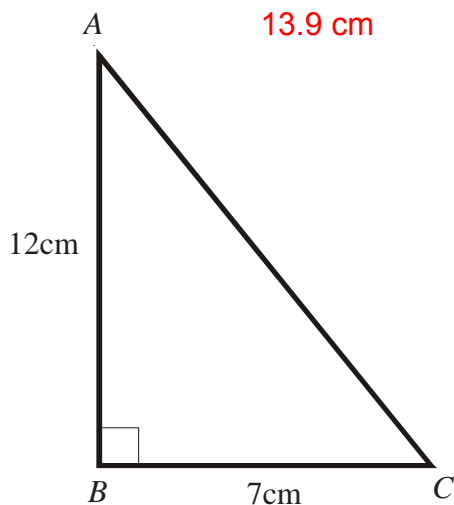

- 2) Find the length of side  $QR$   $5.9\text{ cm}$ .  
Give your answer to 1 decimal place.

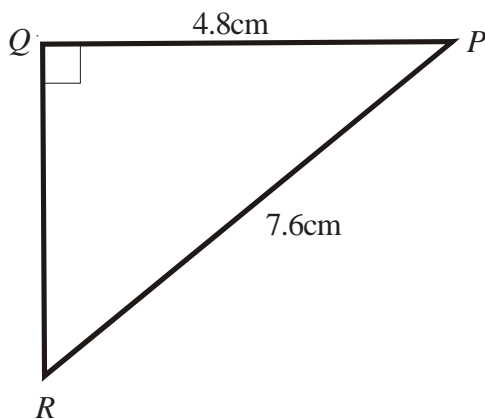

- 3) Find the length of side  $SU$ .  
Give your answer to 1 decimal place.

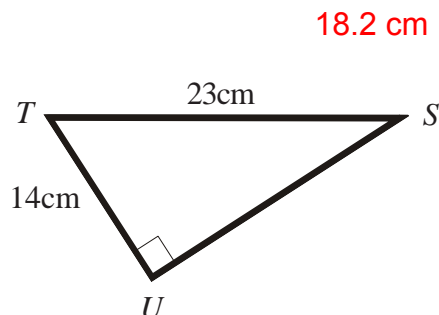

- 4) Below is a picture of a doorway.  
Find the size of the diagonal of the doorway.  
Give your answer to 1 decimal place.

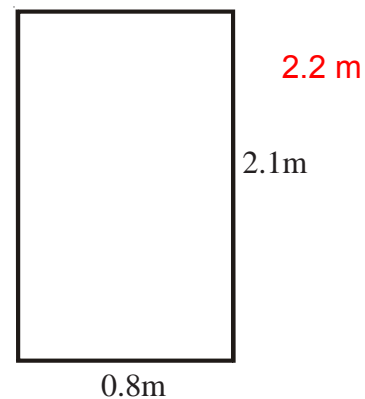

- 5) In the sketch of the rectangular field, below,  
James wants to walk from  $B$  to  $D$ .

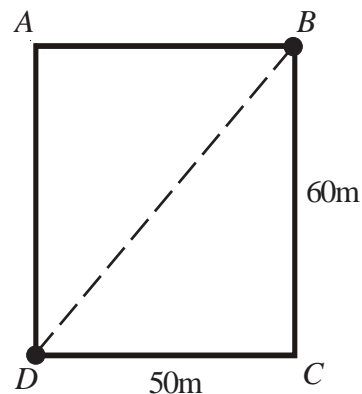

Which of the following routes is shorter and by how much?

From  $B$  to  $C$  to  $D$  or straight across the field from  $B$  to  $D$ .  $B$  to  $D$  is shorter, by  $32\text{ m}$ .  
Give your answer to the nearest metre.



- 6) Fiona keeps her pencils in a cylindrical beaker as shown below.  
The beaker has a diameter of  $8\text{cm}$  and a height of  $17\text{cm}$ .  
Will a pencil of length  $19\text{cm}$  fit in the beaker without poking out of the top? **No. The diagonal is only  $18.8\text{cm}$ .**  
All workings must be shown.

Longest side

$$17^2 = 289$$

$$8^2 = \frac{64}{353}$$

$$\sqrt{353} = 18.79$$

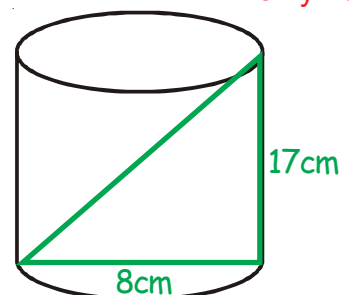



- 1) Points  $P$  and  $Q$  have coordinates  $(1, 4)$  and  $(5, 2)$ .  
Calculate the shortest distance between  $P$  and  $Q$ .  
Give your answer correct to 1 decimal place. **4.5**

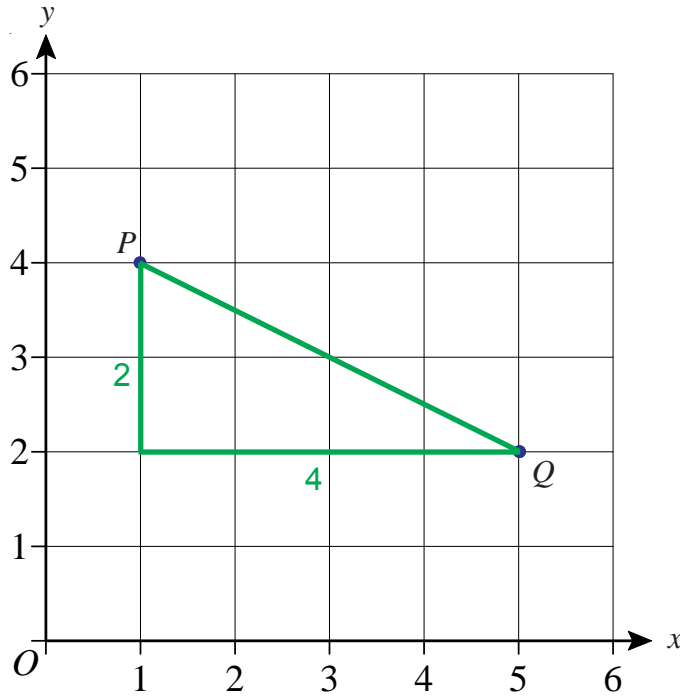

- 2) Points  $A$  and  $B$  have coordinates  $(-4, 3)$  and  $(3, -2)$ .  
Calculate the shortest distance between  $A$  and  $B$ .  
Give your answer correct to 1 decimal place. **8.6**

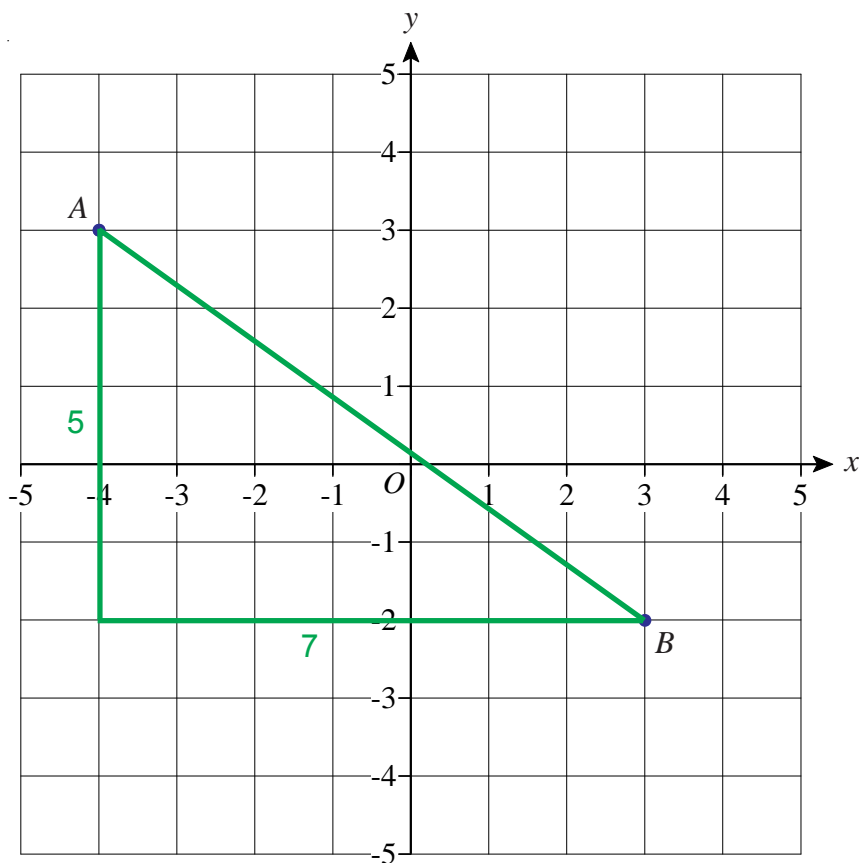

## Simple Tree Diagrams

- 1) Jim and Sue each take a driving test.  
The probability that Jim will pass the driving test is 0.7  
The probability that Sue will pass the driving test is 0.6  
a) Complete the probability tree diagram.

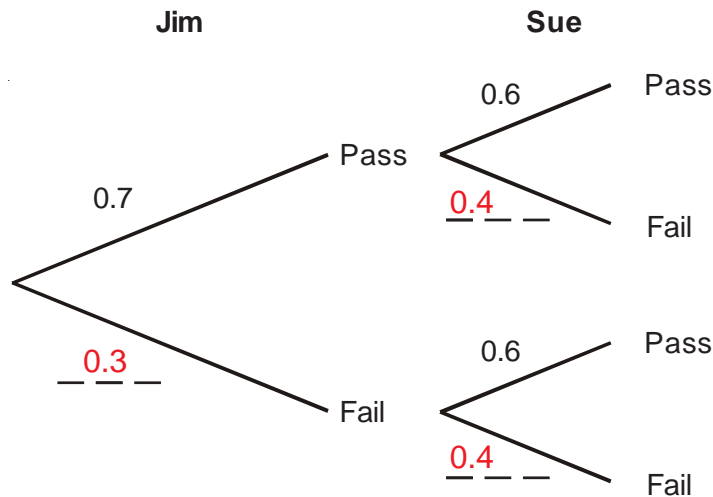

- b) Work out the probability that both Jim and Sue will pass the driving test.  $0.42$   
c) Work out the probability that only one of them will pass the driving test.  $0.28 + 0.18 = 0.46$
- 2) Terri has 7 pens in a box.  
2 of the pens are blue.  
5 of the pens are red.  
Terri takes at random a pen from the box and writes down its colour.  
Terri puts the pen back in the box.  
Then Terri takes at random a second pen from the box and writes down its colour.

- a) Complete the probability tree diagram.

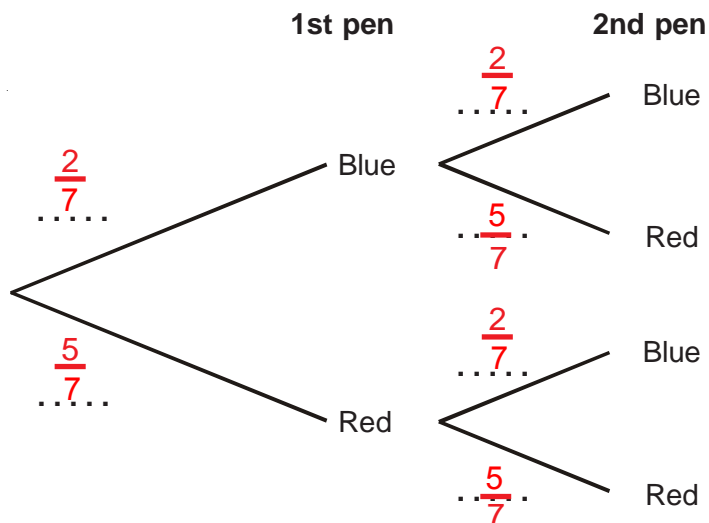

- b) Work out the probability that Terri takes exactly one pen of each colour from the box.

$$\frac{10}{49} + \frac{10}{49} = \frac{20}{49}$$

## Simple Tree Diagrams

- 1) Tim puts 3 red counters and 4 blue counters in a bag.  
 He takes at random a counter from the bag.  
 He writes down the colour of the counter.  
 He puts the counter in the bag again.  
 He then takes at random a second counter from the bag.

- a) Complete the probability tree diagram.

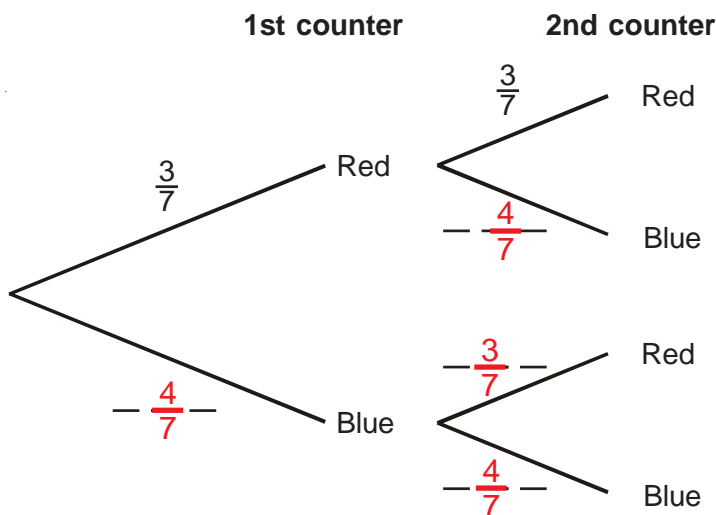

- b) Work out the probability that Tim takes two red counters.  $\frac{9}{49}$



- 2) In a game of chess, a player can either win, lose or draw.  
 The probability that Jane wins any game of chess is 0.2  
 The probability that Jane draws any game of chess is 0.3  
 Jane plays 2 games of chess.

- a) Complete the probability tree diagram.

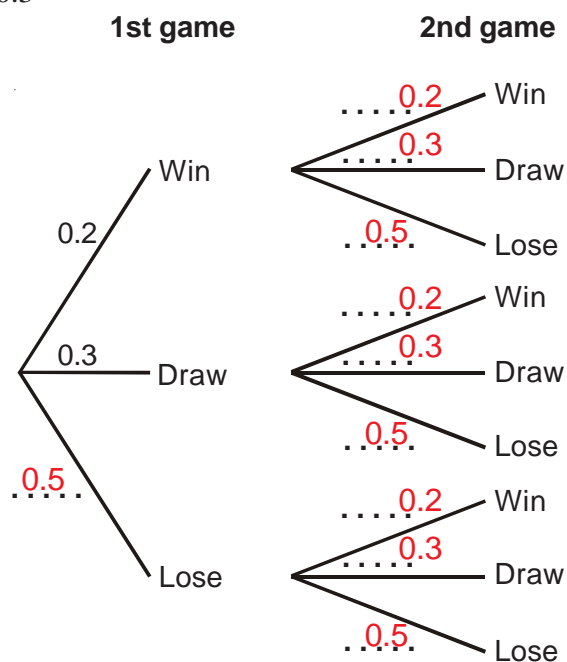

- b) Work out the probability that Jane will win both games.  $0.04$

## Simple Tree Diagrams

- 1) Lucy throws a biased dice twice.

Complete the probability tree diagram to show the outcomes.

Label clearly the branches of the tree diagram.

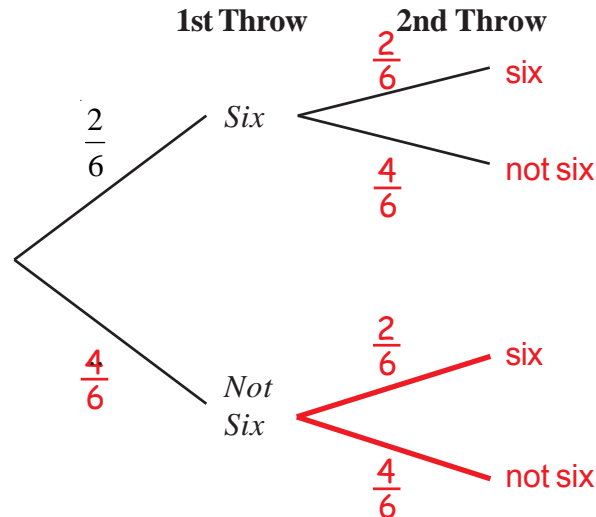

- 2) A bag contains 10 coloured balls.

7 of the balls are blue and 3 of the balls are green.

Nathan is going to take a ball, replace it, and then take a second ball.

- a) Complete the tree diagram.

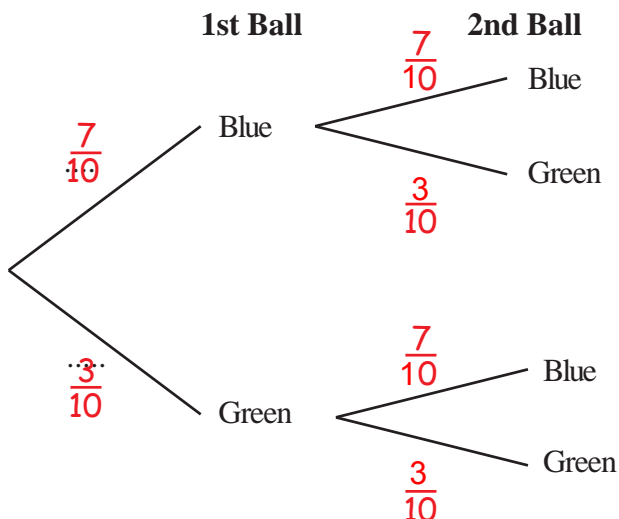

- b) Work out the probability that Nathan will take two blue balls.

$$\frac{49}{100}$$

- c) Work out the probability that Nathan will take one of each coloured balls.

$$\frac{42}{100}$$

- d) Work out the probability that Nathan will take two balls of the same colour.

$$\frac{58}{100}$$



## Sampling Populations

- 1) In a school there were 800 students who regularly had a school dinner.

The Headteacher of the school wanted to know whether the students liked the dinners.

- a) What is the main advantage of asking a sample of the students whether they like school dinners rather than asking all of them? **It is quicker.**
- b) The Headteacher asked 100 KS3 students whether they liked the dinners and 40 of them said they did.

Use this information to estimate how many of the 800 students liked school dinners. **320**

- c) In finding your answer to part b), what assumption have you made? **KS4 students are as likely to like school dinners as KS3 students.**
- d) What could be done to make your estimate more accurate? **Include KS4 students in the sample, as well as KS3 students.**

- 2) A park-keeper wanted to know how many fish there were in the park pond.

He went to the pond early one morning and used his fishing rod to catch 20 fish. The bait he used was maggots.

Then, he marked each of the fish with a white dot on their tail and released them.

A week later, he used his fishing rod and maggots to catch another 20 fish.

He found that 4 of these 20 fish had the white dot on their tails.

- a) Use this information to estimate how many fish there are in the pond. **100**
- b) In finding your estimate, what assumption have you made? **All of the fish are attracted to the specific bait that he is using.**

## Time Series

The table on the right shows the sales figures for a manufacturing company over the course of 15 years.

- Complete the time series graph to show this information.
- What is the range of the sales figures? **£57.5M**
- Comment on the trend over the course of 15 years.  
**The sales are increasing.**

Year	Sales (£M)
2000	10
2001	5
2002	10
2003	25
2004	22.5
2005	50
2006	27.5
2007	15
2008	35
2009	55
2010	50
2011	25
2012	45
2013	62.5
2014	57.5

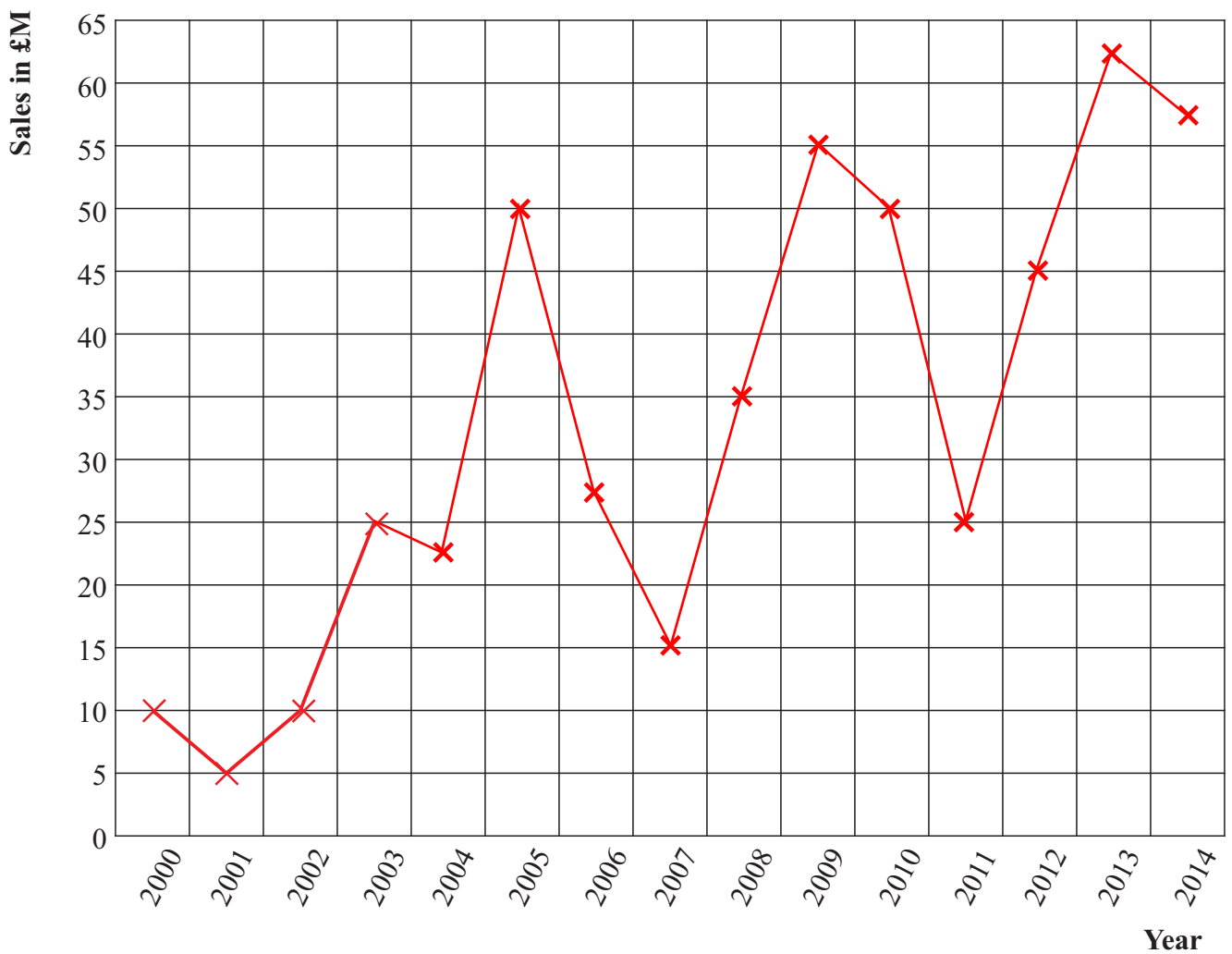

1) Find the value of:

a)  $2^{-3} = \frac{1}{8}$

b)  $3^{-2} = \frac{1}{9}$

c)  $5^{-1} = \frac{1}{5}$

d)  $10^{-4} = \frac{1}{10000}$

2) Find the value of:

a)  $2^{-3} \times 4^{-1} = \frac{1}{32}$

b)  $10^{-2} \times 2^{-4} = \frac{1}{1600}$

c)  $5 \times 5^{-3} = \frac{1}{25}$

d)  $8 \times 2^{-3} = 1$

3) Write these numbers in order of size.

Start with the smallest.

$3^2 \quad 3^{-1} \quad 0.3 \quad 3^0 \quad 3^{-2} \quad -3$

$-3, 3^{-2}, 0.3, 3^{-1}, 3^0, 3^2$

4) If  $2^x = \frac{1}{64}$ , find the value of  $x$ .

$x = -6$

- 1) A number,  $x$ , rounded to 1 decimal place is 4.7

Write down the error interval for  $x$ .  $4.65 \leq x < 4.75$

- 2) A number,  $y$ , rounded to 2 decimal places is 12.36

Write down the error interval for  $y$ .  $12.355 \leq y < 12.365$

- 3) A number,  $x$ , rounded to 1 significant figure is 400.

Write down the error interval for  $x$ .  $350 \leq x < 450$

- 4) A number,  $y$ , rounded to 2 significant figures is 67000.

Write down the error interval for  $y$ .  $66500 \leq y < 67500$

- 5) A number,  $x$ , rounded to 3 significant figures is 24100.

Write down the error interval for  $x$ .  $24050 \leq x < 24150$

- 1) Meg says,

“The sum of three prime numbers is always odd.”

Write an example to show that Meg is incorrect.

$$2 + 3 + 5 = 10$$

Other examples are possible, but one of the chosen prime numbers should be 2.

- 2) Mike says.

“If you cube a prime number, the result will always be odd.”

Give an example to show that Mike is wrong.

$$2^3 = 8$$

- 3) Explain why an odd number plus another odd number plus an even number is always even.

$$\text{odd} + \text{odd} = \text{even}$$

$$\text{even} + \text{even} = \text{even}$$

- 4)  $P$  is an odd number.

$Q$  is an even number.

Explain why  $2P + 2Q - 1$  is always odd.

$$2P = \text{even}$$

$$2Q = \text{even}$$

$$2Q = \text{even}$$

$$2P + 2Q - 1 = \text{odd}$$

- 5)  $P$  is an odd number.

$Q$  is an even number.

Tim says that  $P + Q$  is always a prime number.

Explain why Tim is wrong.

$P + Q$  will be odd, but not all odd numbers are prime numbers. For example, if  $P = 5$  and  $Q = 4$ , then  $P + Q = 9$ , but 9 is not a prime number as it is divisible by 3.

1) Factorise and solve the following equations:

$$a) x^2 + 5x + 6 = 0 \quad (x + 2)(x + 3) = 0 \quad x = -2 \text{ or } -3$$

$$b) x^2 + 9x + 20 = 0 \quad (x + 4)(x + 5) = 0 \quad x = -4 \text{ or } -5$$

$$c) x^2 + x - 6 = 0 \quad (x + 3)(x - 2) = 0 \quad x = -3 \text{ or } 2$$

$$d) x^2 + 5x - 24 = 0 \quad (x + 8)(x - 3) = 0 \quad x = -8 \text{ or } 3$$

$$e) x^2 - 6x + 8 = 0 \quad (x - 2)(x - 4) = 0 \quad x = 2 \text{ or } 4$$

$$f) x^2 - 3x - 28 = 0 \quad (x - 7)(x + 4) = 0 \quad x = 7 \text{ or } -4$$

$$g) 2x^2 + 7x + 3 = 0 \quad (x + 3)(2x + 1) = 0 \quad x = -3 \text{ or } -\frac{1}{2}$$

$$h) 6x^2 + 11x + 3 = 0 \quad (2x + 3)(3x + 1) = 0 \quad x = -\frac{3}{2} \text{ or } -\frac{1}{3}$$

$$i) 3x^2 + 13x - 10 = 0 \quad (x + 5)(3x - 2) = 0 \quad x = -5 \text{ or } \frac{2}{3}$$

$$j) 3x^2 - 34x + 63 = 0 \quad (3x - 7)(x - 9) = 0 \quad x = \frac{7}{3} \text{ or } 9$$

2) Lucy said that -1 is the only solution of  $x$  that satisfies the equation

$$x^2 + 2x + 1 = 0$$

Was Lucy correct? **Yes**

Show working to justify your answer

$$x^2 + 2x + 1 = 0$$

$$(x + 1)(x + 1) = 0$$

$$\text{so } x = -1$$

3) Ben said that -5 is the only solution of  $x$  that satisfies the equation

$$x^2 + 10x + 25 = 0$$

Was Ben correct? **Yes**

Show working to justify your answer

$$x^2 + 10x + 25 = 0$$

$$(x + 5)(x + 5) = 0$$

$$\text{so } x = -5$$

## The Difference of Two Squares

1) Factorise

a)  $x^2 - 16$

$(x - 4)(x + 4)$

c)  $y^2 - 9$

$(y - 3)(y + 3)$

e)  $x^2 - \frac{1}{4}$

$(x - \frac{1}{2})(x + \frac{1}{2})$

b)  $a^2 - b^2$

$(a - b)(a + b)$

d)  $x^2 - 1$

$(x - 1)(x + 1)$

f)  $x^2 - \frac{1}{9}$

$(x - \frac{1}{3})(x + \frac{1}{3})$

2) Factorise

a)  $x^2 - 4y^2$

$(x - 2y)(x + 2y)$

c)  $9x^2 - 16y^2$

$(3x - 4y)(3x + 4y)$

e)  $4x^2 - 25y^2$

$(2x - 5y)(2x + 5y)$

b)  $9a^2 - b^2$

$(3a - b)(3a + b)$

d)  $\frac{1}{4}x^2 - y^2$

$(\frac{1}{2}x - y)(\frac{1}{2}x + y)$

f)  $x^2 - \frac{1}{9}y^2$

$(x - \frac{1}{3}y)(x + \frac{1}{3}y)$

3) Simplify

a)  $\frac{y^2 - 4}{y + 2} \times \frac{5}{y + 5} = \frac{5(y - 2)}{y + 5}$

b)  $\frac{3}{2x + 1} \times \frac{4x^2 - 1}{x - 2} = \frac{3(2x - 1)}{x - 2}$

c)  $\frac{12x^2 + 8x}{9x^2 - 4} = \frac{4x}{3x - 2}$

d)  $\frac{25a^2 - 16b^2}{10ab - 8b^2} = \frac{5a + 4b}{2b}$

4) Solve

a)  $4x^2 - 16 = 0$

$x = 2, x = -2$

c)  $49x^2 = 121$

$x = 1\frac{4}{7}, x = -1\frac{4}{7}$

b)  $25x^2 = 1$

$x = \frac{1}{5}, x = -\frac{1}{5}$

d)  $9x^2 - 9 = 7$

$x = 1\frac{1}{3}, x = -1\frac{1}{3}$

## Finding the Equation of a Straight Line

1) Find the equations of lines A, B and C on the axes below

A:  $y = 2x + 1$   
 B:  $y = 0.5x + 4$   
 C:  $y = -x + 8$

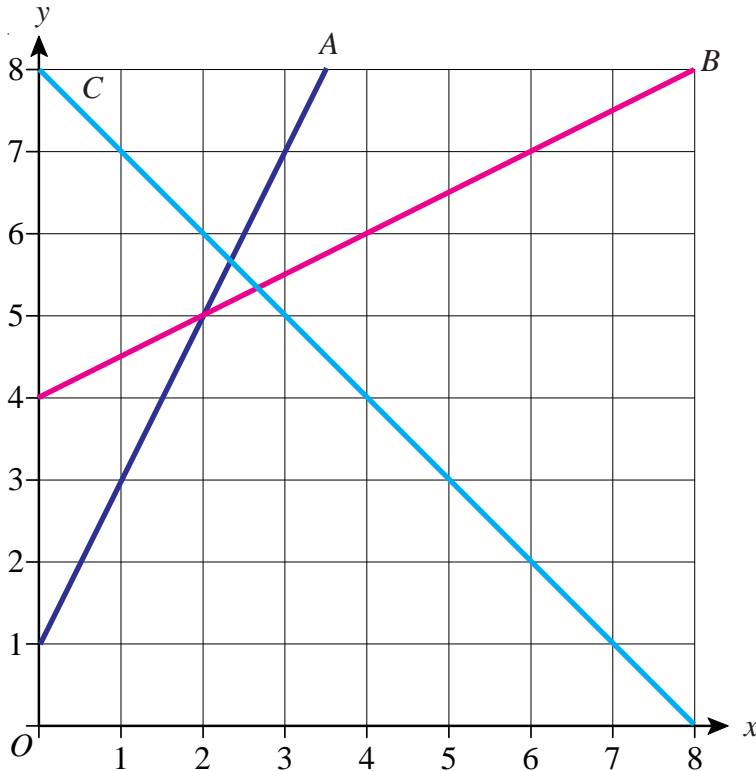

2) Find the equations of lines A, B and C on the axes below

A:  $y = 2x - 2$   
 B:  $y = -0.5x + 4$   
 C:  $y = -x$

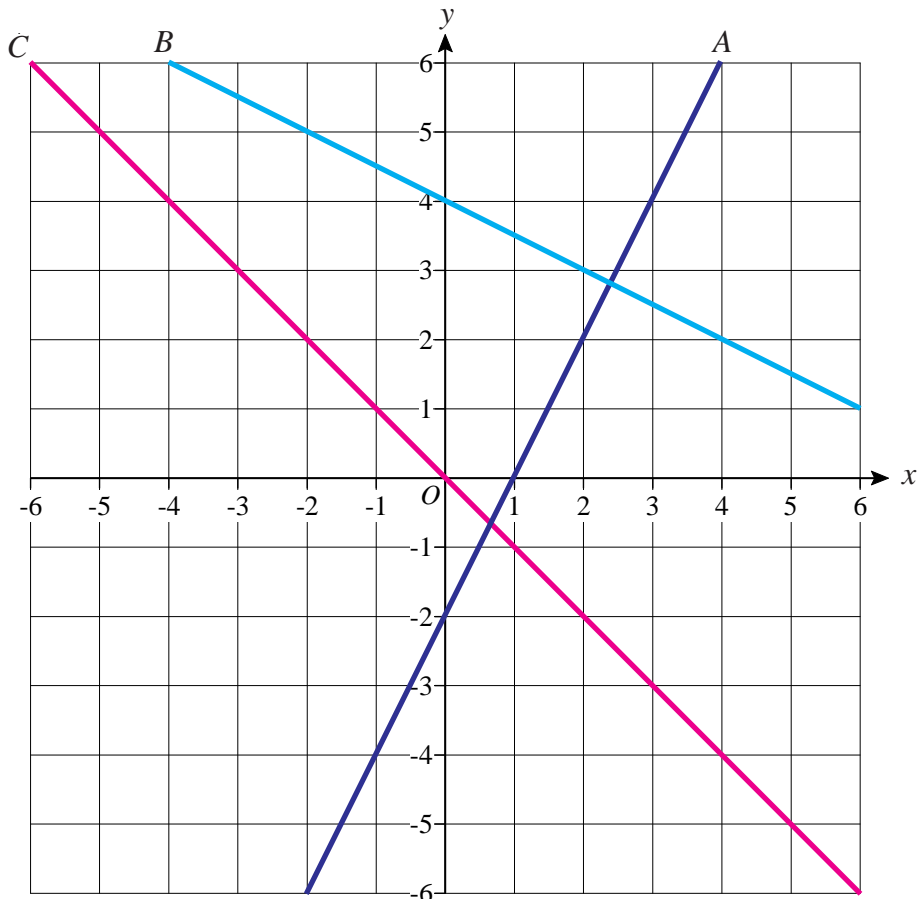



## Finding the Equation of a Straight Line

- 1) Find the equation of line A on the grid below.  $y = 3x - 2$

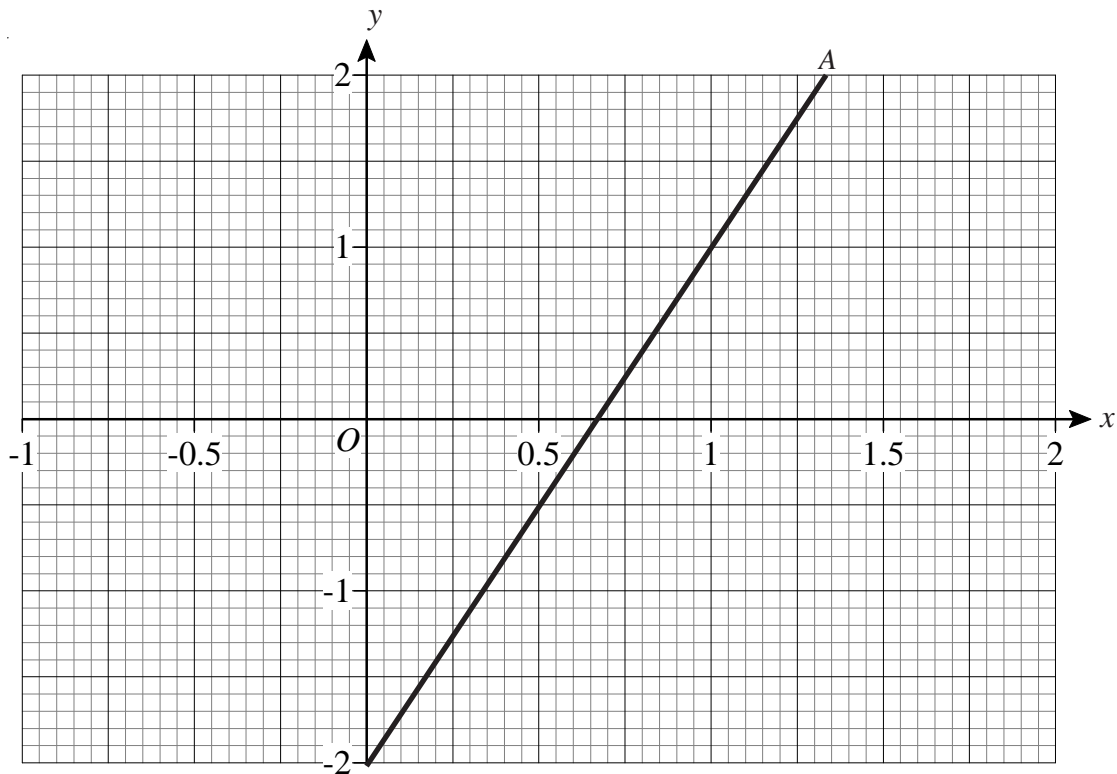

- 2) A straight line passes through points (0, 4) and (3, 13).  
What is its equation?  $y = 3x + 4$



- 3) A straight line passes through points (0, 7) and (2, -1).  
What is its equation?  $y = -4x + 7$



- 4) A straight line is parallel to  $y = 3x - 2$  and goes through (1, 8).  
What is its equation?  $y = 3x + 5$



- 5) A straight line is parallel to  $y = 2x + 5$  and goes through (5, 6).  
What is its equation?  $y = 2x - 4$



- 6) A is the point (-1, 2).  
B is the point (1, 6).  
C is the point (0, -1).  
Find the equation of the line which passes through C  
and is parallel to AB.  $y = 2x - 1$

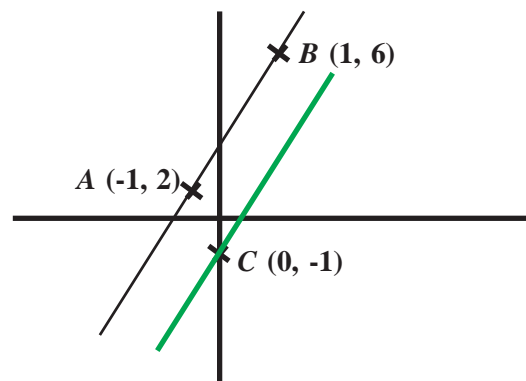

## Roots and Turning Points of Quadratics

1) The graph of  $y = x^2 - 2x - 3$  is shown.

Write down the coordinates of:

- The turning point of the curve.  $(1, -4)$
- The roots of the equation  $x^2 - 2x - 3 = 0$   $(-1, 0), (3, 0)$
- The intersection of the curve with the  $y$ -axis.  $(0, -3)$

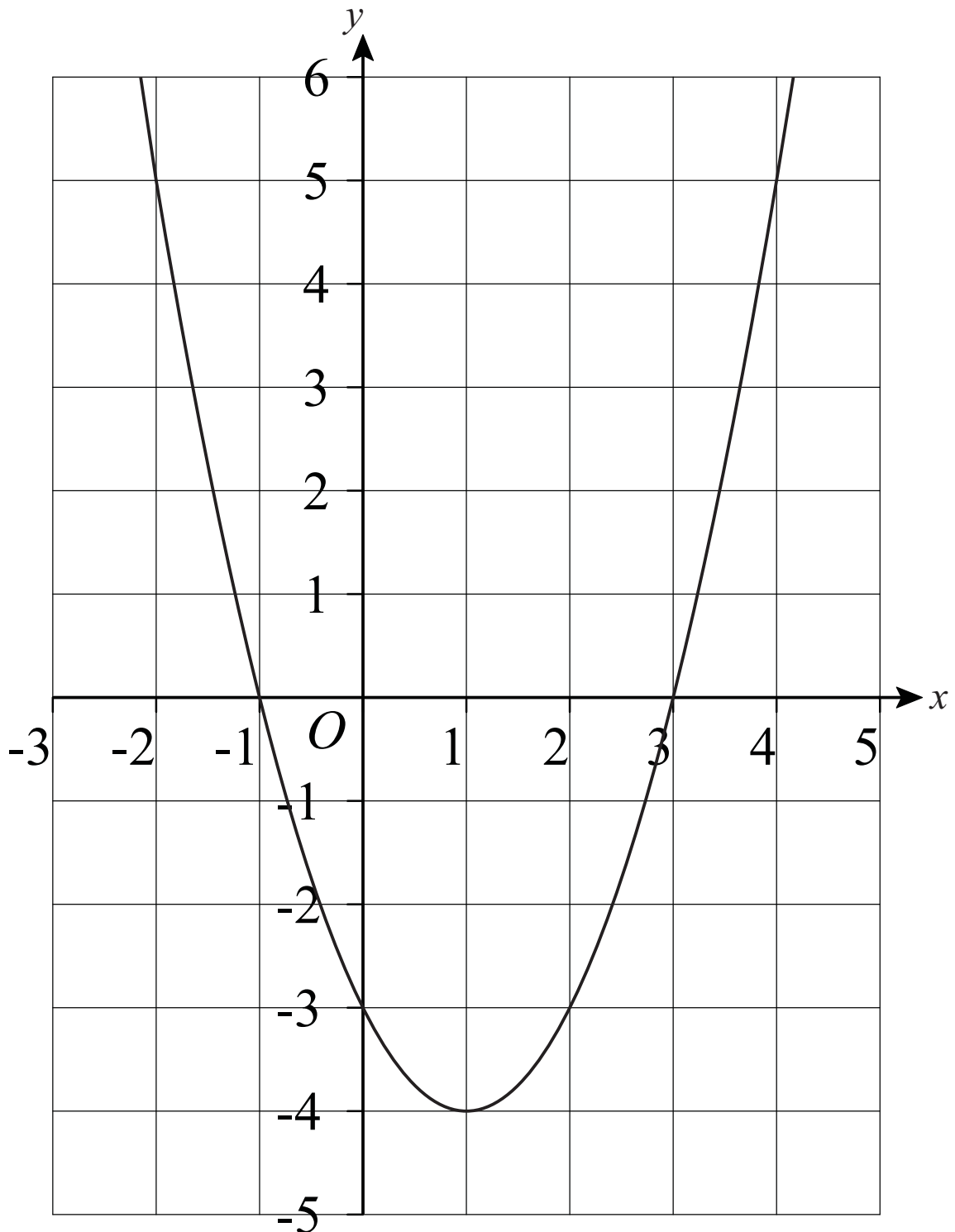

### Cubic and Reciprocal Graphs



1) a) Complete this table of values for

$$y = x^3 + x - 4$$

x	-2	-1	0	1	2
y	-14	-6	-4	-2	6

b) On the grid, draw the graph of

$$y = x^3 + x - 4$$

c) Use the graph to find the value of x when y = 2

$$x = 1.75$$

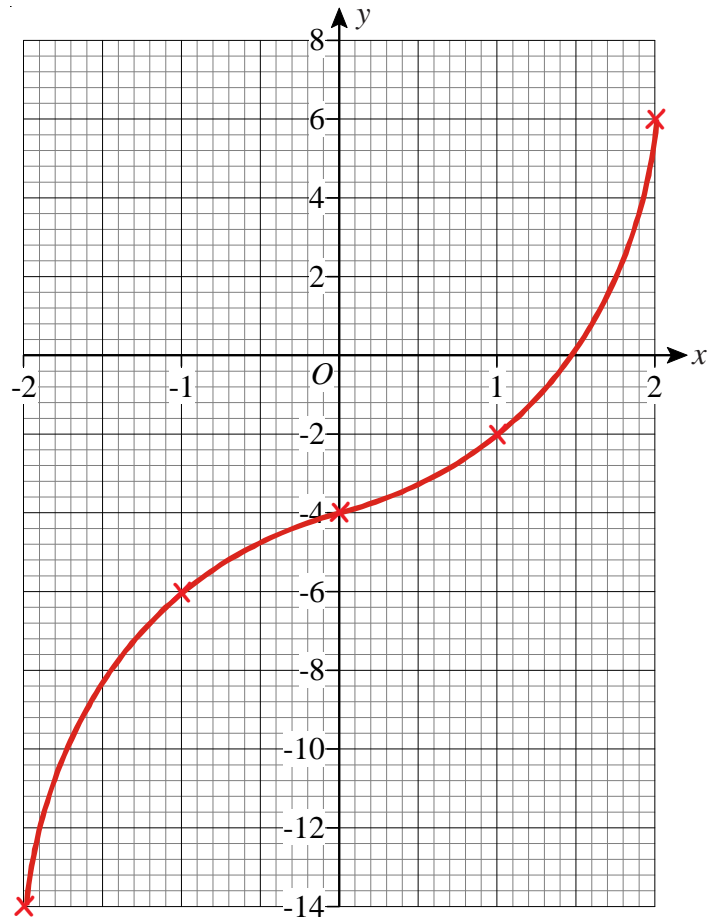

2) a) Complete this table of values for

$$y = x^3 + 2x$$

x	-2	-1	0	1	2
y	-12	-3	0	3	12

b) On the grid, draw the graph of

$$y = x^3 + 2x$$

c) Use the graph to find the value of x when y = -6

$$x = -1.5$$

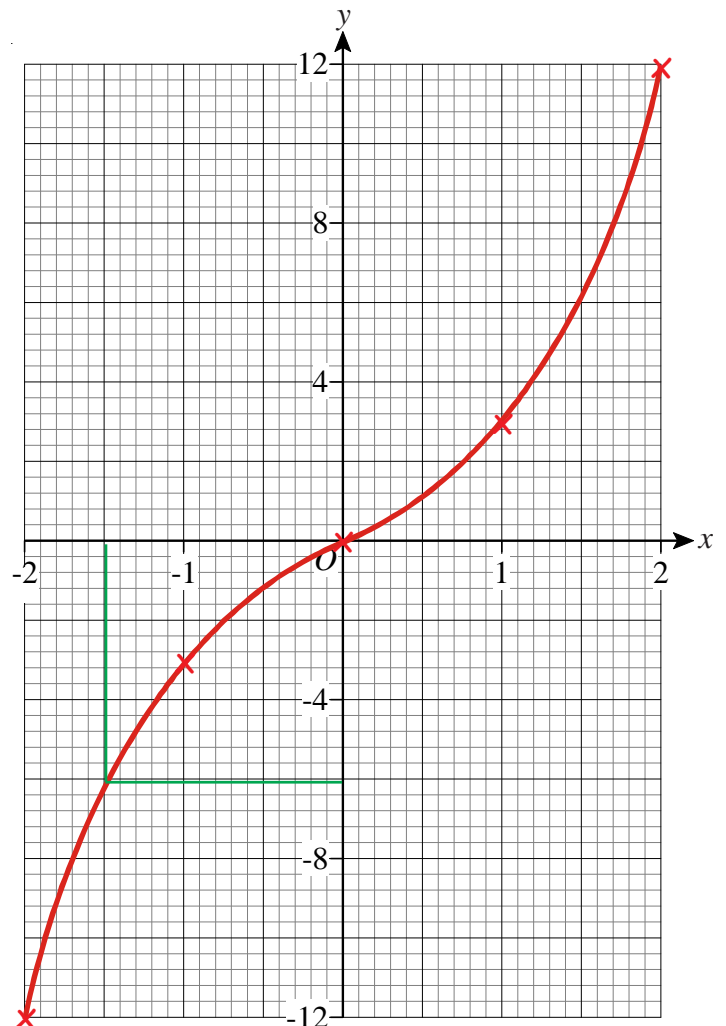

3) Sketch the graph of  $y = 1 + \frac{1}{x}$

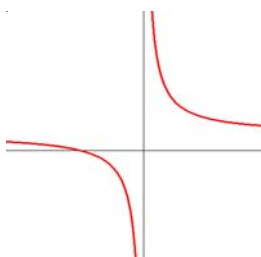

## Simultaneous Equations Algebraically

1) Solve

$$\begin{aligned}4x + 3y &= 6 \\5x - 3y &= 21\end{aligned}$$

$$x = 3 \text{ and } y = -2$$

2) Solve

$$\begin{aligned}4x + 3y &= 19 \\3x - 5y &= 7\end{aligned}$$

$$x = 4 \text{ and } y = 1$$

3) Solve

$$\begin{aligned}3x + 5y &= 13 \\2x + 3y &= 8\end{aligned}$$

$$x = 1 \text{ and } y = 2$$



4) Solve

$$\begin{aligned}x + 4y &= 5 \\4x - 2y &= 11\end{aligned}$$

$$x = 3 \text{ and } y = 0.5$$



5) Solve

$$\begin{aligned}2a + b &= 3 \\4a - 5b &= 20\end{aligned}$$

$$a = 2.5 \text{ and } b = -2$$

6) Solve

$$\begin{aligned}5x + 3y &= 4 \\3x + 4y &= 9\end{aligned}$$

$$x = -1 \text{ and } y = 3$$



7) Solve

$$\begin{aligned}6x - 2y &= 13 \\2x + 3y &= -3\end{aligned}$$

$$x = 1.5 \text{ and } y = -2$$



8) Solve

$$\begin{aligned}3a - 2b &= 14 \\4a + 3b &= 13\end{aligned}$$

$$a = 4 \text{ and } b = -1$$



9) Solve

$$\begin{aligned}5x + 4y &= 5 \\2x + 7y &= 29\end{aligned}$$

$$x = -3 \text{ and } y = 5$$



10) Solve

$$\begin{aligned}6x - 4y &= 39 \\2x + y &= 6\end{aligned}$$

$$x = 4.5 \text{ and } y = -3$$

- 1) The 1st term of a geometric progression is 5 and the common ratio is 2.
- a) Write down the first four terms of the progression. **5, 10, 20, 40**
- b) What is the 10th term of the progression? **2560**

- 2) The 1st term of a geometric progression is 2 and the common ratio is 4.
- a) Write down the first four terms of the progression. **2, 8, 32, 128**
- b) What is the 7th term of the progression? **8192**



- 3) The 1st and 3rd terms of a geometric progression are 7 and 63.
- a) What is the common ratio of the progression? **3**
- b) Write down the first four terms. **7, 21, 63, 189**
- c) Work out the 15th term of the progression. **33480783**



- 4) The 5th term of a geometric progression is 11664.  
The 6th term of the progression is 69984.  
What is the 1st term of the progression? **9**



- 5) The first four terms of a geometric progression are 1875, 375, 75, 15, ...
- a) What is the common ratio of the progression? **0.2**
- b) Work out the 8th term of the progression. **0.024**



- 6) The third term of a geometric progression is 192.  
The 4th term of the progression is 48.  
What is the 1st term of the progression? **3072**

## Compound Interest and Depreciation



- 1) Henry places £6000 in an account which pays 4.6% compound interest each year.

Calculate the amount in his account after 2 years. **£6564.70**



- 2) Sarah puts £8600 in a bank. The bank pays compound interest of 3.8% per year.

Calculate the amount Sarah has in her account after 4 years. **£9983.62**



- 3) Mary deposits £10000 in an account which pays 5.6% compound interest per year.

How much will Mary have in her account after 5 years? **£13131.66**



- 4) Susan places £7900 in an account which pays 2.4% compound interest per year.

How much interest does she earn in 3 years? **£582.56**



- 5) Harry puts money into an account which pays 6% compound interest per year.

If he puts £23000 in the account for 5 years how much interest will he earn altogether? **£7779.19**



- 
- 6) Laura buys a new car for £14600.

The annual rate of depreciation is 23%.

How much is the car worth after 3 years? **£6665.38**



- 7) The rate of depreciation of a particular brand of computer is 65% per year. If the cost of the computer when new is £650 how much is it worth after 2 years? **£79.63**



- 8) Sharon pays £3500 for a secondhand car.

The annual rate of depreciation of the car is 24%

How much will it be worth four years after she has bought it? **£1167.68**



- 
- 9) Dave places £17000 in an account which pays 4% compound interest per year.

How many years will it take before he has £19122.69 in the bank? **3 years**



- 10) A new motorbike costs £8900.

The annual rate of depreciation is 18% per year.

After how many years will it be worth £2705.66? **6 years**

1)

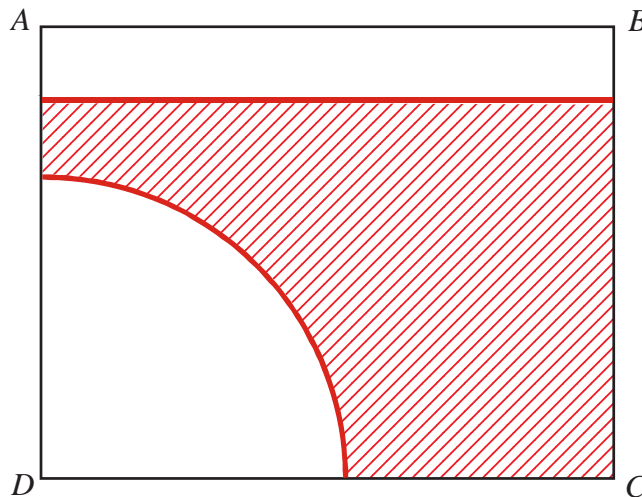

$ABCD$  is a rectangle.

Shade the set of points inside the rectangle which are **both** more than 4 centimetres from the point  $D$  **and** more than 1 centimetre from the line  $AB$ .

2) Two radio transmitters,  $A$  and  $B$ , are situated as below.

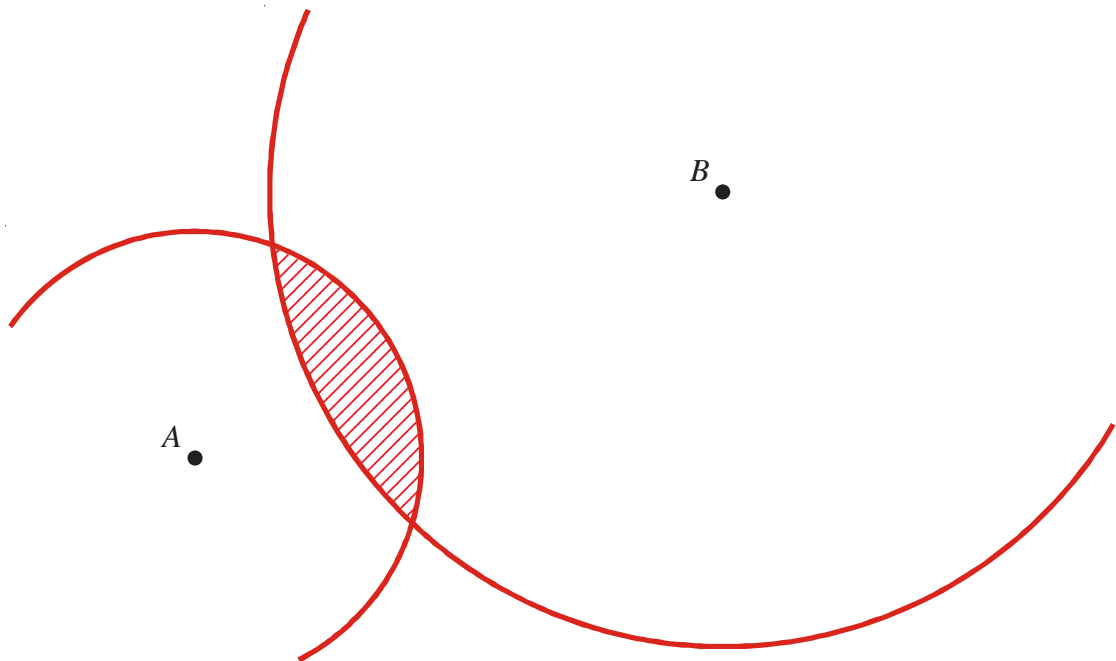

Transmitter  $A$  broadcasts signals which can be heard up to 3 km from  $A$ .

Transmitter  $B$  broadcasts signals which can be heard up to 6 km from  $B$ .

Shade in the area in which radio signals can be heard from both transmitters.  
 Use a scale of 1 cm = 1 km.

- 1) Draw the locus of all points which are equidistant from the lines  $AB$  and  $AC$ .

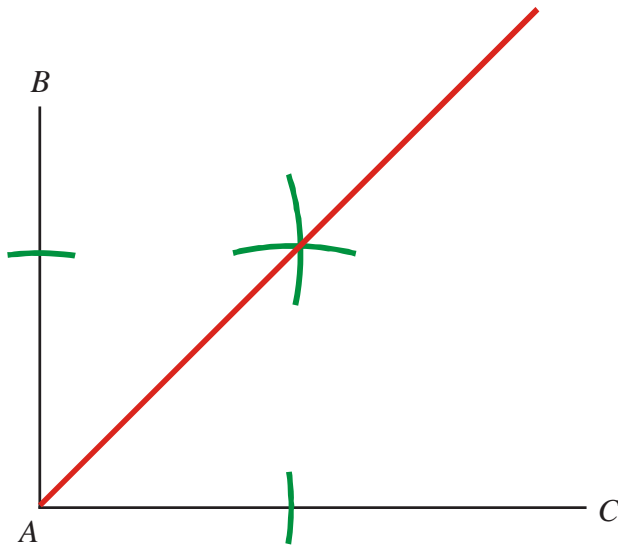

- 2) Draw the locus of all points which are equidistant from the points  $A$  and  $B$ .

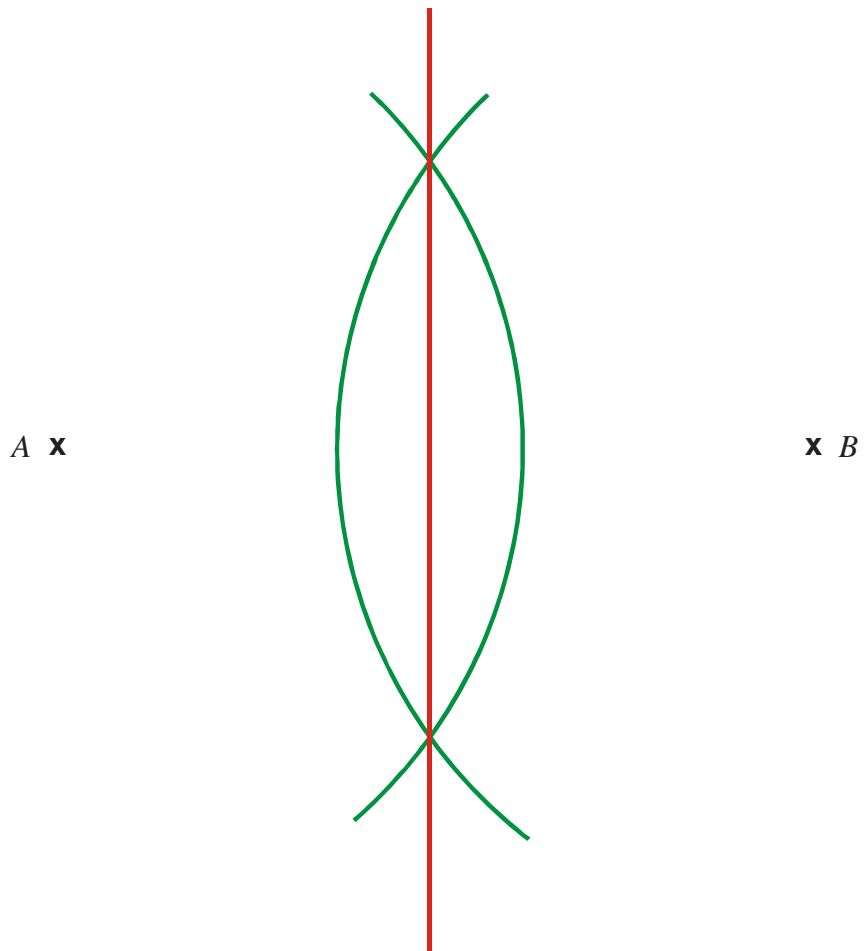



- 1) Draw the locus of all points that are exactly 3 cm from the line  $PQ$ .

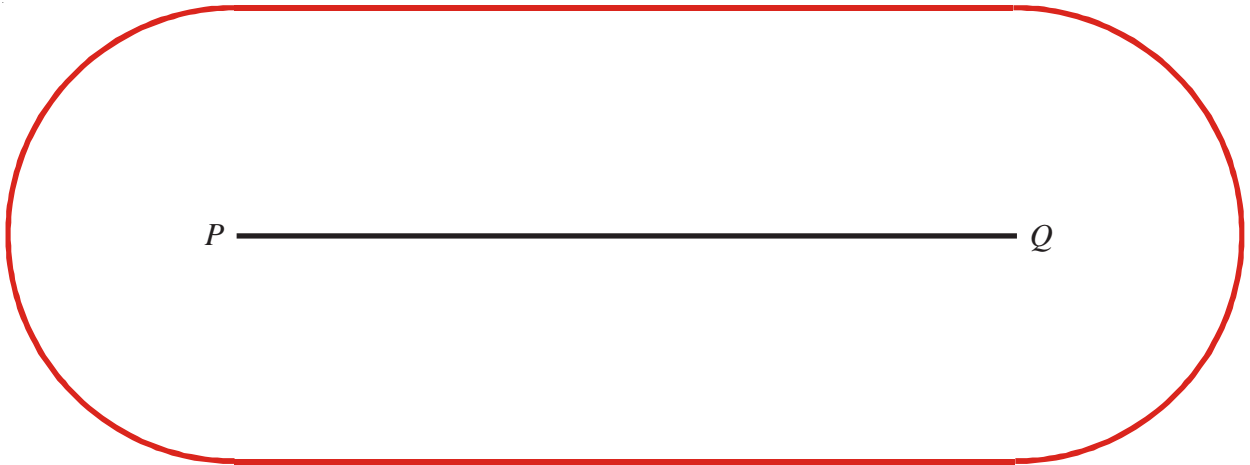

- 2) Draw the locus of all points that are exactly 4 cm from the rectangle  $ABCD$

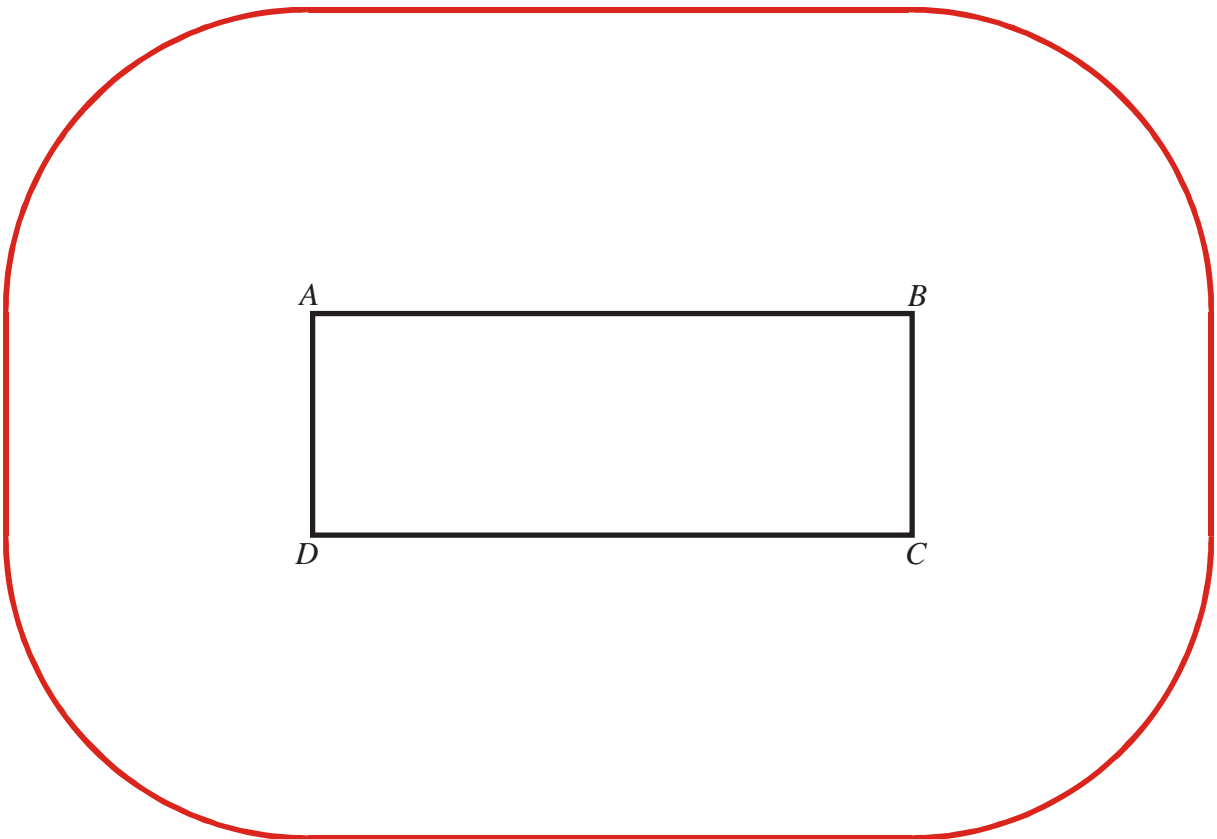

- 1)  $ABCD$  is a quadrilateral.

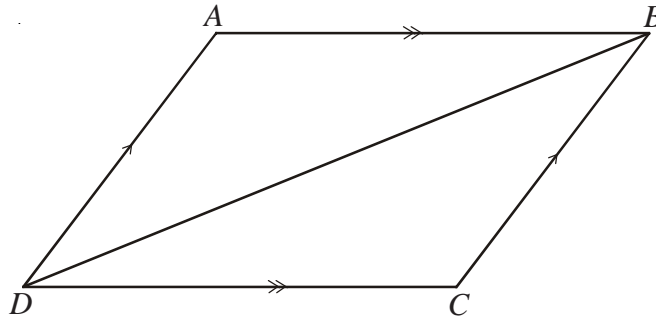

$AB$  is parallel to  $DC$ .  
 $DA$  is parallel to  $CB$ .

Prove that triangle  $ABD$  is congruent to triangle  $CDB$ .

$AB = CD$  (opp. sides of parallelogram are equal)  
 $AD = CB$  (opp. sides of parallelogram are equal)  
 $DB$  is a shared side.  
 Therefore  $ABD$  is congruent to  $CDB$  (SSS)

- 2)

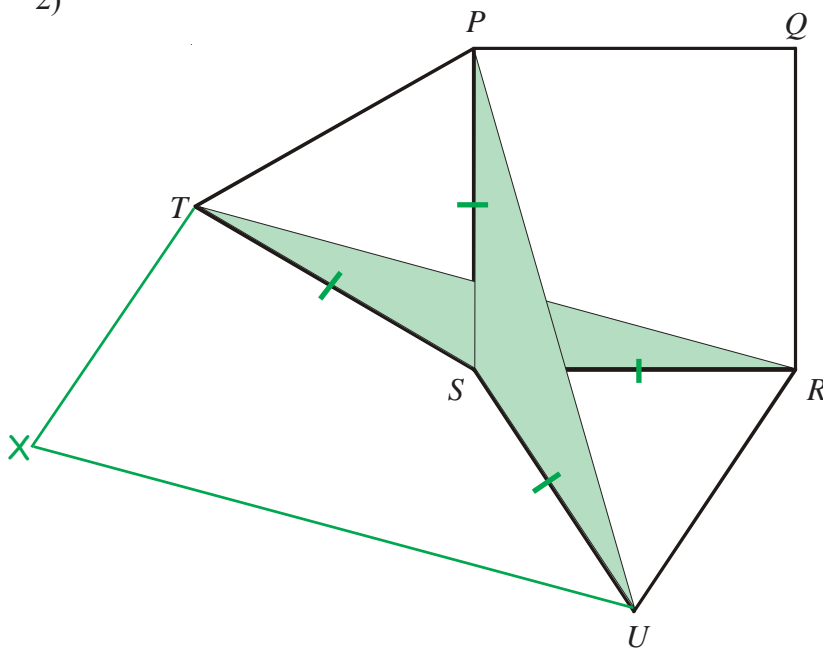

$PQRS$  is a square.  
 $PTS$  and  $SUR$  are equilateral triangles.

- a) Prove that triangle  $USP$  is congruent to triangle  $TSR$ .

$US = TS$   
 $SP = SR$   
 Angle  $USP = 60^\circ + 90^\circ = 150^\circ$   
 Angle  $TSR = 60^\circ + 90^\circ = 150^\circ$   
 $USP$  is congruent to  $TSR$  (SAS)

$X$  is the point such that  $RUXT$  is a parallelogram.

- b) Prove that  $UP = UX$

$UP = RT$  (corresponding sides of congruent triangles)  
 $RT = UX$  (opp. sides of parallelogram are equal)  
 Therefore  $UP = UX$

## Congruent Triangles

1)

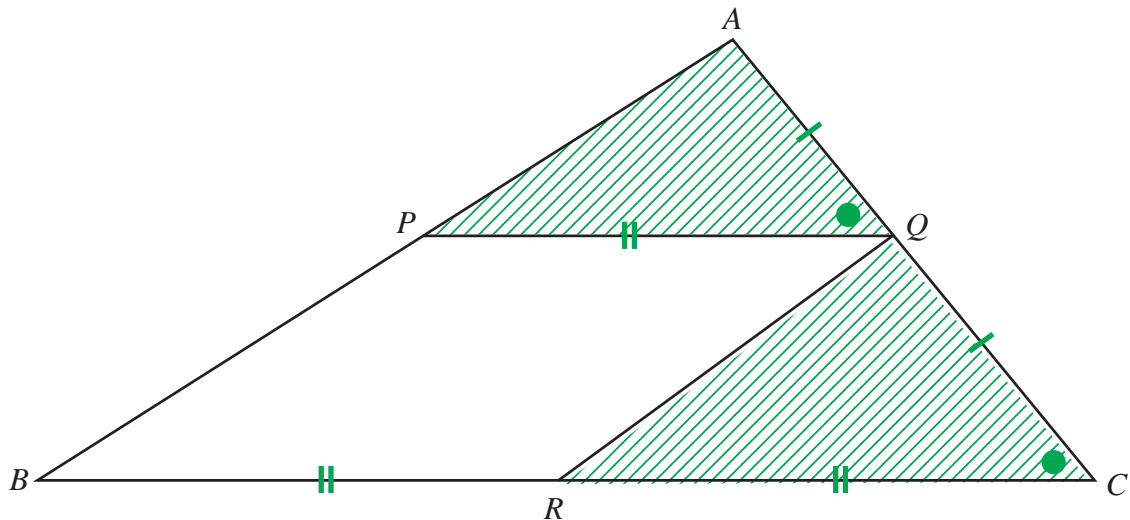

The diagram shows a triangle  $ABC$ .

$PQRB$  is a parallelogram where  
 $P$  is the midpoint of  $AB$ ,  
 $Q$  is the midpoint of  $AC$ ,  
 and  $R$  is the midpoint of  $BC$ .

$AQ = QC$  ( $Q$  is midpoint of  $AC$ )  
 Angle  $AQP =$  angle  $QCR$  (corresponding angles)  
 $PQ = BR$  (opposite sides of parallelogram)  
 $BR = RC$  ( $R$  is midpoint of  $BC$ )  
 $\therefore PQ = RC$   
 $\therefore APQ$  is congruent to  $QRC$  (SAS)

Prove that triangle  $APQ$  and triangle  $QRC$  are congruent.  
 You must give reasons for each stage of your proof.

2)

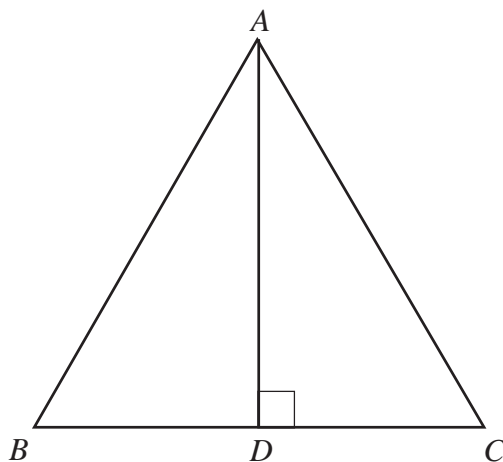

$ABC$  is an equilateral triangle.  
 $D$  lies on  $BC$ .  
 $AD$  is perpendicular to  $BC$ .

Angle  $ADB =$  angle  $ADC = 90^\circ$  ( $AD$  is perp. to  $BC$ )  
 $AB = AC$  (equilateral triangle)  
 $AD$  is a side in triangles  $ADC$  and  $ADB$   
 $\therefore$  Triangle  $ADC$  is congruent to triangle  $ADB$  (RHS)

- a) Prove that triangle  $ADC$  is congruent to triangle  $ADB$ .  
 $\therefore BD = DC$   
 $BD = \frac{1}{2} BC$   
 $BC = AB$  (equilateral triangles)  
 $\therefore BD = \frac{1}{2} AB$
- b) Hence, prove that  $BD = \frac{1}{2} AB$



1) This sector of a circle has radius 16 cm.

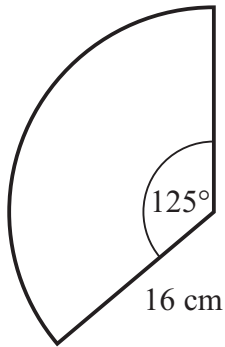

- a) Find the area of the sector. **279.29 cm<sup>2</sup>**
- b) Find the perimeter of the sector. **66.91 cm**



2) A quadrant of a circle is shown.

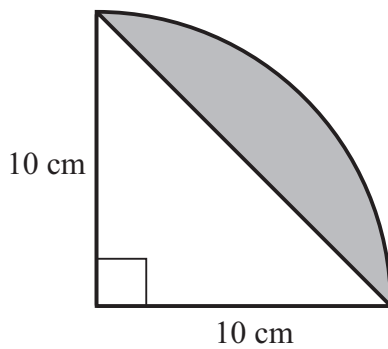

Work out the area of the shaded section. **28.55 cm<sup>2</sup>**



3) The diagram shows a sector of a circle.

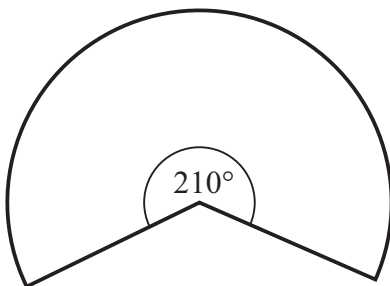

The arc length is 47.6 cm.

Work out the radius. **13 cm**

## Trigonometry



- 1)  $ABC$  is a right-angled triangle.  
 $AB = 50$  cm.  
 Angle  $ABC = 24^\circ$   
 Work out the length of  $BC$ .  
 Give your answer correct to 1 decimal place.

**45.7 cm**

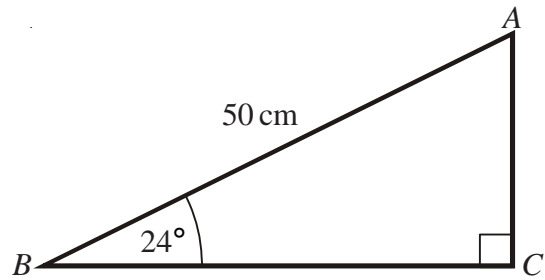

- 2)  $ABC$  is a right-angled triangle.  
 $AB = 23$  cm.  
 Angle  $BCA = 20^\circ$   
 Work out the length of  $AC$ .  
 Give your answer correct to 1 decimal place.

**67.2 cm**

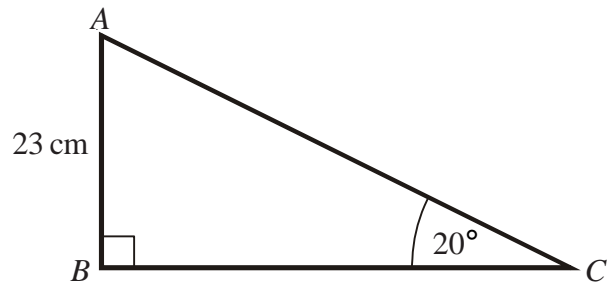

- 3)  $ABC$  is a right-angled triangle.  
 $AC = 16$  cm.  
 Angle  $CAB = 65^\circ$   
 Work out the length of  $BC$ .  
 Give your answer correct to 1 decimal place.

**34.3 cm**

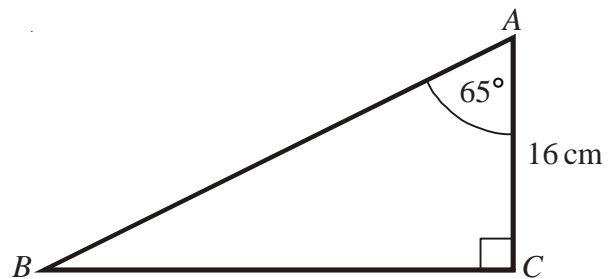

- 4)  $ABC$  is a right-angled triangle.  
 $AB = 13$  cm.  
 $AC = 21$  cm.  
 Work out the size of angle  $x$ .  
 Give your answer correct to 1 decimal place.

**51.8°**

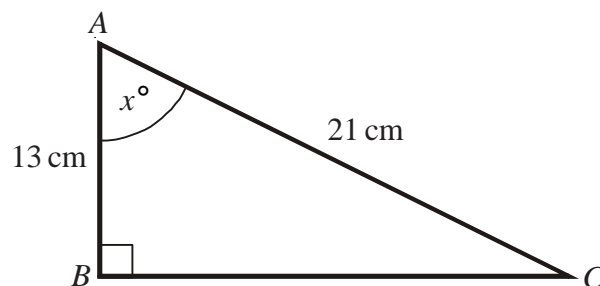

- 5)  $ABC$  is a right-angled triangle.  
 $AB = 18$  cm.  
 $AC = 7$  cm.  
 Work out the size of angle  $ABC$ .  
 Give your answer correct to 1 decimal place.

**22.9°**

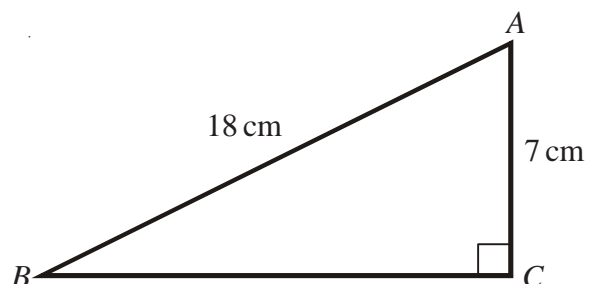

## Trigonometry



- 1)  $PQR$  is a right-angled triangle.  
 $PR = 11$  cm.  
 $QR = 4.5$  cm  
 Angle  $PRQ = 90^\circ$

Work out the value of  $x$ .  
 Give your answer correct to 1 decimal place.

**22.2°**

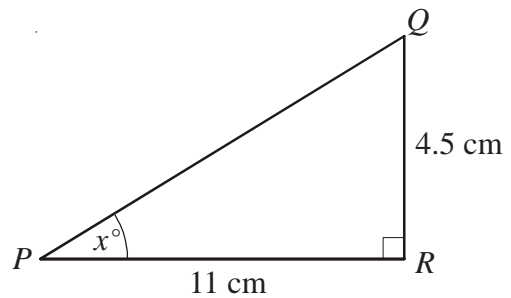

- 2)  $AC = 14$  cm.  
 Angle  $ABC = 90^\circ$   
 Angle  $ACB = 34^\circ$

Calculate the length of  $BC$ .  
 Give your answer correct to 3 significant figures.

**11.6 cm**

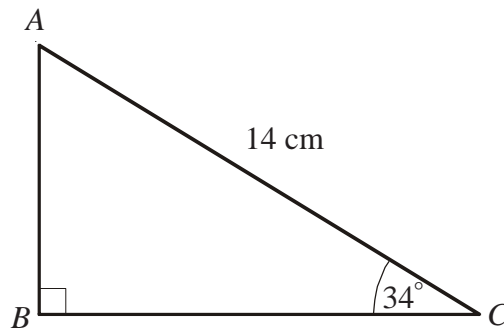

- 3)  $PQR$  is a right-angled triangle.  
 $PQ = 18$  cm.  
 $QR = 8.4$  cm  
 Angle  $PRQ = 90^\circ$

Work out the value of  $x$ .  
 Give your answer correct to 1 decimal place.

**27.8°**

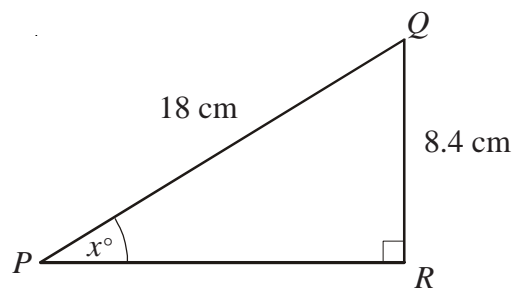

- 4)  $AB = 23$  cm.  
 Angle  $ABC = 90^\circ$   
 Angle  $ACB = 21^\circ$

Calculate the length of  $AC$ .  
 Give your answer correct to 3 significant figures.

**64.2 cm**

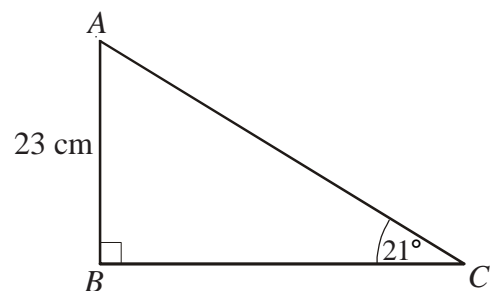

- 5) A lighthouse,  $L$ , is 3.4 km due West of a port,  $P$ .  
 A ship,  $S$ , is 1.8 km due North of the lighthouse,  $L$ .

Calculate the size of the angle marked  $x$ .  
 Give your answer correct to 3 significant figures.

**27.9°**

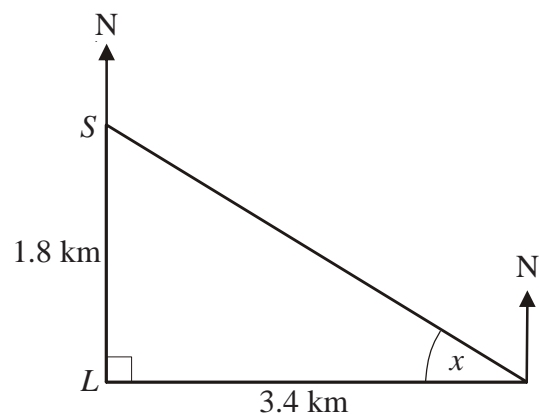

## Trigonometry

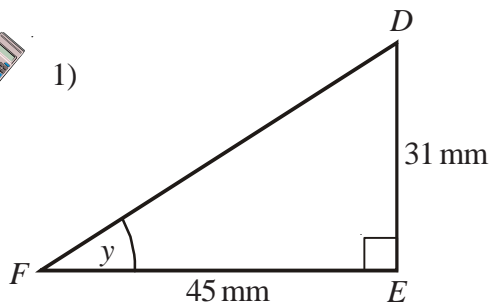

1)

 $DEF$  is a right-angled triangle.

$DE = 31$  mm

$FE = 45$  mm

Calculate the size of angle  $y$ .

Give your answer correct to one decimal place.

$34.6^\circ$

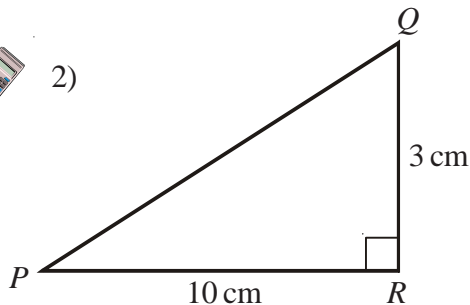

2)

 $PQR$  is a right-angled triangle.

$QR = 3$  cm

$PR = 10$  cm

Work out the size of angle  $RPQ$ .

Give your answer correct to three significant figures.

$16.7^\circ$

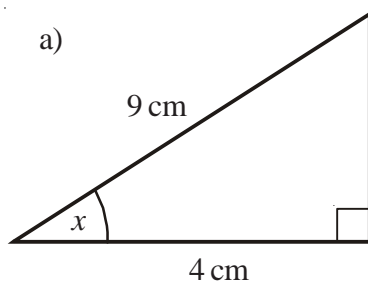

3) a)

Calculate the size of the angle marked  $x$ .

Give your answer correct to one decimal place.

$63.6^\circ$

b)

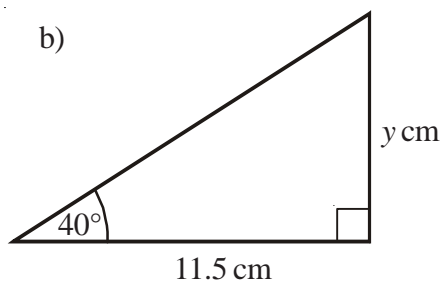
Calculate the value of  $y$ .

Give your answer correct to one decimal place.

$y = 9.6$

## Trigonometry

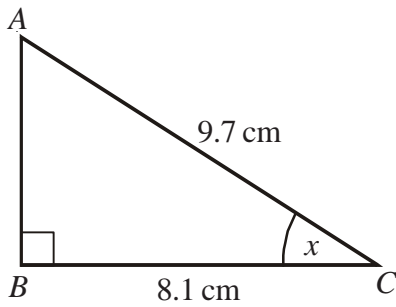

1)

 $ABC$  is a right-angled triangle.

$AC = 9.7$  cm

$BC = 8.1$  cm

Calculate the size of the angle marked  $x$ .

Give your answer correct to three significant figures.

$33.4^\circ$

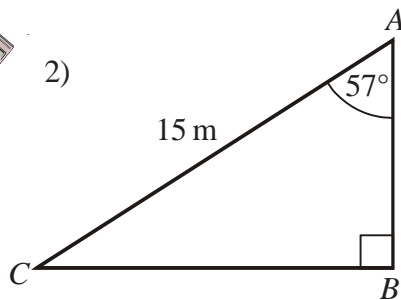

2)

 $ABC$  is a right-angled triangle.

$AC = 15$  m

Angle  $CAB = 57^\circ$

Calculate the length of  $AB$ .

Give your answer correct to three significant figures.

$8.17$  cm

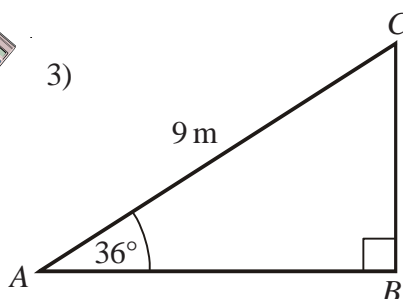

3)

 $ABC$  is a right-angled triangle.

$AC = 9$  m

Angle  $CAB = 36^\circ$

Calculate the length of  $AB$ .

Give your answer correct to three significant figures.

$7.28$  cm



## Trigonometry



1)

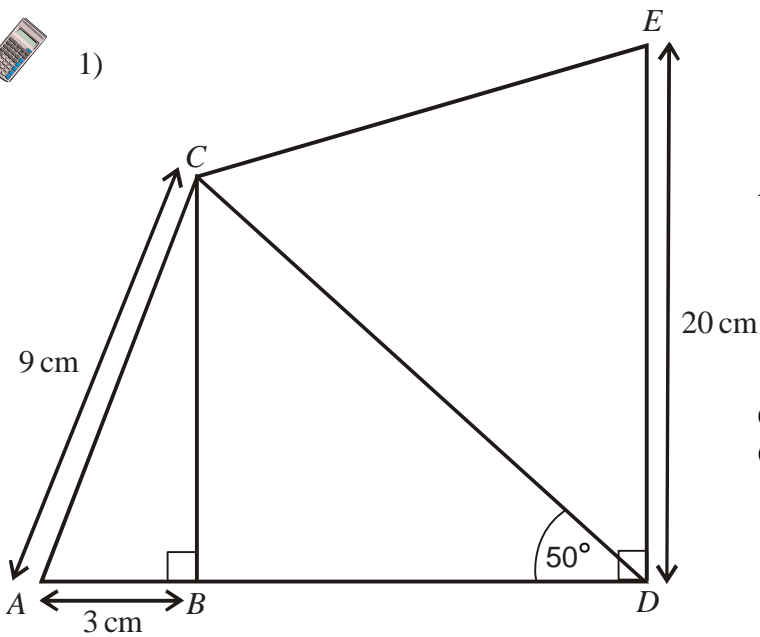

$AC = 9 \text{ cm}$   
 $AB = 3 \text{ cm}$   
 $DE = 20 \text{ cm}$   
 Angle  $ABC = \text{angle } CBD = \text{angle } BDE = 90^\circ$

Calculate the length of  $CD$ .  
 Give your answer to 3 significant figures.

**11.1 cm**



2)

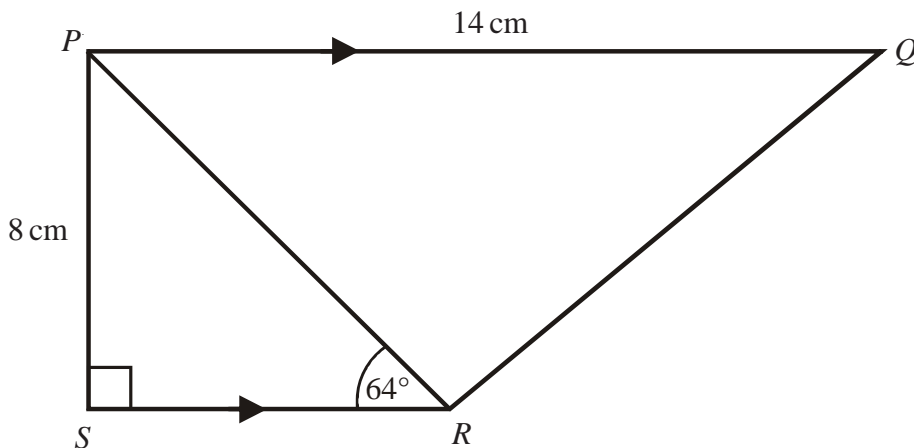

$PQRS$  is a trapezium.  
 $PQ$  is parallel to  $SR$ .  
 Angle  $PSR = 90^\circ$   
 Angle  $PRS = 64^\circ$   
 $PQ = 14 \text{ cm}$ .  
 $PS = 8 \text{ cm}$ .

Work out the length of  $PR$ .  
 Give your answer correct to 3 significant figures.

**8.90 cm**

$$\text{Volume of a sphere} = \frac{4}{3}\pi r^3$$

$$\text{Surface area of a sphere} = 4\pi r^2$$



- 1) a) Work out the volume of the sphere. **7239.168 cm<sup>3</sup>**  
 b) Work out the surface area of the sphere. **1809.792 cm<sup>2</sup>**

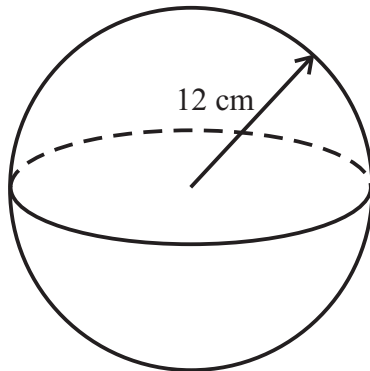

- 2) a) Work out the volume of the sphere, leaving your answer in terms of  $\pi$ .  **$\frac{4000}{3}\pi \text{ cm}^3$**   
 b) Work out the surface area of the sphere, leaving your answer in terms of  $\pi$ .  **$400\pi \text{ cm}^2$**

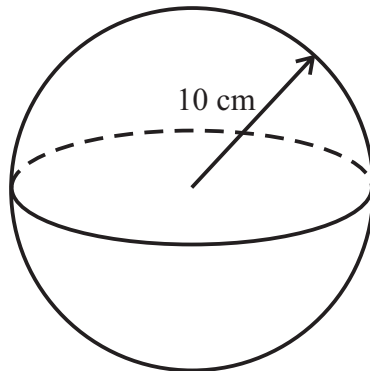

- 3) a) Work out the volume of the solid hemisphere. **348.50 cm<sup>3</sup>**  
 b) Work out the surface area of the solid hemisphere. **285.14 cm<sup>2</sup>**

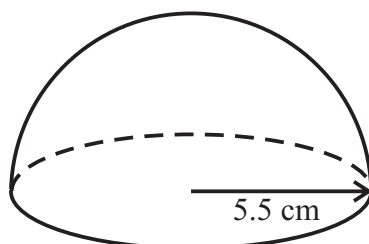

## Pyramids

$$\text{Volume of a pyramid} = \frac{1}{3} \times \text{base area} \times \text{height}$$

- 1) The pyramid has a rectangular base and  $E$  is vertically above  $A$ .

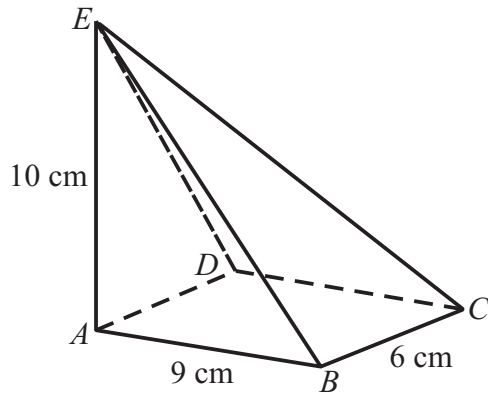

Find the volume of the pyramid. **180 cm<sup>3</sup>**



- 2) Find the volume of this pyramid.

**93.33 cm<sup>3</sup>**

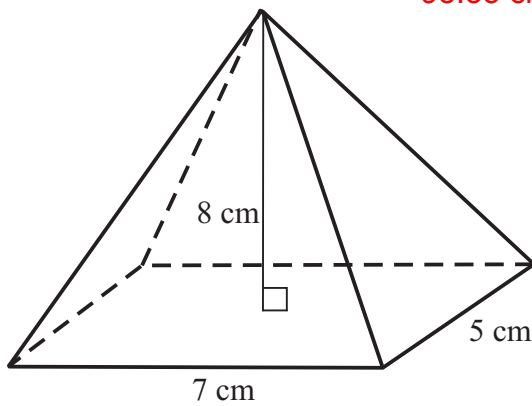

- 3) Find the volume of this pyramid. **138.56 cm<sup>3</sup>**

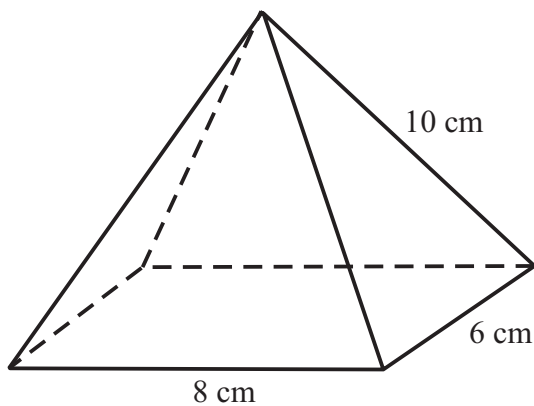

$$\text{Volume of a cone} = \frac{1}{3}\pi r^2 h$$

$$\text{Curved surface area} = \pi r l$$



- 1) a) Work out the volume of the cone. **314.2 cm<sup>3</sup>**  
b) Work out the curved surface area of the cone. **204.23 cm<sup>2</sup>**  
c) The total surface area of the cone. **282.78 cm<sup>2</sup>**

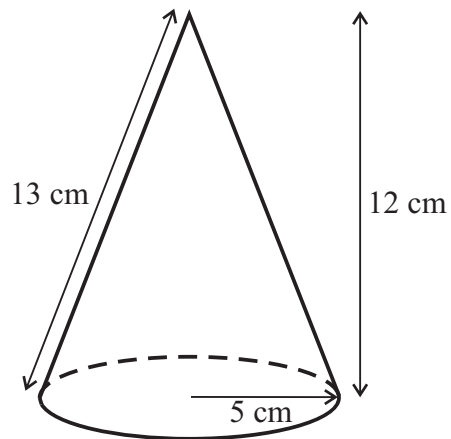

- 2) Work out the volume of the cone, leaving your answer in terms of  $\pi$ . **48 $\pi$  cm<sup>3</sup>**

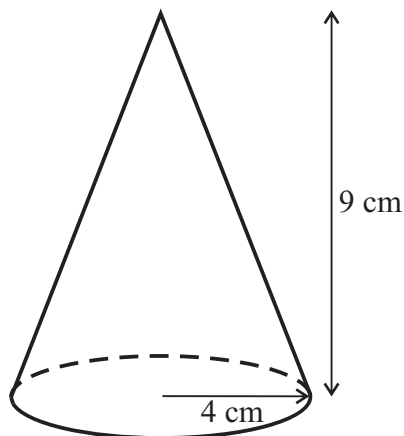

## Spheres and Cones



- 1) A cone has a base radius of 4 cm and a vertical height of 8 cm.

- a) Calculate the volume of the cone.

Take  $\pi$  to be 3.142.

Give your answer correct to 3 significant figures.

**134 cm<sup>3</sup>**

- b) Use Pythagoras' Theorem to find the slant height of the cone.

Give your answer correct to 1 decimal place.

**8.9 cm**

- c) Find the curved surface area of the cone.

Take  $\pi$  to be 3.142.

Give your answer correct to 3 significant figures.

**112 cm<sup>2</sup>**

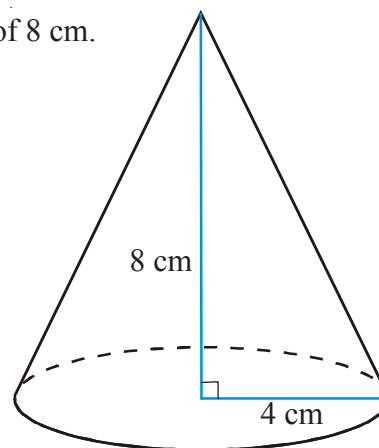

- 2) A sphere has a radius of 12 cm.

- a) Calculate the volume of the sphere.

Take  $\pi$  to be 3.142.

Give your answer correct to 3 significant figures.

**7240 cm<sup>3</sup>**

- b) Find the curved surface area of the sphere.

Take  $\pi$  to be 3.142.

Give your answer correct to 3 significant figures.

**1810 cm<sup>2</sup>**

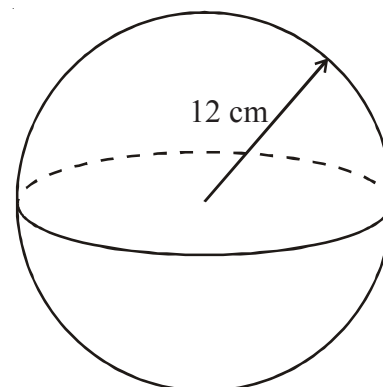

- 3) A cone has a base radius of 8 cm and a slant height of 10 cm.

Calculate the volume of the cone.

Leave your answer in terms of  $\pi$ .

**128 $\pi$  cm<sup>3</sup>**

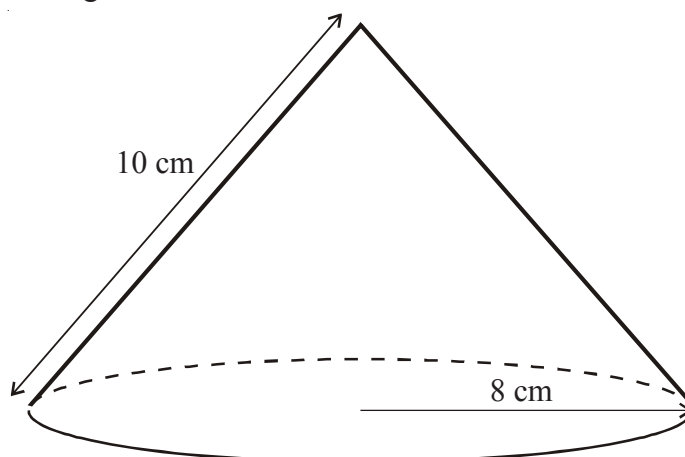

1)

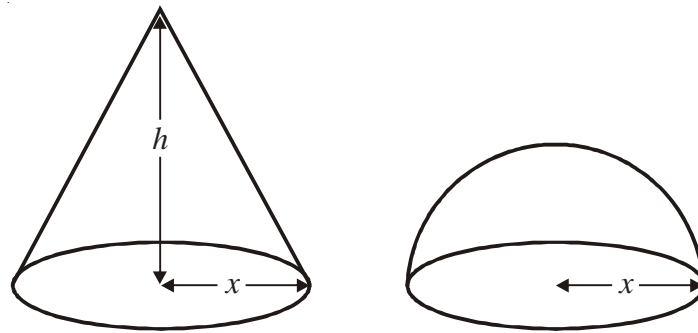

The diagram shows a solid cone and a solid hemisphere.

The cone has a base of radius  $x$  cm and a height of  $h$  cm.

The hemisphere has a base of radius  $x$  cm.

The surface area of the cone is equal to the surface area of the hemisphere.

Find an expression for  $h$  in terms of  $x$ .  $h = \sqrt{3}x$  or  $h = x\sqrt{3}$

2)

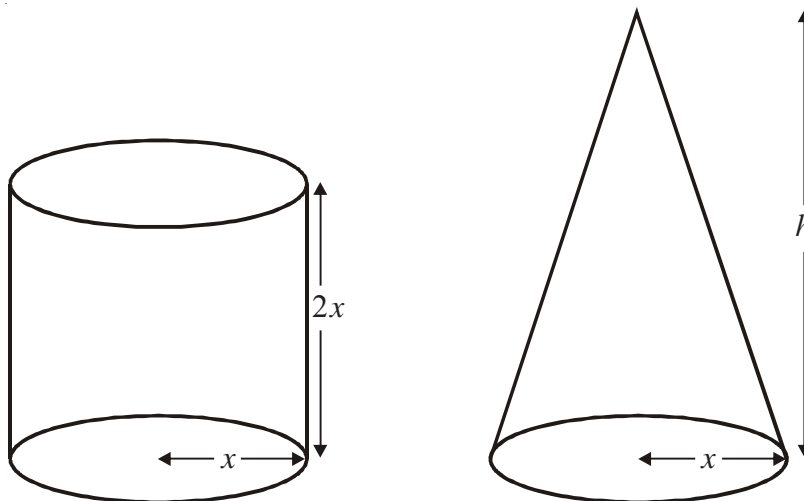

A cylinder has base radius  $x$  cm and height  $2x$  cm.

A cone has base radius  $x$  cm and height  $h$  cm.

The volume of the cylinder and the volume of the cone are equal.

Find  $h$  in terms of  $x$ .

Give your answer in its simplest form.  $h = 6x$



- 1) A frustum is made by removing a small cone from a similar larger cone.

Work out the volume of the frustum. **435.9525 cm<sup>3</sup>**

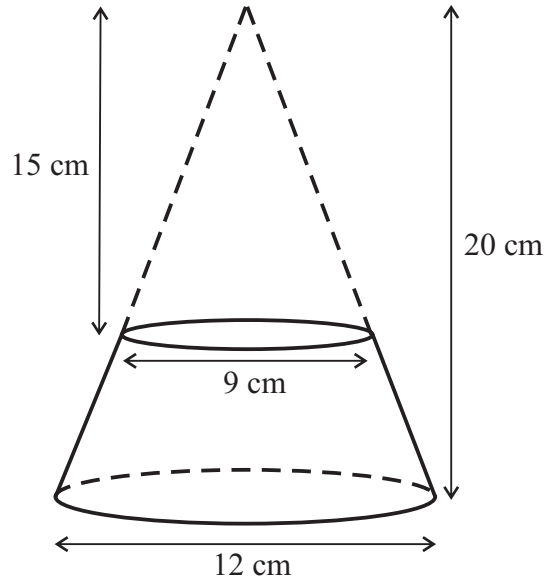

- 2) The diagram shows a cone of height 40 cm and base radius 10 cm. A smaller cone of height 8 cm is removed to form a frustum.

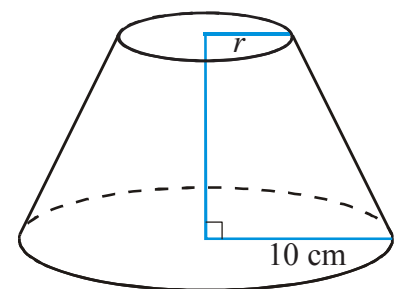
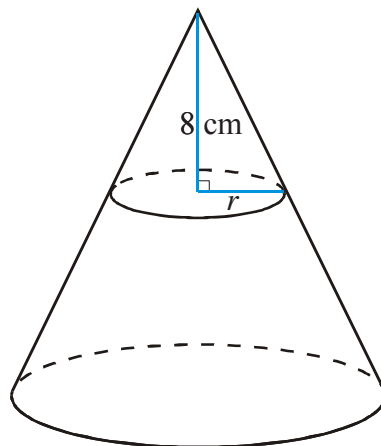
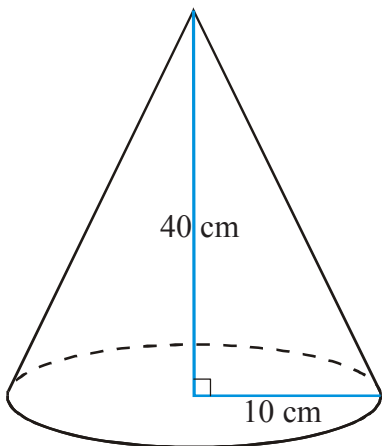

- a) Work out the radius  $r$  of the base of the smaller cone. **2 cm**

Calculate, to the nearest cm<sup>3</sup>

- b) The volume of the larger cone. **4189 cm<sup>3</sup>**  
 c) The volume of the smaller cone. **34 cm<sup>3</sup>**  
 d) The volume of the frustum. **4156 cm<sup>3</sup>**

## Exact Trigonometric Values

1) Write down the exact values of:

- a)  $\sin 0^\circ$  0  
 b)  $\sin 30^\circ$  0.5  
 c)  $\sin 45^\circ$   $\frac{\sqrt{2}}{2}$   
 d)  $\sin 60^\circ$   $\frac{\sqrt{3}}{2}$   
 e)  $\sin 90^\circ$  1

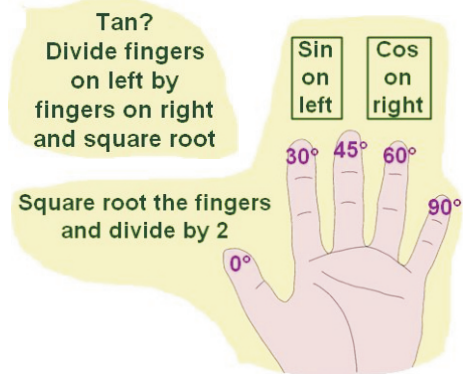

2) Write down the exact values of:

- a)  $\cos 0^\circ$  1  
 b)  $\cos 30^\circ$   $\frac{\sqrt{3}}{2}$   
 c)  $\cos 45^\circ$   $\frac{\sqrt{2}}{2}$   
 d)  $\cos 60^\circ$  0.5  
 e)  $\cos 90^\circ$  0

3) Write down the exact values of:

- a)  $\tan 0^\circ$  0  
 b)  $\tan 30^\circ$   $\frac{1}{\sqrt{3}}$   
 c)  $\tan 45^\circ$  1  
 d)  $\tan 60^\circ$   $\sqrt{3}$



- 1) The translation of triangle  $P$  to triangle  $Q$  is described by column vector  $\mathbf{v}$ .

Write down  $\mathbf{v}$ .  $\begin{bmatrix} -7 \\ -3 \end{bmatrix}$

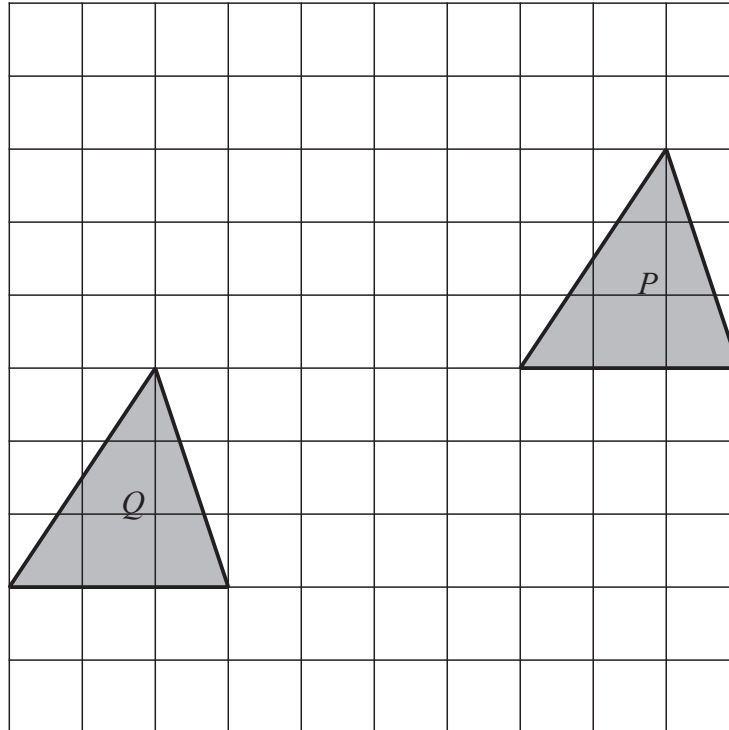

- 2) Here are two column vectors:  $\mathbf{f} = \begin{bmatrix} -2 \\ 5 \end{bmatrix}$        $\mathbf{g} = \begin{bmatrix} 3 \\ -1 \end{bmatrix}$

Work out

a)  $2\mathbf{f}$

b)  $-\mathbf{g}$

c)  $\mathbf{f} + \mathbf{g}$

d)  $\mathbf{f} - \mathbf{g}$

e)  $2\mathbf{f} + 4\mathbf{g}$

f)  $3\mathbf{g} - \mathbf{f}$

a)  $\begin{bmatrix} -4 \\ 10 \end{bmatrix}$

b)  $\begin{bmatrix} -3 \\ 1 \end{bmatrix}$

c)  $\begin{bmatrix} 1 \\ 4 \end{bmatrix}$

d)  $\begin{bmatrix} -5 \\ 6 \end{bmatrix}$

e)  $\begin{bmatrix} 8 \\ 6 \end{bmatrix}$

f)  $\begin{bmatrix} 11 \\ -8 \end{bmatrix}$

## Harder Tree Diagrams

- 1) There are 5 red pens, 3 blue pens and 2 green pens in a box.  
Jerry takes at random a pen from the box and gives the pen to his friend.  
Jerry then takes at random another pen from the box.  
Work out the probability that both pens are the same colour.  $\frac{28}{90}$



- 2) There are 3 red sweets, 2 blue sweets and 4 green sweets in a bag.  
Jack takes a sweet at random.  
He eats the sweet.  
He then takes another sweet at random.

Work out the probability that both sweets are the same colour.  $\frac{20}{72}$



- 3) There are 13 buttons in a bag.  
9 buttons are white.  
4 buttons are black.  
Carol takes a button at random from the bag, and keeps it.  
She now takes another button from the bag.

Work out the probability that Carol takes a button of each colour.  $\frac{72}{156}$

## Harder Tree Diagrams

- 1) A bag contains 7 green and 3 yellow balls.  
A ball is taken from the bag at random and not replaced.  
Another ball is taken from the bag at random.

- a) Draw a tree diagram to show all the possibilities.  
b) What is the probability that both balls are different colours?  
 $\frac{42}{90}$

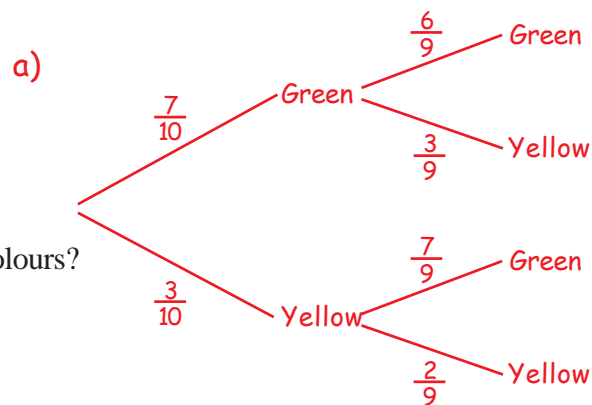

- 2) A box contains 5 red counters and 3 blue counters.  
A counter is taken from the box at random and not replaced.  
Another counter is taken at random.

- a) Draw a tree diagram to show all the possibilities.  
b) What is the probability of choosing at least one blue counter?  $\frac{36}{56}$   
c) What is the probability of choosing two counters of the same colour?  $\frac{26}{56}$   
d) What is the probability of choosing two counters of different colours?  $\frac{30}{56}$

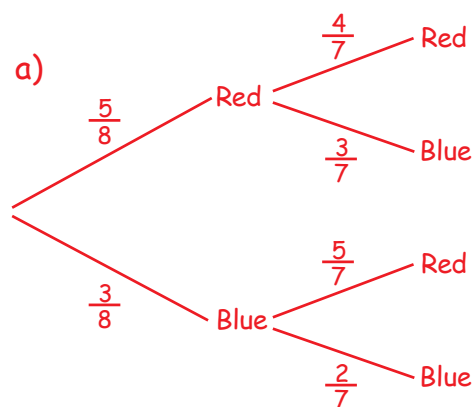

- 3) A box contains 4 red counters and 3 blue counters.  
A counter is taken from the box at random and not replaced.  
A second counter is taken from the box at random and not replaced.  
A third counter is taken from the box.

- a) Draw a tree diagram to show all the possibilities.  
b) What is the probability that all three counters are the same colour?  $\frac{30}{210}$   
c) What is the probability that exactly two of the counters are red?  $\frac{108}{210}$

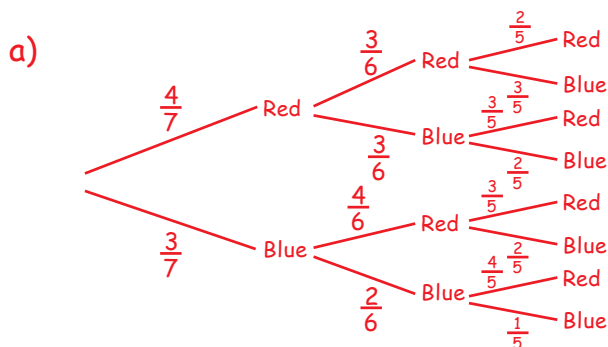

### Harder Tree Diagrams

- 1) Sara has two boxes.  
There are 6 black and 4 white counters in box A.  
There are 7 black and 3 white counters in box B.

Sara takes at random a counter from box A and puts it in box B.  
She then takes at random a counter from box B and puts it in box A.

- a) Complete the probability tree diagram.

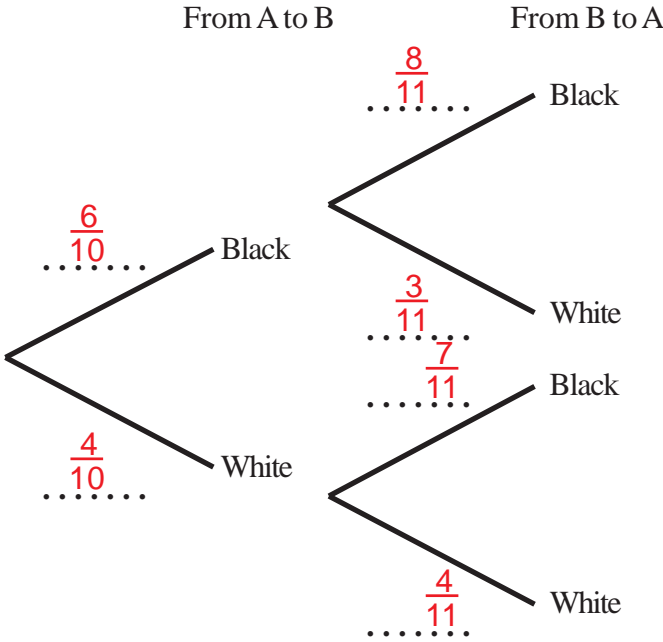

- b) Find the probability that after Sara has put the counters from box B into box A there will still be 6 black counters and 4 white counters in box A.  $\frac{64}{110}$

## Stratified Sampling



- 1) Ellen wants to do a survey with Years 9, 10 and 11 at her school.  
The table shows the number of students in each of these year groups.

Year 11	Year 10	Year 9
750	700	900

Ellen takes a sample of 50 students stratified by year group.

Work out the number of students from Year 10 in the sample. **15**



- 2) The table shows information about the year groups of 1000 students in a school.

Year group	7	8	9	10	11	12	13
Number in year	157	180	166	140	132	114	111

Tony takes a sample of 50 of these students, stratified by year group.

Calculate the number of Year 8 students he should have in his sample. **9**



- 3) The table shows information about Ben's collection of 652 coins.

Country	France	Spain	Germany	Italy	Total
Number of coins	240	182	133	97	652

Ben takes a sample of 50 coins stratified by country.

Work out the number of coins from Italy in this sample. **7**



- 4)

	Male	Female
Lower sixth	399	602
Upper sixth	252	198

The table gives information about the number of students in the two years of a sixth form.

Amy wants to interview some of these students.

She takes a random sample of 70 students stratified by year and by gender.

Work out the number of students in the sample who are male and in the lower sixth. **19**

## Stratified Sampling



- 1) The table below shows the number of employees in each section of a company.

Department	Managerial	Sales	Technical	Production
Number of employees	18	45	288	549

A survey on job satisfaction is to be carried out.

- a) Explain why a simple random sample of employees is unsuitable. **The numbers in the different types of jobs vary greatly.**
- b) A stratified random sample of 100 is used. Complete the table below to show how many employees from each department will be included.

Department	Managerial	Sales	Technical	Production
Number of employees in sample	2	5	32	61



- 2) MathsWatch High-School has 798 pupils.
- 
- The size of each year group is shown below.

Year Group	Boys	Girls
7	77	72
8	74	79
9	72	74
10	93	107
11	85	65

The headteacher wants to find out the opinions of the pupils on changing the timing of the school day. A stratified sample of 80 pupils is taken.

- a) Complete the table below to show the numbers of pupils to be sampled.

Year Group	Boys in Sample	Girls in Sample
7	8	7
8	7	8
9	7	7
10	9	11
11	9	7

The table below shows the number of pupils in the sample who answered YES to a change in the timing of the school day.

Year Group	Boys in Sample who answered YES	Girls in Sample who answered YES
7	2	3
8	3	5
9	2	1
10	1	4
11	0	1

- b) Use the table to estimate the percentage of pupils in the school who would answer YES to the question.
- 27.5%**

Write each recurring decimal as an exact fraction,  
in its lowest terms.

a)  $0.\dot{5}$        $\frac{5}{9}$

b)  $0.\dot{7}$        $\frac{7}{9}$

c)  $0.\dot{4}$        $\frac{4}{9}$

d)  $0.\dot{2}\dot{4}$        $\frac{8}{33}$

e)  $0.\dot{7}\dot{5}$        $\frac{25}{33}$

f)  $0.\dot{8}\dot{2}$        $\frac{82}{99}$

g)  $0.\dot{6}1\dot{7}$        $\frac{617}{999}$

h)  $0.\dot{2}1\dot{6}$        $\frac{8}{37}$

i)  $0.\dot{7}1\dot{4}$        $\frac{238}{333}$

j)  $0.\dot{3}2\dot{4}$        $\frac{12}{37}$

k)  $0.\dot{7}235\dot{7}$        $\frac{89}{123}$

l)  $0.\dot{6}521\dot{4}$        $\frac{7246}{11111}$

1) Expand and simplify:

a)  $x(x + 2)(x + 3)$   $x^3 + 5x^2 + 6x$

b)  $x(x + 4)(x + 7)$   $x^3 + 11x^2 + 28x$

c)  $x(x + 1)(x + 9)$   $x^3 + 10x^2 + 9x$

2) Expand and simplify:

a)  $x(x + 5)(x - 2)$   $x^3 + 3x^2 - 10x$

b)  $x(x - 4)(x + 3)$   $x^3 - x^2 - 12x$

c)  $x(x + 8)(x - 3)$   $x^3 + 5x^2 - 24x$

3) Expand and simplify:

a)  $(x + 1)(x + 5)(x + 2)$   $x^3 + 8x^2 + 17x + 10$

b)  $(x - 3)(x - 2)(x - 1)$   $x^3 - 6x^2 + 11x - 6$

c)  $(x - 2)(x + 5)(x - 1)$   $x^3 + 2x^2 - 13x + 10$

4) Expand and simplify:

a)  $(x - 4)(x + 4)(x - 2)$   $x^3 - 2x^2 - 16x + 32$

b)  $(x - 3)(x - 1)(x + 3)$   $x^3 - x^2 - 9x + 9$

c)  $(x + 6)(x + 2)(x - 6)$   $x^3 + 2x^2 - 36x - 72$

5) Expand and simplify:

a)  $(2x - 1)(x + 3)(x + 1)$   $2x^3 + 7x^2 + 2x - 3$

b)  $(x + 5)(2x - 3)(3x + 1)$   $6x^3 + 23x^2 - 38x - 15$

c)  $(2x - 1)(3x - 2)(4x - 3)$   $24x^3 - 46x^2 + 29x - 6$



## Iteration - Trial and Improvement



1) The equation

$$x^3 - x = 29$$

has a solution between 3 and 4

Use a trial and improvement method to find this solution.

Give your answer correct to 1 decimal place.

You must show **all** your working.

$x = 3$

$x = 4$

$x = 3.1$

$x = 3.2$

$x = 3.15$

$$x^3 - x = 29$$

$3^3 - 3 = 24$

$4^3 - 4 = 60$

$3.1^3 - 3.1 = 26.691$

$3.2^3 - 3.2 = 29.568$

$3.15^3 - 3.15 = 28.105875$

too low

too high

too low

too high

too low

Therefore,  $x = 3.2$  to 1 decimal place.



2) The equation

$$x^3 - 4x = 25$$

has a solution between 3 and 4

Use a trial and improvement method to find this solution.

Give your answer correct to 1 decimal place.

You must show **all** your working.

$x = 3$

$x = 4$

$x = 3.4$

$x = 3.3$

$x = 3.35$

$$x^3 - 4x = 25$$

$3^3 - 4 \times 3 = 15$

$4^3 - 4 \times 4 = 48$

$3.4^3 - 4 \times 3.4 = 25.704$

$3.3^3 - 4 \times 3.3 = 22.737$

$3.35^3 - 4 \times 3.35 = 24.195375$

too low

too high

too high

too low

too low

Therefore,  $x = 3.4$  to 1 decimal place.



3) The equation

$$x^3 - 2x = 68$$

has a solution between 4 and 5

Use a trial and improvement method to find this solution.

Give your answer correct to 1 decimal place.

You must show **all** your working.

$x = 4$

$x = 5$

$x = 4.2$

$x = 4.3$

$x = 4.25$

$$x^3 - 2x = 68$$

$4^3 - 2 \times 4 = 56$

$5^3 - 2 \times 5 = 115$

$4.2^3 - 2 \times 4.2 = 65.688$

$4.3^3 - 2 \times 4.3 = 70.907$

$4.25^3 - 2 \times 4.25 = 68.265625$

too low

too high

too low

too high

too high

Therefore,  $x = 4.2$  to 1 decimal place.



4) The equation

$$x^3 + 4x = 101$$

has one solution which is a positive number.

Use a trial and improvement method to find this solution.

Give your answer correct to 1 decimal place.

You must show **all** your working.

$x = 3$

$x = 4$

$x = 5$

$x = 4.2$

$x = 4.3$

$x = 4.4$

$x = 4.35$

$$x^3 + 4x = 101$$

$3^3 + 4 \times 3 = 39$

$4^3 + 4 \times 4 = 80$

$5^3 + 4 \times 5 = 145$

$4.2^3 + 4 \times 4.2 = 90.888$

$4.3^3 + 4 \times 4.3 = 96.707$

$4.4^3 + 4 \times 4.4 = 102.784$

$4.35^3 + 4 \times 4.35 = 99.712875$

too low

too low

too high

too low

too low

too high

too low

Therefore,  $x = 4.4$  to 1 decimal place.

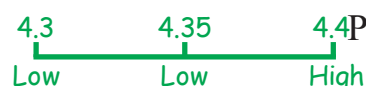



- 1) A sequence is defined by the term-to-term rule

$$u_{n+1} = u_n^2 - 3u_n$$

Given that  $u_1 = 2$ , find  $u_2$ ,  $u_3$  and  $u_4$ . **-2, 10, 70**



- 2) A sequence is defined by the term-to-term rule

$$x_{n+1} = \frac{x_n - 1}{1 + 3x_n}$$

Given that  $x_1 = 3$ , find  $x_2$ ,  $x_3$  and  $x_4$ . **0.2, -0.5, 3**



- 3)  $x_{n+1} = 4 - \frac{1}{x_n}$

Use a starting value of  $x_1 = 1$  to find a solution to  $x_{n+1} = 4 - \frac{1}{x_n}$  to 1 decimal place. **3.7**



- 4)  $x_{n+1} = 3 + \frac{2}{x_n^2}$

Use a starting value of  $x_1 = 1$  to find a solution to  $x_{n+1} = 3 + \frac{2}{x_n^2}$  to 1 decimal place. **3.2**

## Enlargement - Negative Scale Factor

- 1) Enlarge triangle T by scale factor  $-2$  using coordinates  $(2, 2)$  as the centre of enlargement.

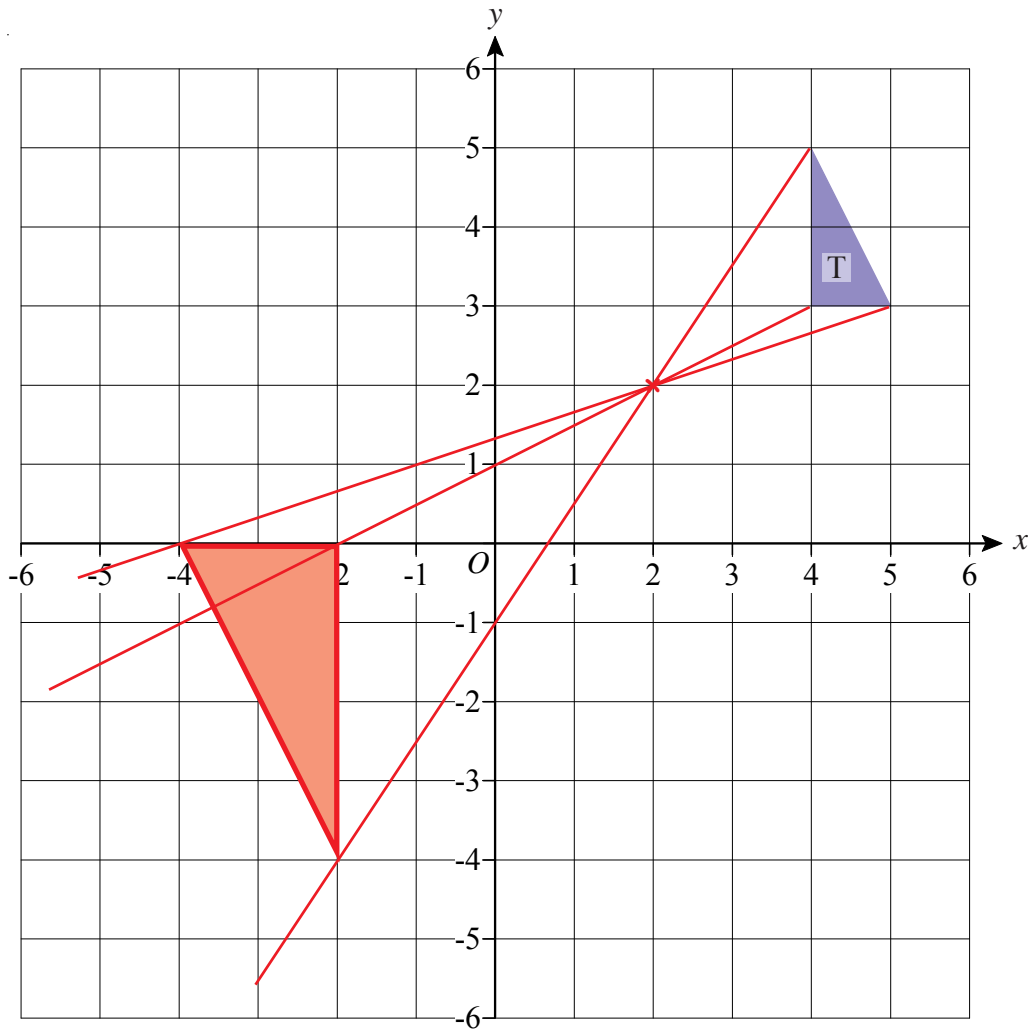

- 2) Describe fully the single transformation which maps triangle T to triangle U.

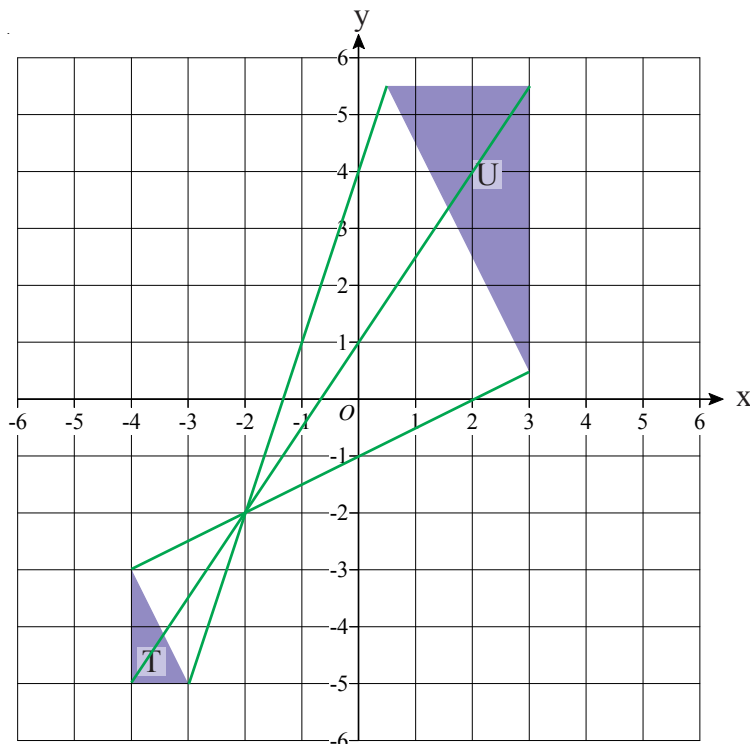

Enlargement with scale factor  $-2.5$   
Centre of enlargement at  $(-2, -2)$

## Combinations of Transformations

1)

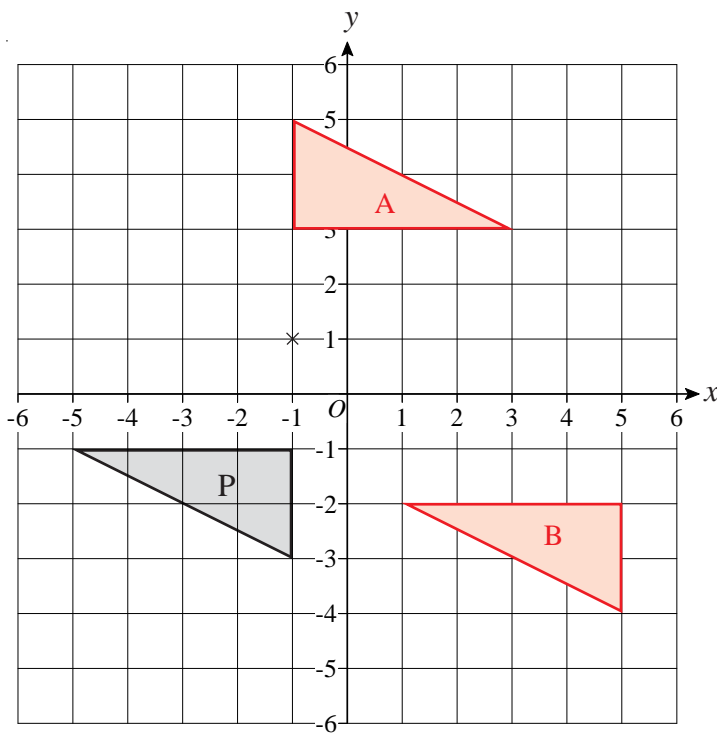

a) Rotate triangle P  $180^\circ$  about the point  $(-1, 1)$ .  
Label the new triangle A.

b) Translate triangle P by the vector  $\begin{pmatrix} 6 \\ -1 \end{pmatrix}$   
Label the new triangle B.

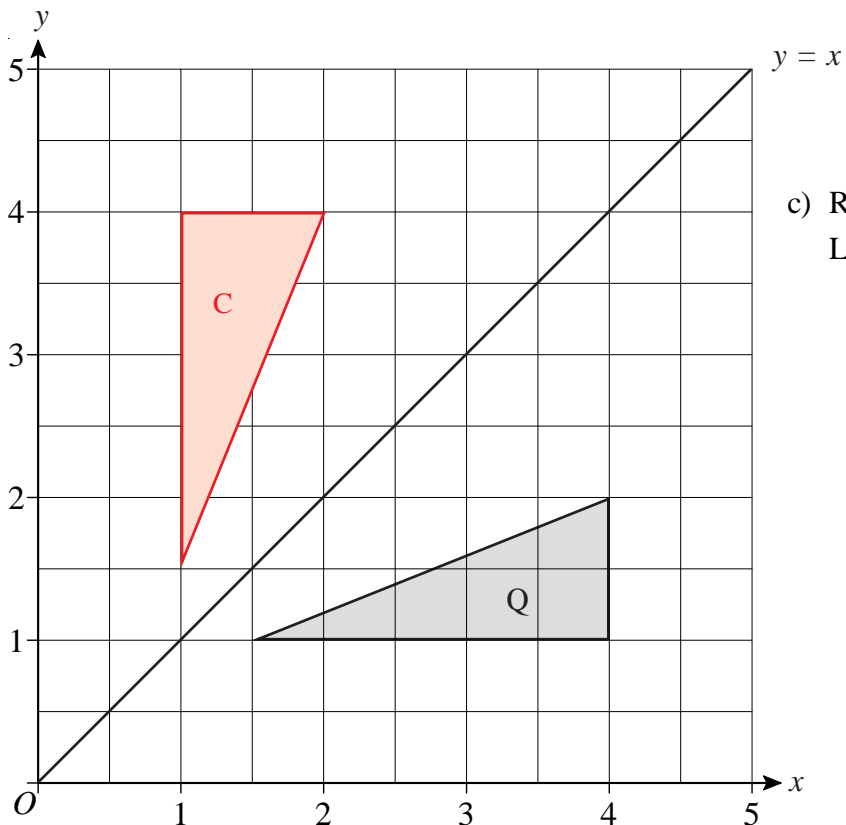

c) Reflect triangle Q in the line  $y = x$ .  
Label the new triangle C.

## Combinations of Transformations

1)

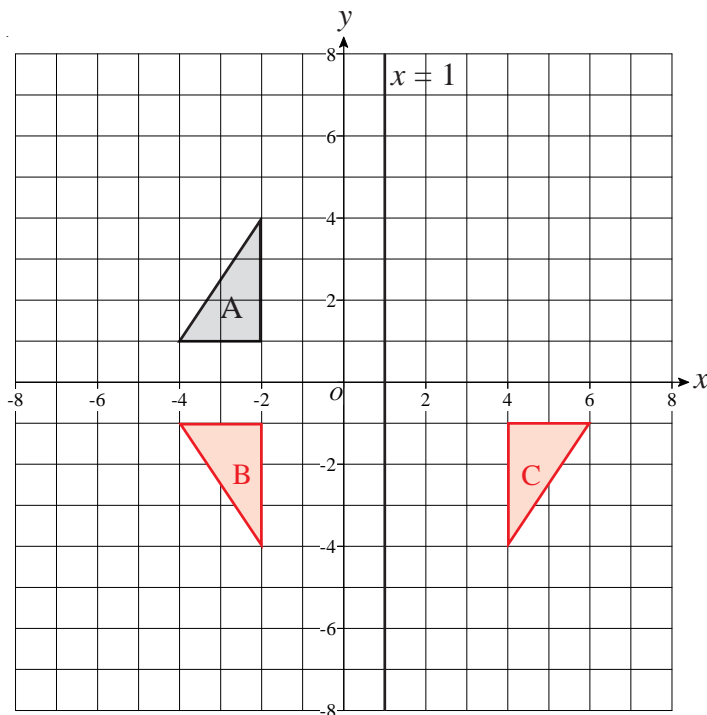

Triangle A is reflected in the  $x$ -axis to give triangle B.

Triangle B is reflected in the line  $x = 1$  to give triangle C.

Describe fully the **single** transformation that takes triangle A to triangle C.

**Rotation of  $180^\circ$  about the point  $(1, 0)$**

2)

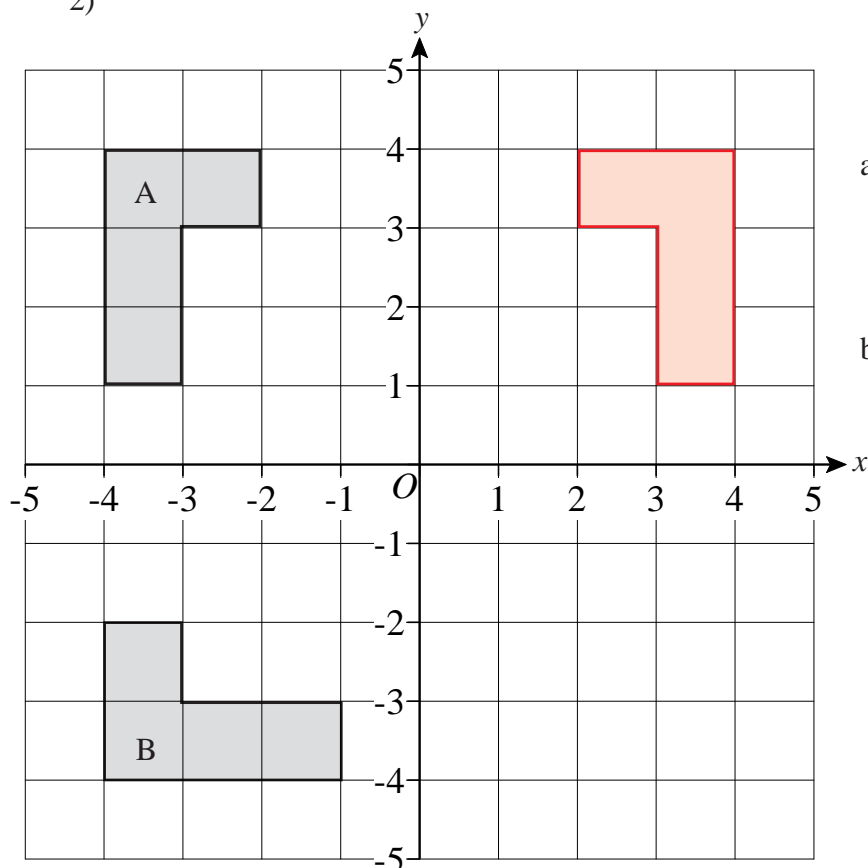

a) Reflect shape A in the  $y$ -axis.

b) Describe fully the **single** transformation which takes shape A to shape B.

**Rotation of  $90^\circ$  anticlockwise about the point  $(0, 0)$**

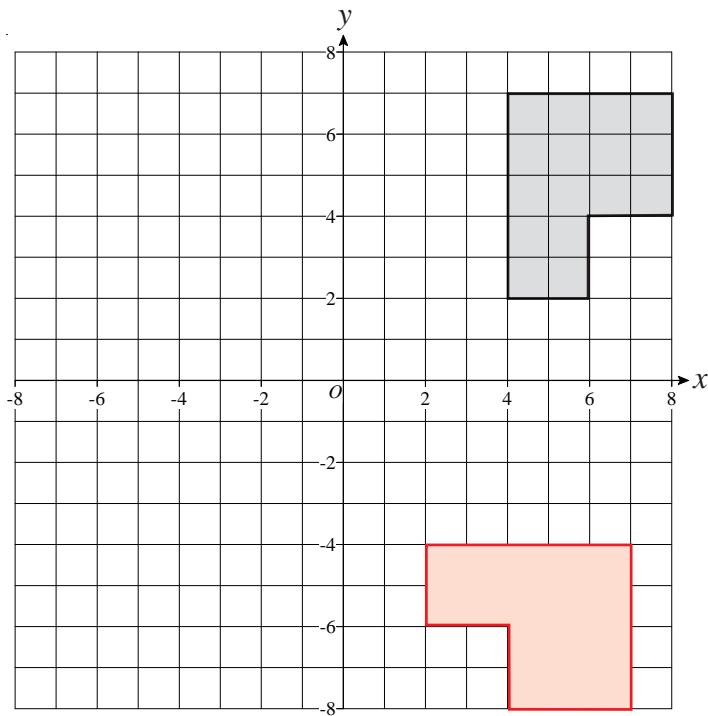

a) Rotate the shaded shape  $90^\circ$  clockwise about the point  $O$ .

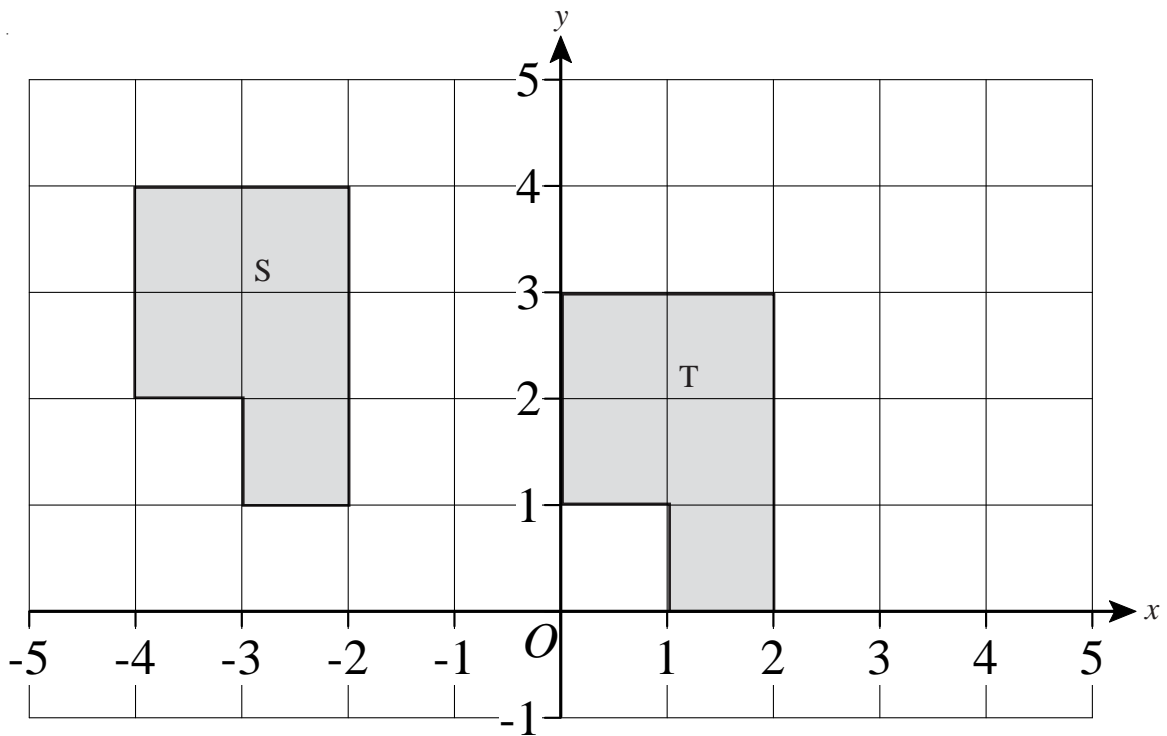

b) Describe fully the single transformation that will map shape S onto shape T.

Translate shape S by the vector  $\begin{pmatrix} 4 \\ -1 \end{pmatrix}$

1)

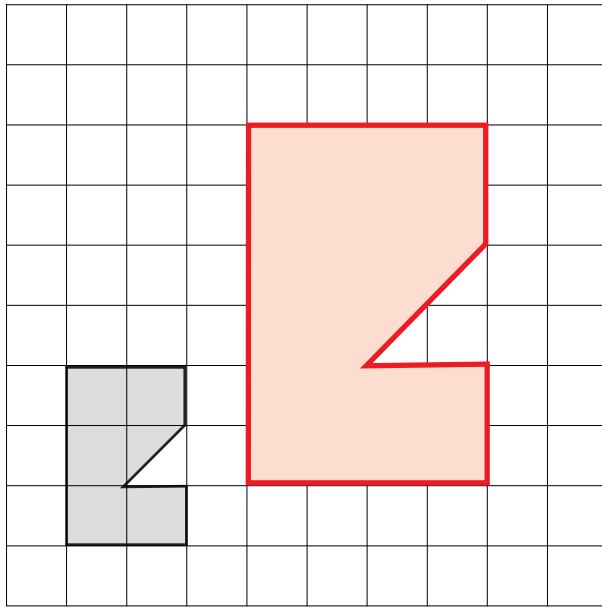

a) On the grid, draw an enlargement, scale factor 2, of the shaded shape.

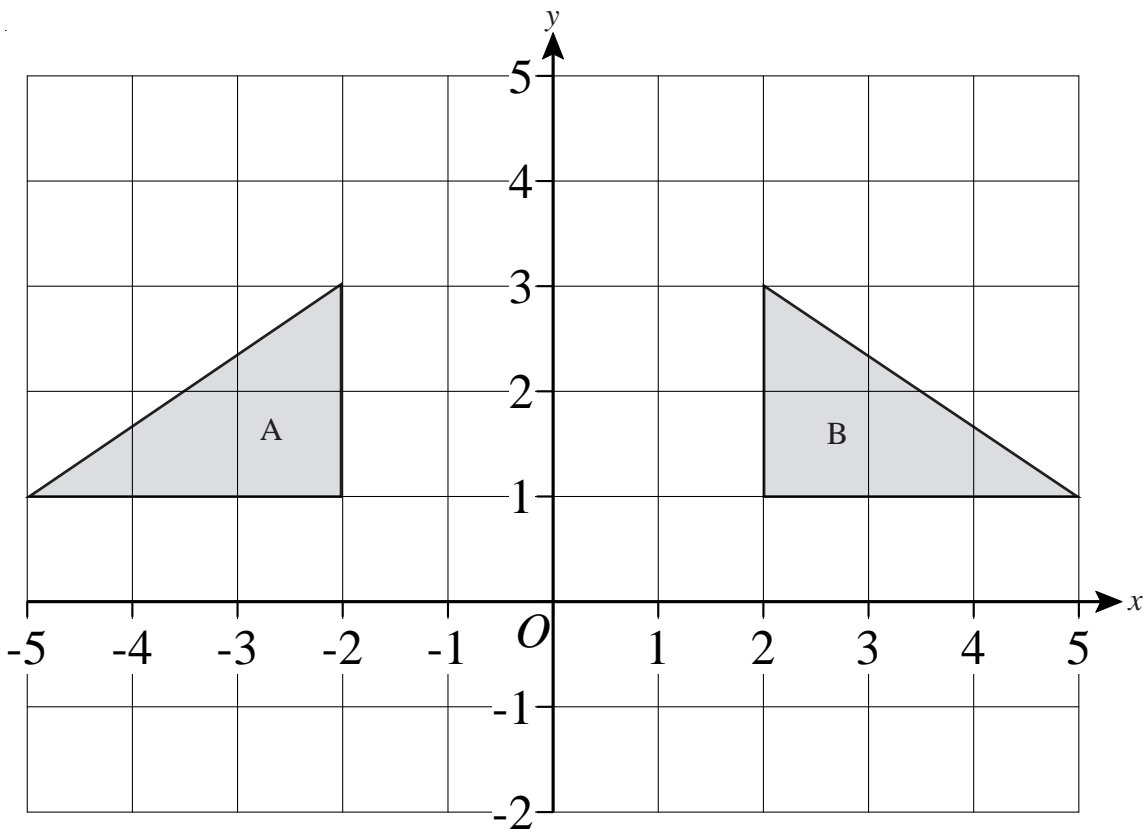

b) Describe fully the single transformation that maps triangle A onto triangle B.

Reflection in the y-axis

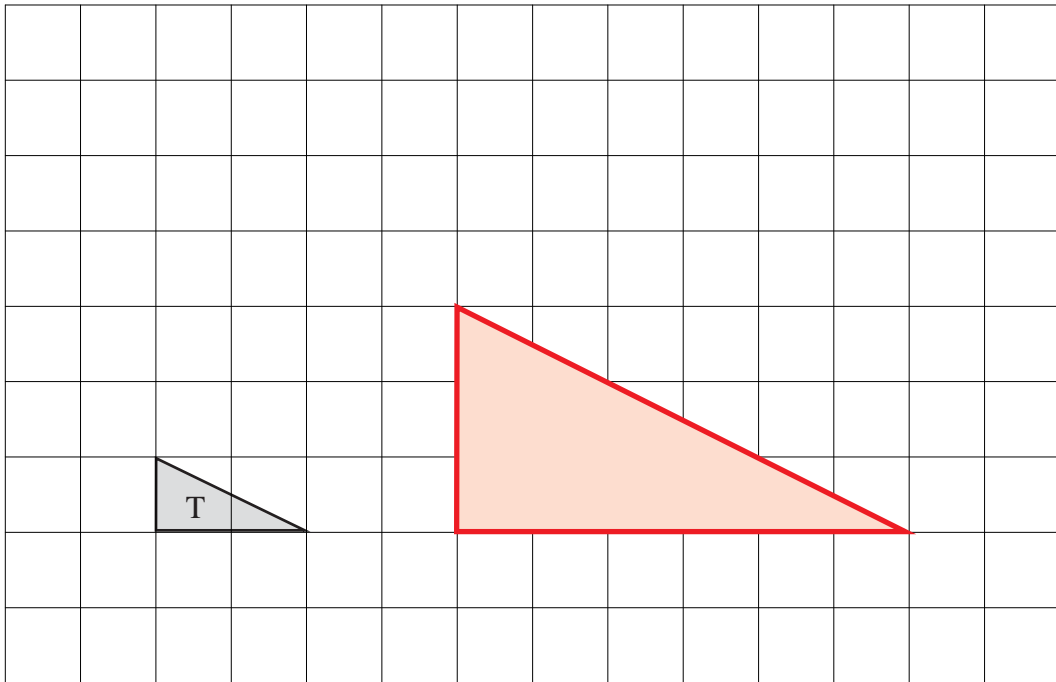

Triangle T has been drawn on a grid.

- a) On the grid, draw an enlargement of the triangle T with scale factor 3.

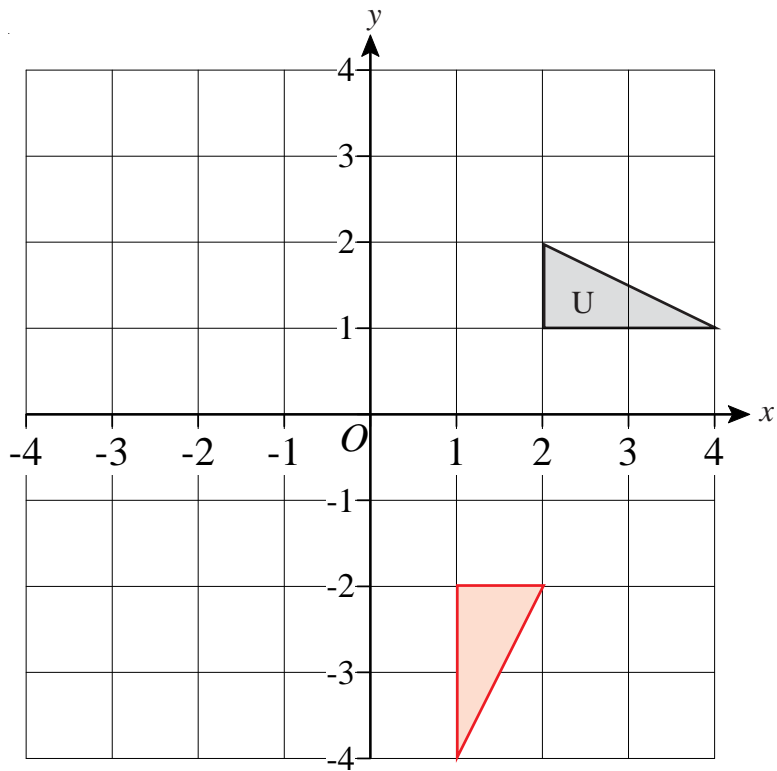

Triangle U has been drawn on a grid.

- b) On the grid, rotate triangle U  $90^\circ$  clockwise about the centre  $O$ .



1)

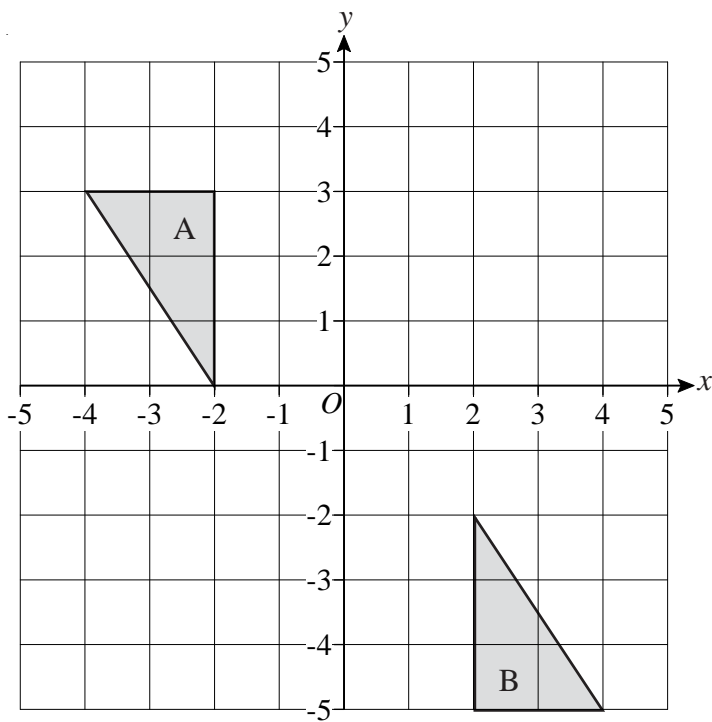

Describe fully the single transformation that maps triangle A onto triangle B.

Rotation of  $180^\circ$  about the point  $(0, -1)$

2)

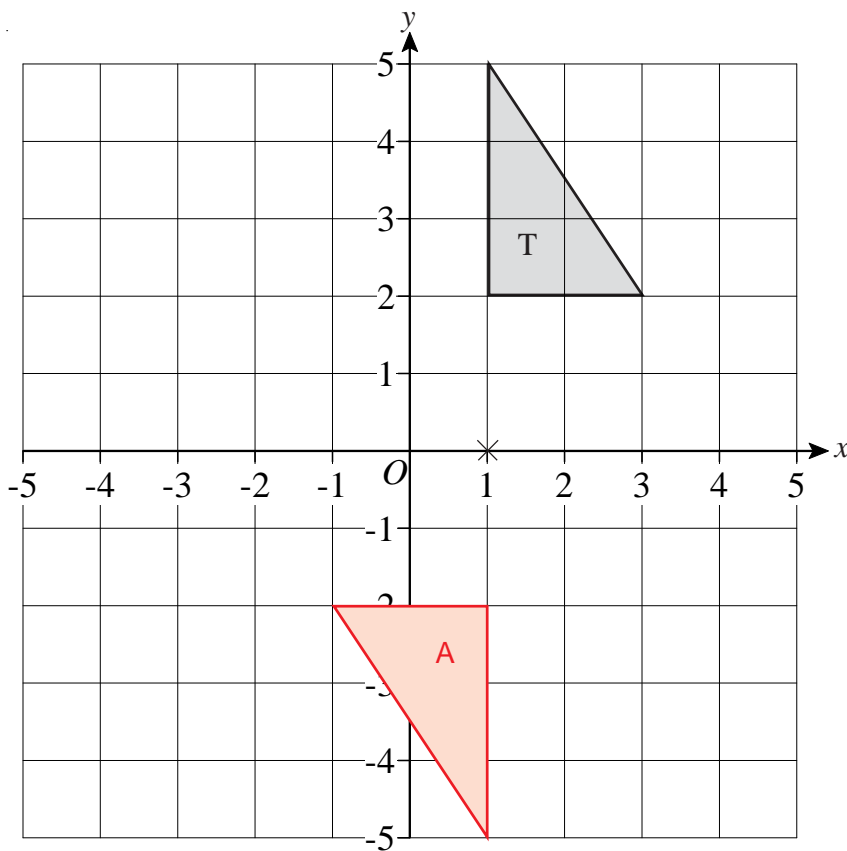

Triangle T has been drawn on the grid.

Rotate triangle T  $180^\circ$  about the point  $(1, 0)$

Label the new triangle A.

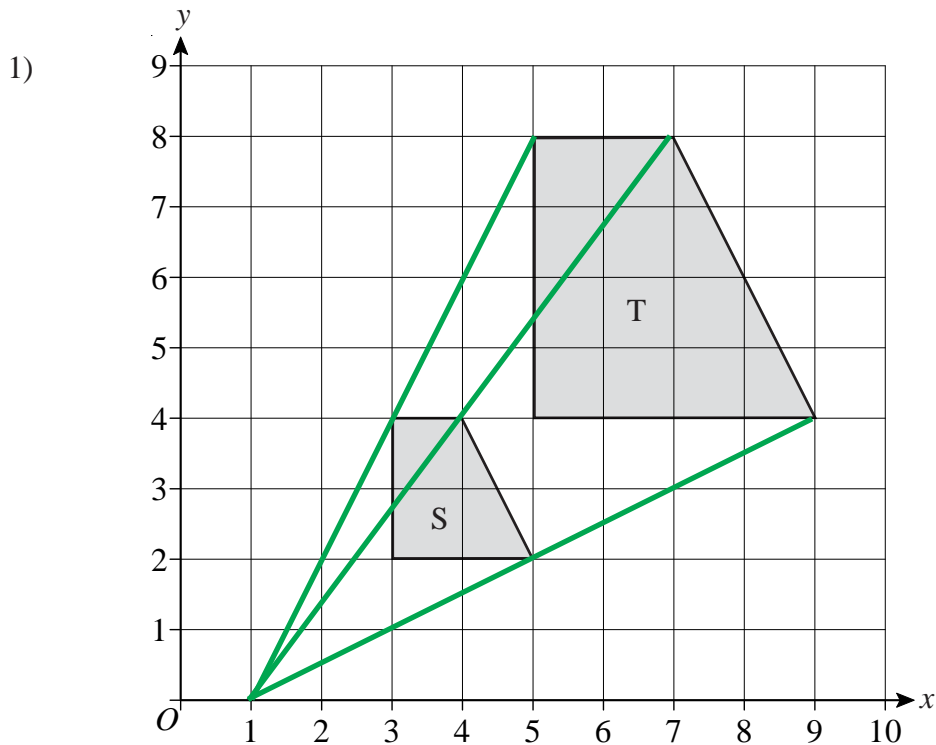

Describe fully the single transformation which maps shape S onto shape T.  
**Enlargement scale factor 2 with (1, 0) as the centre of enlargement.**

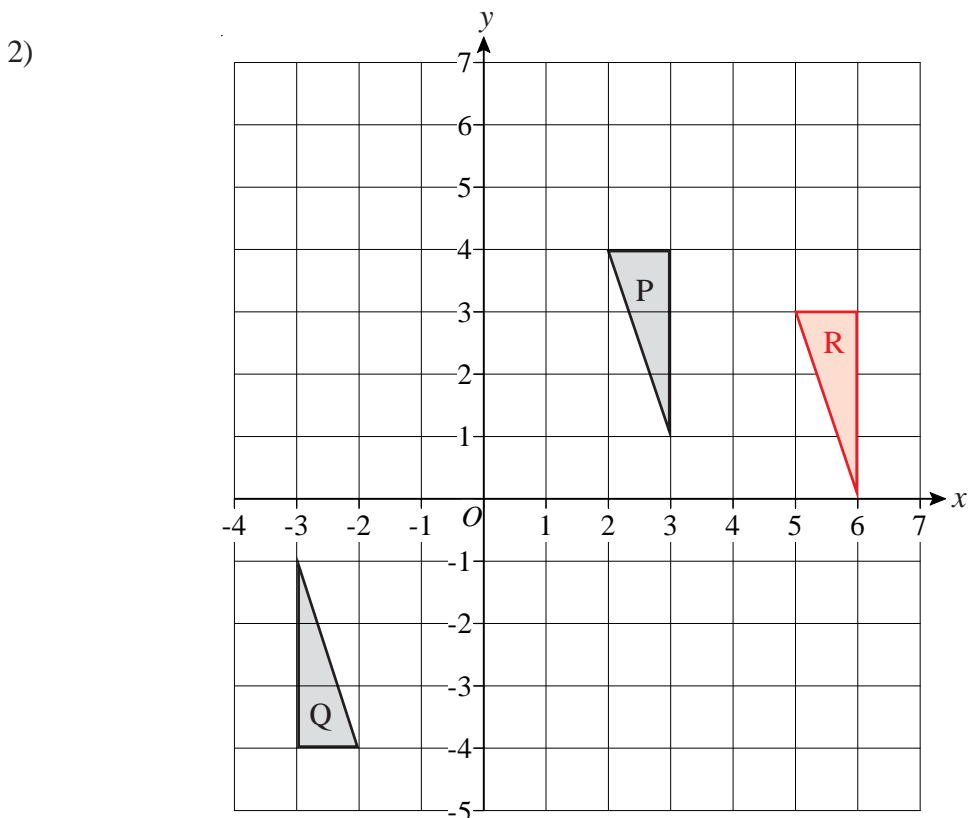

Triangle P and triangle Q are drawn on the grid.

- Describe fully the single transformation which maps triangle P onto triangle Q.  
**Rotation of 180° about the point (0, 0)**
- Translate triangle P by the vector  $\begin{pmatrix} 3 \\ -1 \end{pmatrix}$   
 Label the new triangle R.

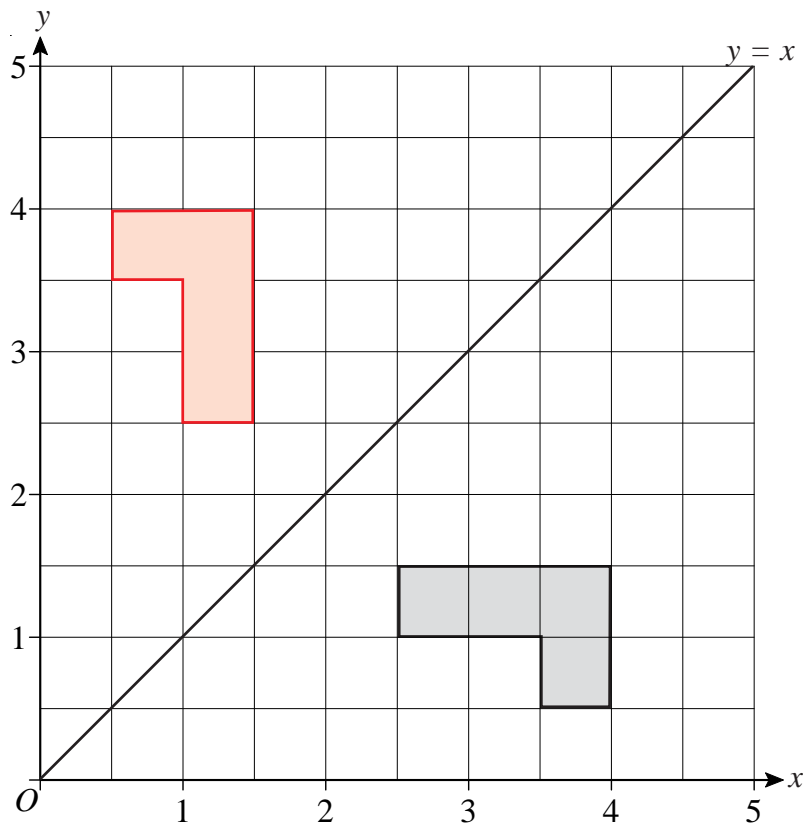

a) Reflect the shaded shape in the line  $y = x$ .

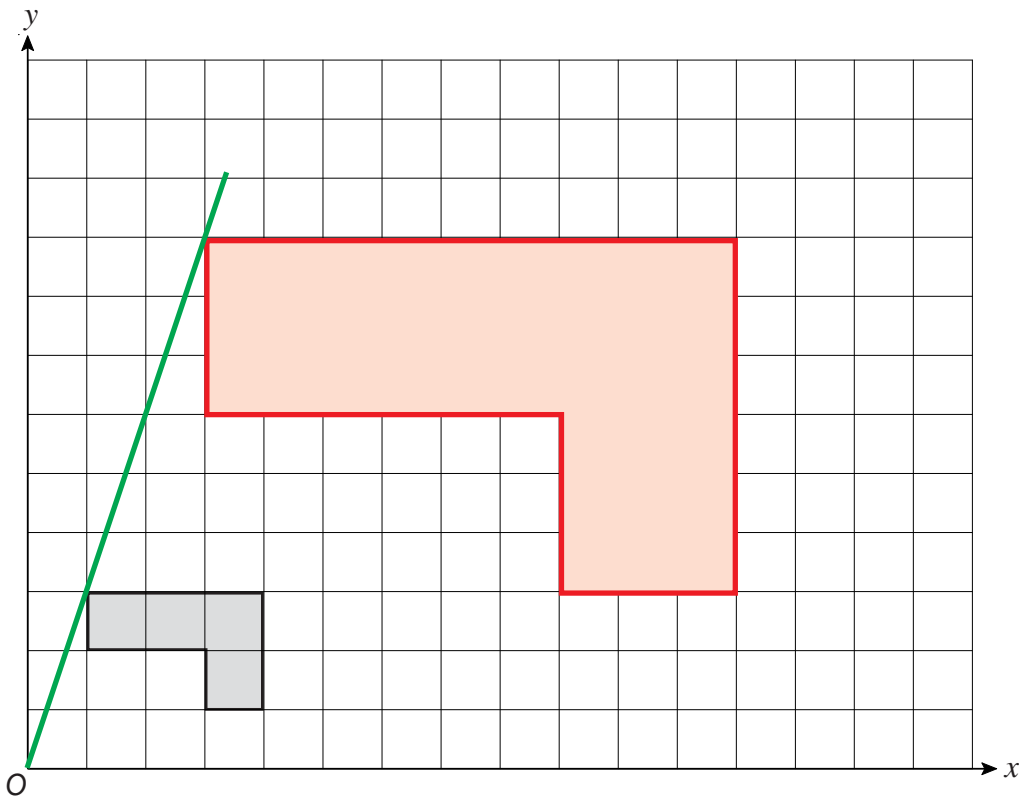

b) On the grid, enlarge the shaded shape by a scale factor of 3, centre  $O$ .

## Combinations of Transformations

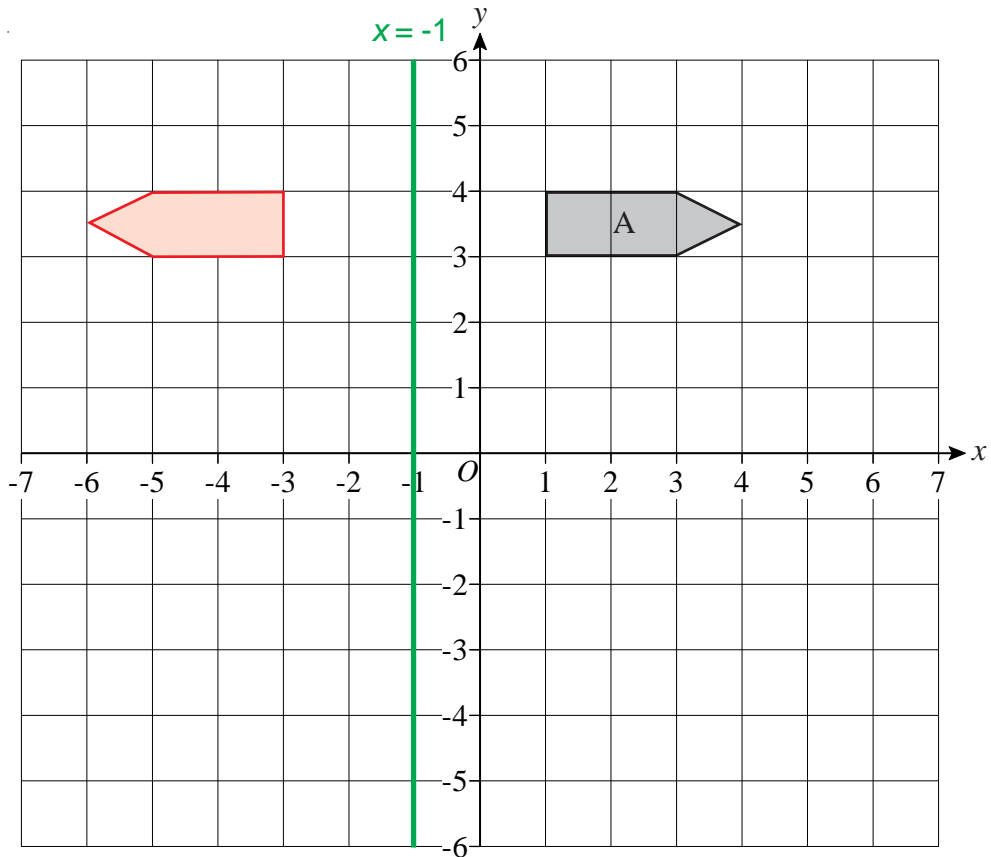

- a) On the grid above, reflect shape A in the line  $x = -1$

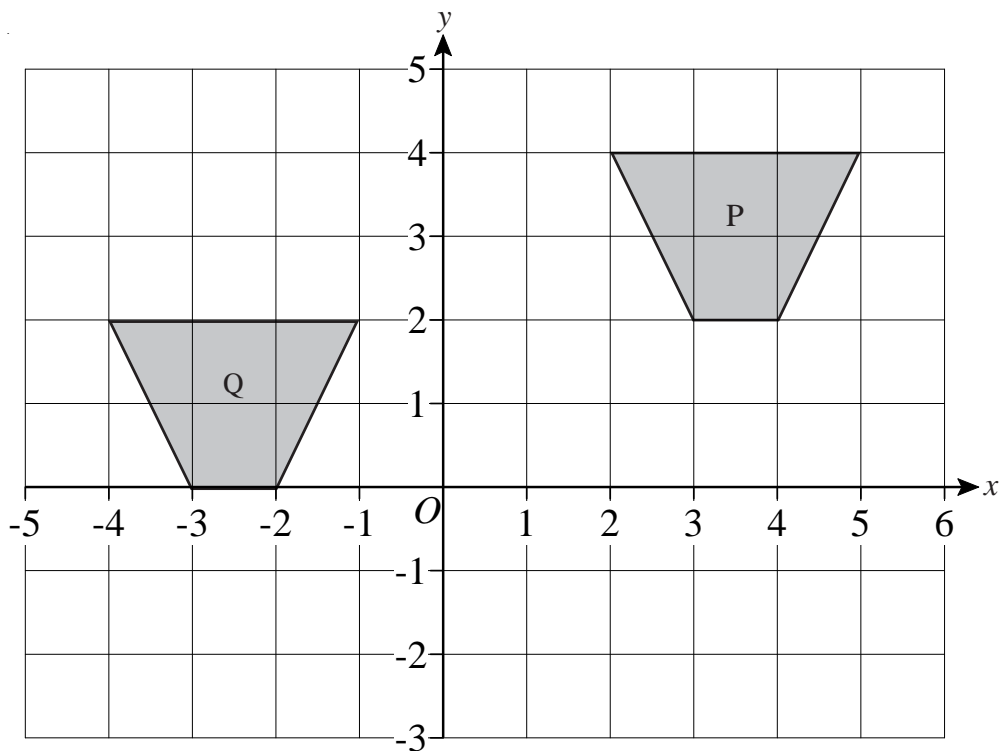

- b) Describe fully the single transformation that will map shape P onto shape Q.

Translation by vector  $\begin{pmatrix} -6 \\ -2 \end{pmatrix}$

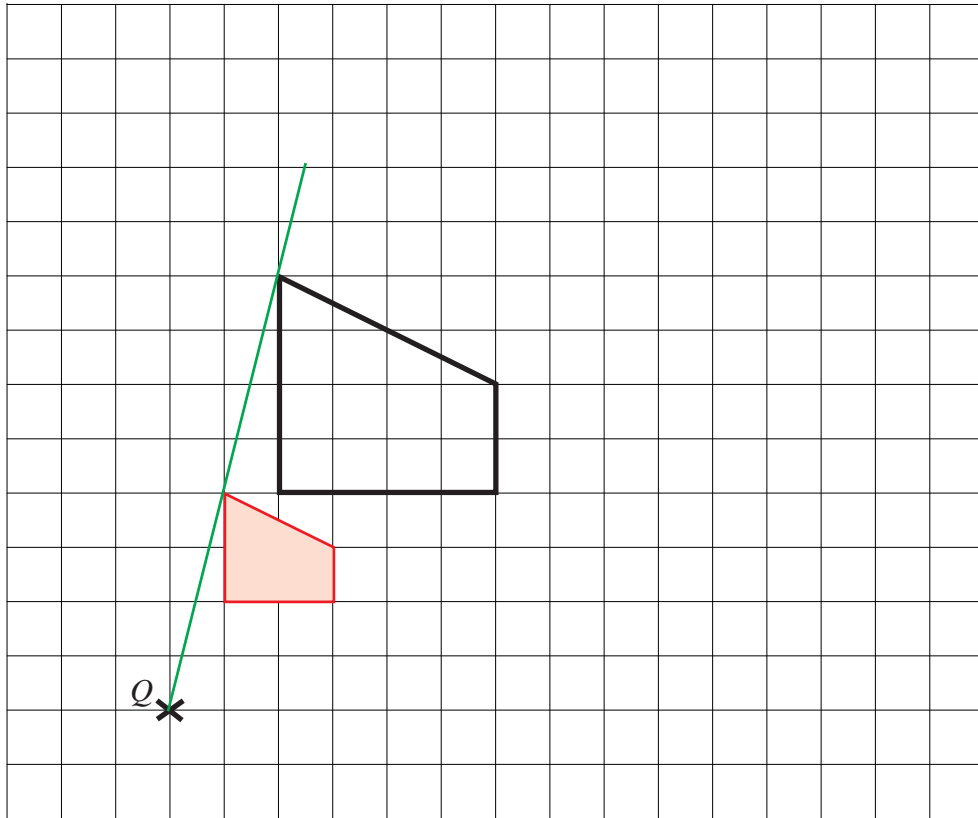

- a) On the grid, enlarge the shape with scale factor  $\frac{1}{2}$ , centre  $Q$ .

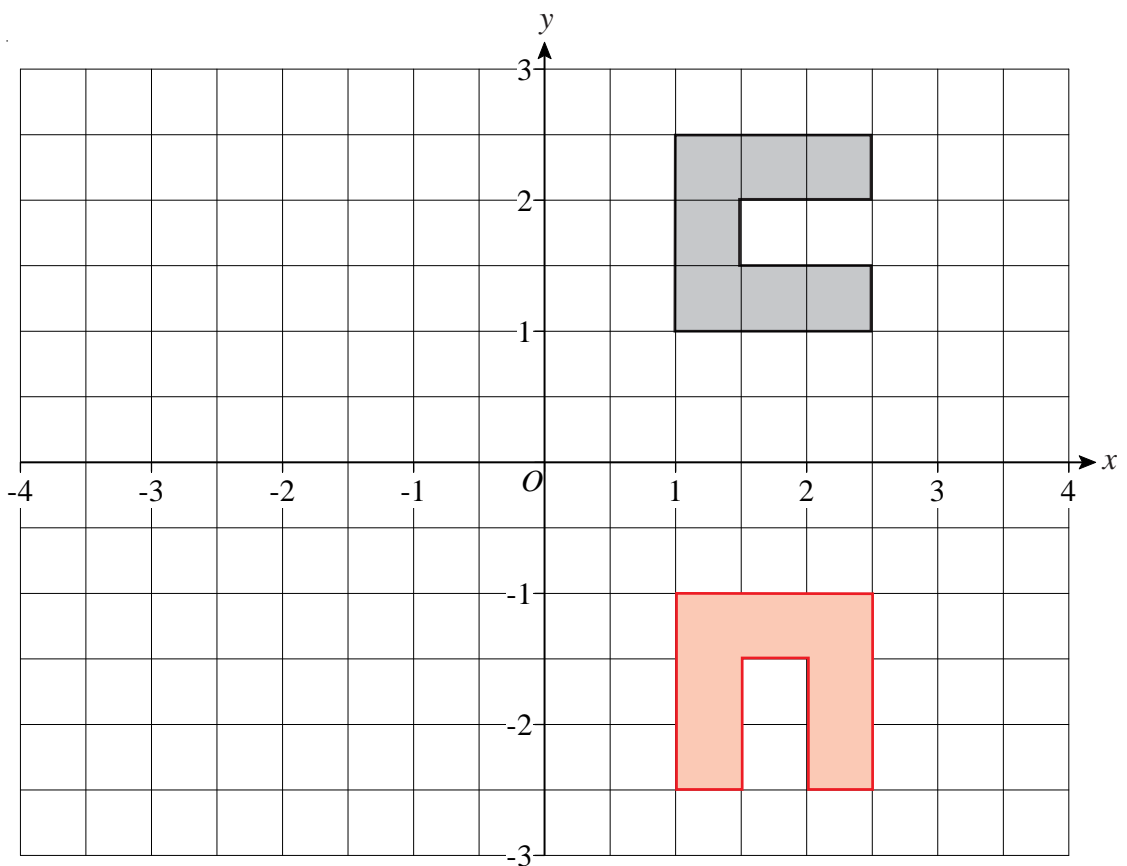

- b) Rotate the shape  $90^\circ$  clockwise, centre  $O$ .

1)

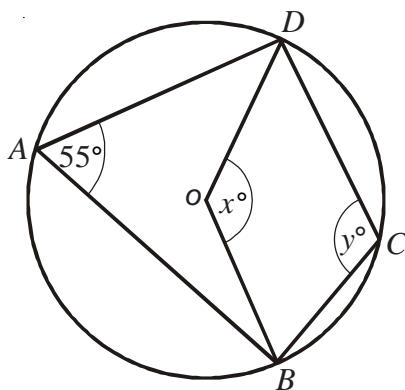

In the diagram,  $A$ ,  $B$ ,  $C$ , and  $D$  are points on the circumference of a circle, centre  $O$ .

Angle  $BAD = 55^\circ$ .

Angle  $BOD = x^\circ$ .

Angle  $BCD = y^\circ$ .

a) (i) Work out the value of  $x$ .  **$110^\circ$**

(ii) Give a reason for your answer.

**Angle at centre of circle is twice the angle on the circumference**

b) (i) Work out the value of  $y$ .  **$125^\circ$**

(ii) Give a reason for your answer.

**Opposite angles of cyclic quadrilateral add up to  $180^\circ$**

2)

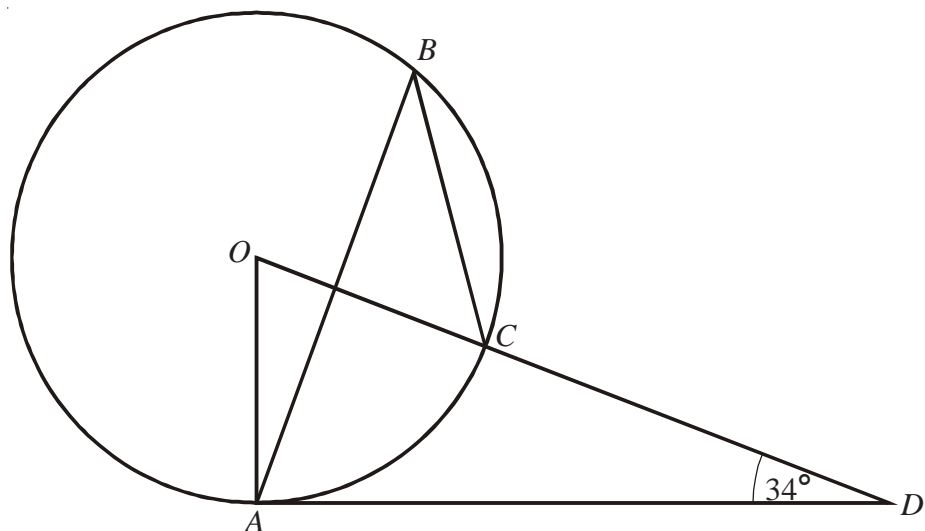

The diagram shows a circle centre  $O$ .

$A$ ,  $B$  and  $C$  are points on the circumference.

$DCO$  is a straight line and  $DA$  is a tangent to the circle.

Angle  $ADO = 34^\circ$

a) Work out the size of angle  $AOD$ .  **$56^\circ$**

b) (i) Work out the size of angle  $ABC$ .  **$28^\circ$**

(ii) Give a reason for your answer.

**Angle at centre of circle is twice the angle on the circumference**

1)

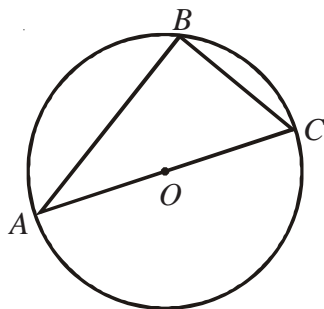

$A$ ,  $B$  and  $C$  are points on the circumference of a circle centre  $O$ .  
 $AC$  is a diameter of the circle.

- a) (i) Write down the size of angle  $ABC$ .  $90^\circ$   
 (ii) Give a reason for your answer.  
**Angle in a semi-circle is  $90^\circ$**

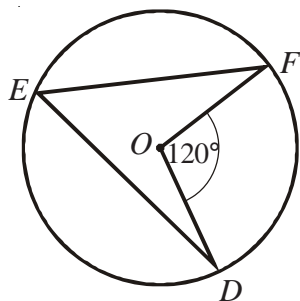

$D$ ,  $E$  and  $F$  are points on the circumference of a circle, centre  $O$ .  
 Angle  $DOF = 120^\circ$ .

- b) (i) Work out the size of angle  $DEF$ .  $60^\circ$   
 (ii) Give a reason for your answer.  
**Angle at centre of circle is twice the angle on the circumference**

- 2)  $B$ ,  $D$  and  $E$  are points on a circle centre  $O$ .  
 $ABC$  is a tangent to the circle.  
 $BE$  is a diameter of the circle.  
 Angle  $DBE = 25^\circ$ .

- a) Find the size of angle  $ABD$ .  $65^\circ$   
 Give a reason for your answer.  
**Radius meets a tangent at  $90^\circ$**
- b) Find the size of angle  $DEB$ .  $65^\circ$   
 Give a reason for your answer.  
**Alternate segment theorem**

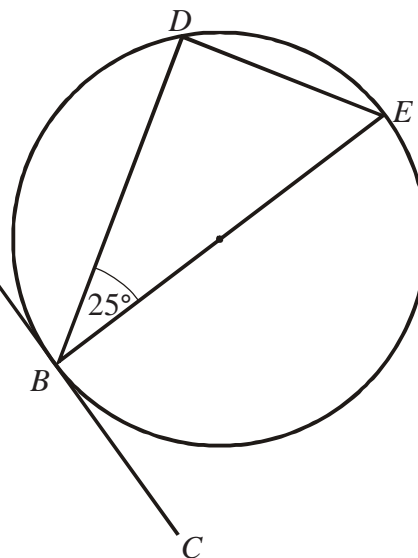

## Circle Theorems

- 1) In the diagram,  $A$ ,  $B$  and  $C$  are points on the circumference of a circle, centre  $O$ .  
 $PA$  and  $PB$  are tangents to the circle.  
 Angle  $ACB = 72^\circ$ .

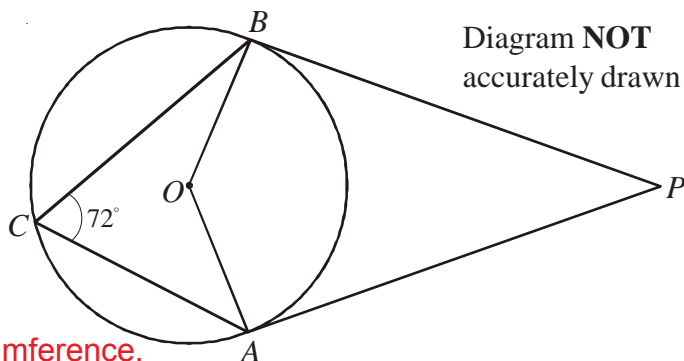

Diagram **NOT**  
accurately drawn

- a) (i) Work out the size of angle  $AOB$ .  **$144^\circ$**   
 (ii) Give a reason for your answer.  
**Angle at centre is twice angle on circumference.**
- b) Work out the size of angle  $APB$ .  **$36^\circ$**

- 2)  $P$ ,  $Q$ ,  $R$  and  $S$  are points on the circle.  
 $PQ$  is a diameter of the circle.  
 Angle  $RPQ = 32^\circ$ .

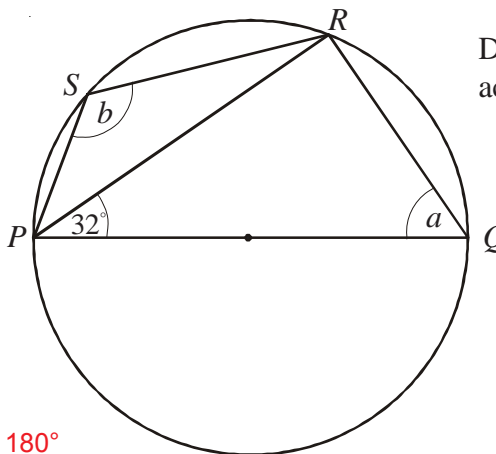

Diagram **NOT**  
accurately drawn

- a) (i) Work out the size of angle  $PQR$ .  **$58^\circ$**   
 (ii) Give reasons for your answer.  
**Angle in semi-circle is  $90^\circ$**   
**Angles in triangle add to  $180^\circ$**
- b) (i) Work out the size of angle  $PSR$ .  **$122^\circ$**   
 (ii) Give a reason for your answer.  
**Opposite angles of a cyclic quadrilateral add to  $180^\circ$**

- 3) The diagram shows a circle, centre  $O$ .  
 $AC$  is a diameter.  
 Angle  $BAC = 31^\circ$ .  
 $D$  is a point on  $AC$  such that angle  $BDA$  is a right angle.

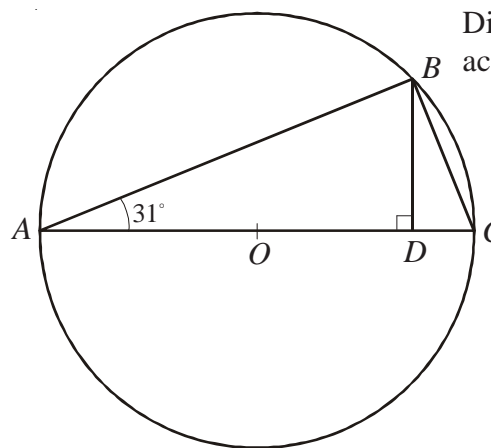

Diagram **NOT**  
accurately drawn

- a) Work out the size of angle  $BCA$ .  **$59^\circ$**   
 Give reasons for your answer.  
**Angle in semi-circle is  $90^\circ$**   
**Angles in triangle add to  $180^\circ$**
- b) Calculate the size of angle  $DBC$ .  **$31^\circ$**
- c) Calculate the size of angle  $BOA$ .  **$118^\circ$**

- 4)  $A$ ,  $B$ ,  $C$  and  $D$  are four points on the circumference of a circle.  
 $ABE$  and  $DCE$  are straight lines.  
 Angle  $BAC = 21^\circ$ . Angle  $EBC = 58^\circ$ .

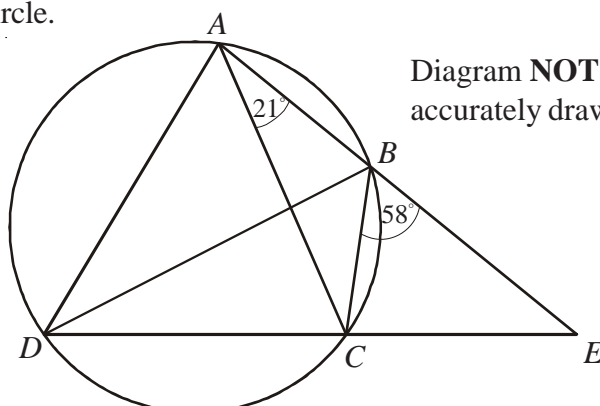

Diagram **NOT**  
accurately drawn

- a) Find the size of angle  $ADC$ .  **$58^\circ$**
- b) Find the size of angle  $ADB$ .  **$37^\circ$**
- Angle  $CAD = 69^\circ$ .
- c) Is  $BD$  a diameter of the circle? **Yes**  
 You must explain your answer.

**Angle  $DAB = 69^\circ + 21^\circ = 90^\circ$**   
 **$BD$  subtends  $90^\circ$  on the circumference. Therefore  $BD$  is a diameter.**



# Circle Theorems

1)  $a = \underline{44^\circ}$

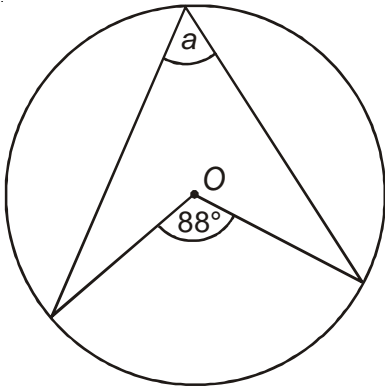

2)  $b = \underline{23^\circ}$

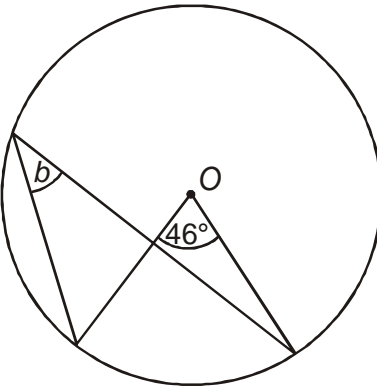

3)  $c = \underline{92^\circ}$

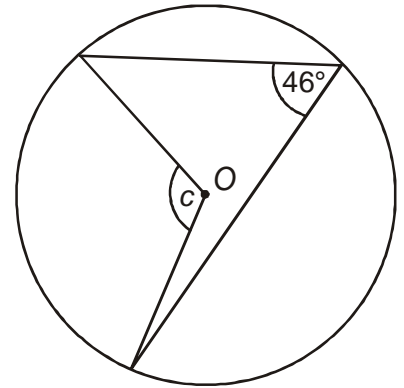

4)  $d = \underline{23^\circ}$

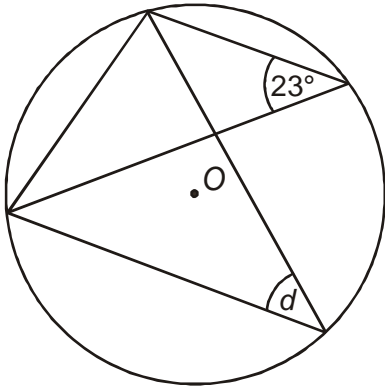

5)  $e = \underline{39^\circ}$   $f = \underline{56^\circ}$

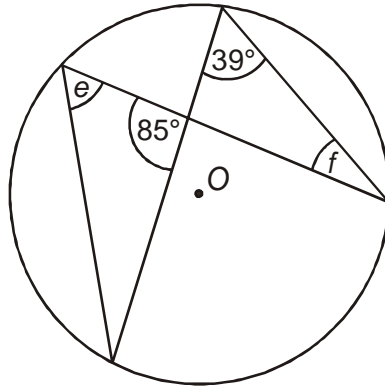

6)  $g = \underline{82^\circ}$

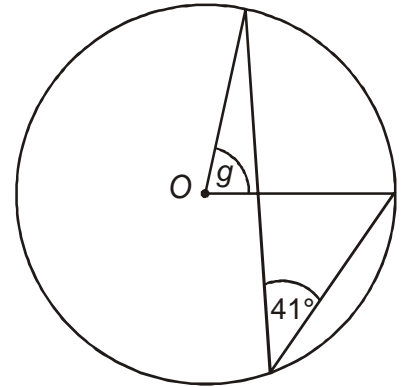

7)  $h = \underline{90^\circ}$

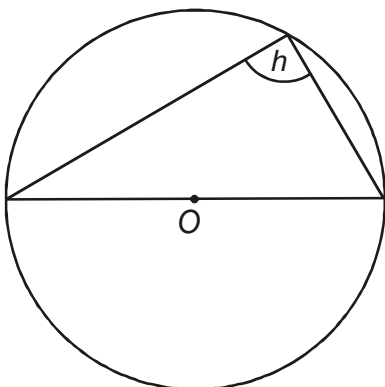

8)  $i = \underline{90^\circ}$

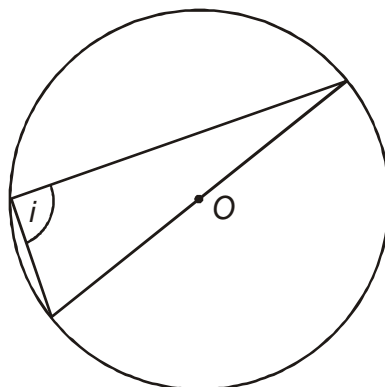

9)  $j = \underline{36^\circ}$   $k = \underline{54^\circ}$

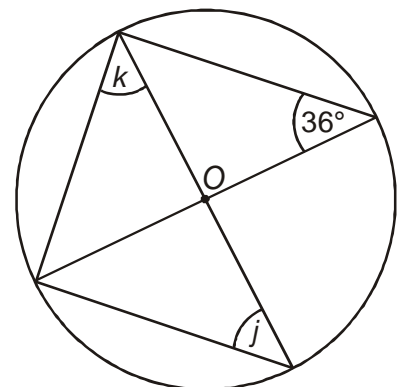

10)  $l = \underline{50^\circ}$   $m = \underline{40^\circ}$

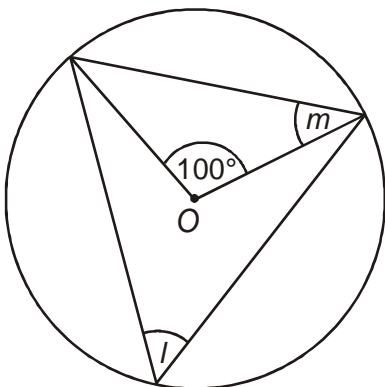

11)  $n = \underline{36^\circ}$   $p = \underline{72^\circ}$   $q = \underline{6^\circ}$

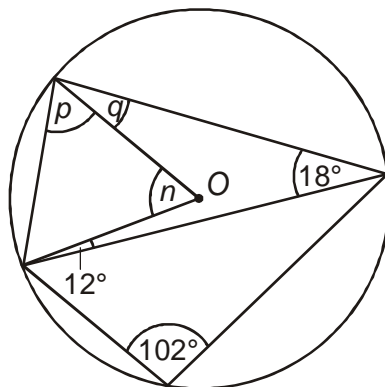

# Circle Theorems

1)  $a = 71^\circ$   $b = 92^\circ$

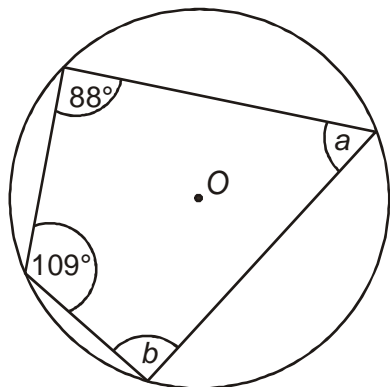

2)  $c = 60^\circ$   $d = 67^\circ$

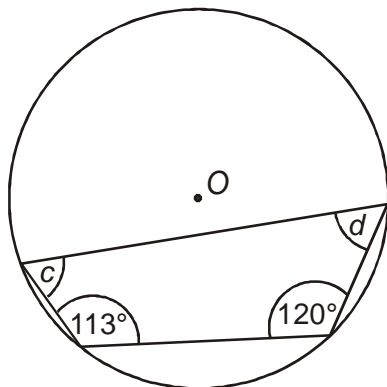

3)  $e = 98^\circ$   $f = 55^\circ$

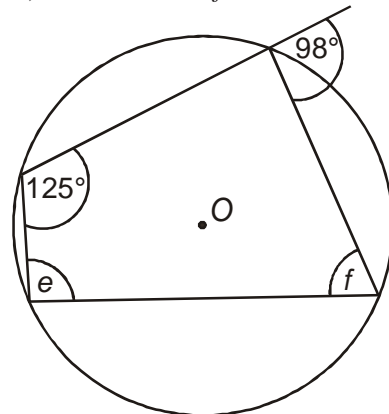

4)  $g = 100^\circ$   $h = 85^\circ$

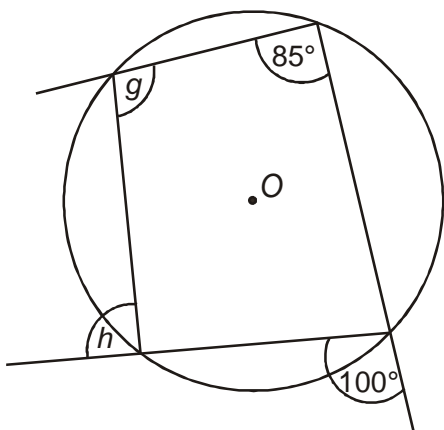

5)  $i = 39^\circ$

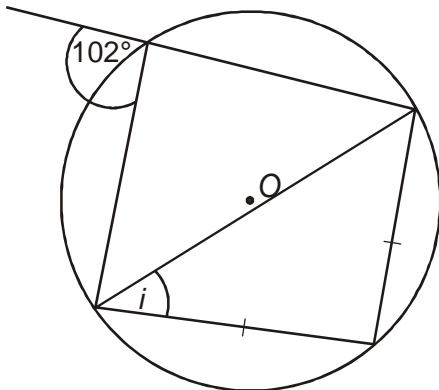

6)  $j = 136^\circ$

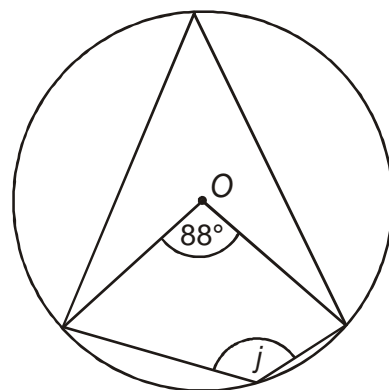

7)  $k = 56^\circ$   $l = 68^\circ$   $m = 45^\circ$

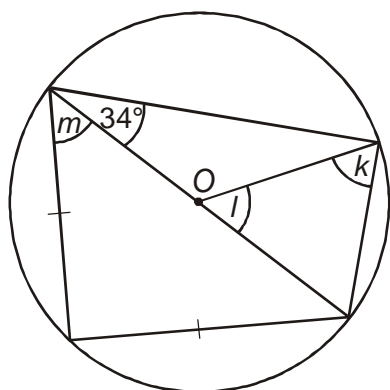

8)  $n = 19^\circ$   $p = 50^\circ$   $q = 50^\circ$

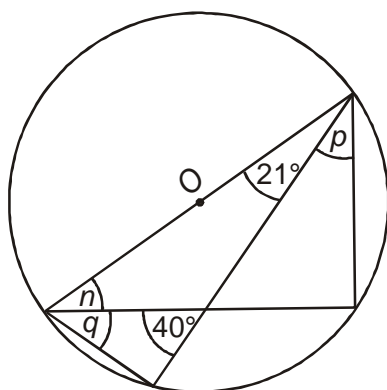

9)  $r = 23^\circ$   $s = 93^\circ$

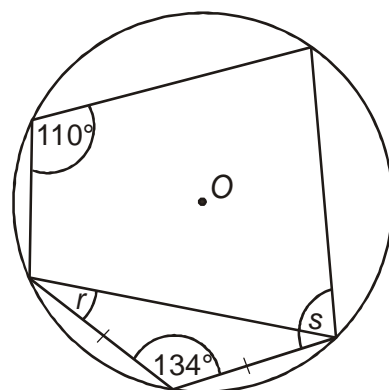

10)  $t = 42^\circ$

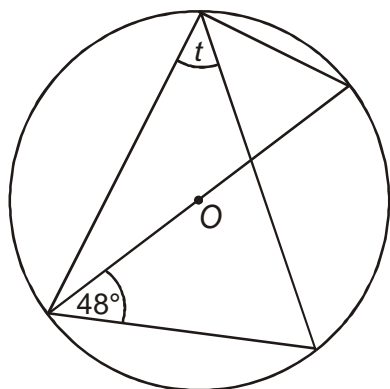

11)  $u = 5^\circ$

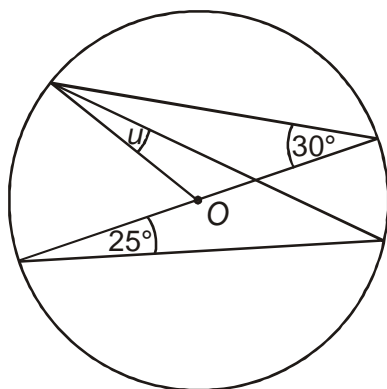

### Circle Theorems

1)  $a = 64^\circ$

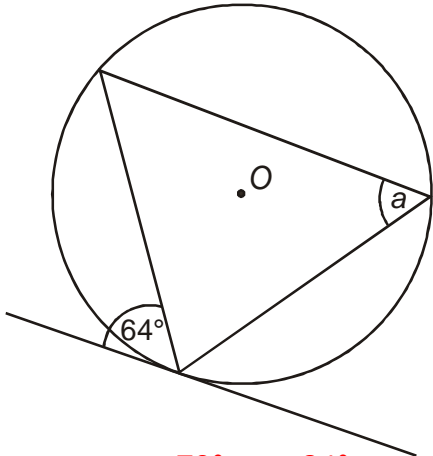

2)  $b = 51^\circ$   $c = 66^\circ$

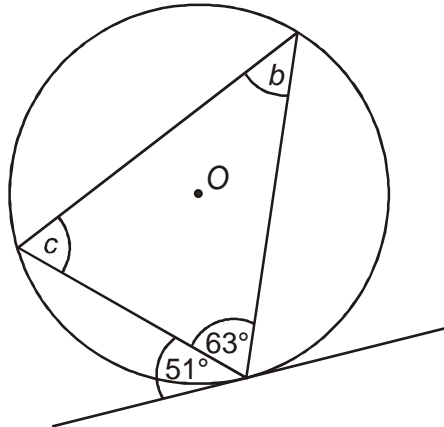

3)  $d = 92^\circ$   $e = 28^\circ$

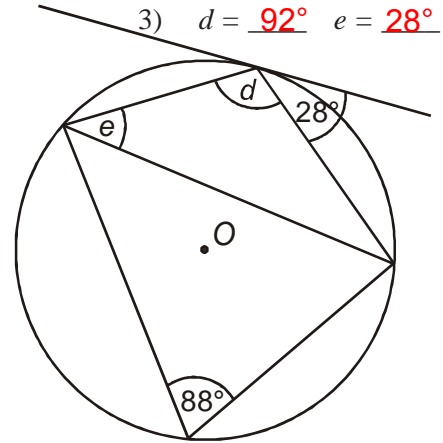

4)  $f = 78^\circ$   $g = 24^\circ$

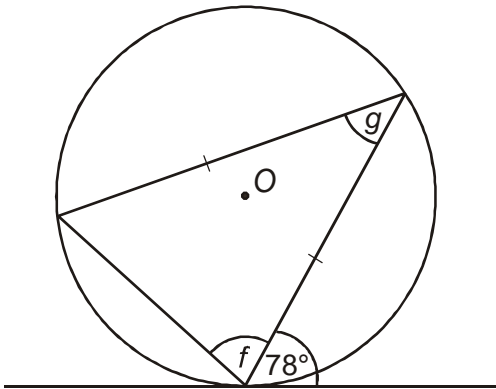

5)  $h = 50^\circ$   $i = 65^\circ$

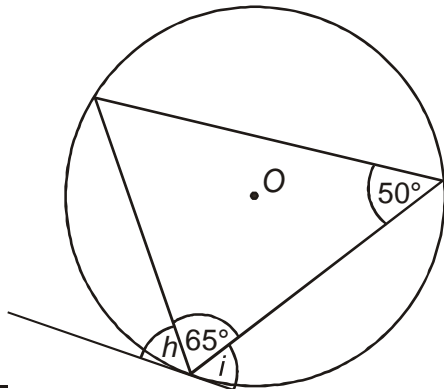

6)  $j = 100^\circ$   $k = 40^\circ$   $l = 40^\circ$   $m = 100^\circ$

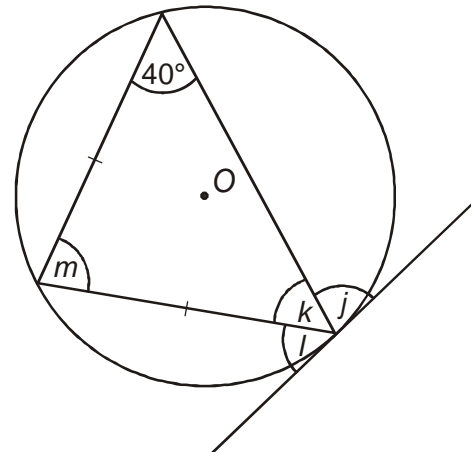

7)  $n = 81^\circ$

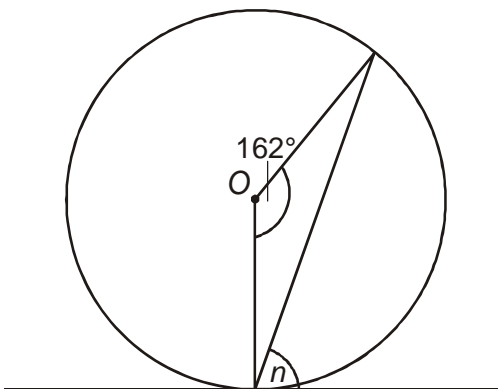

8)  $p = 52^\circ$   $q = 38^\circ$

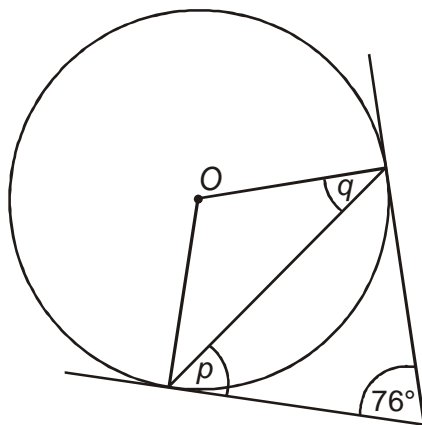

9)  $r = 50^\circ$   $s = 70^\circ$   $t = 20^\circ$

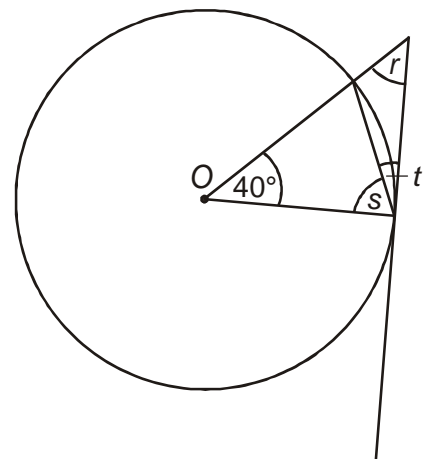

10)  $u = 18^\circ$   $v = 81^\circ$   $w = 18^\circ$

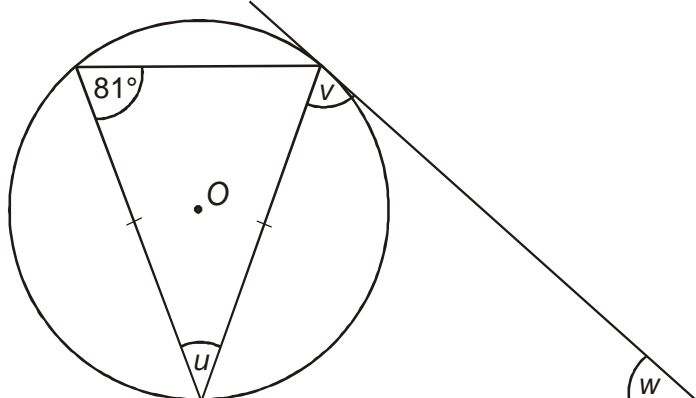

- 1) Prove that the angle subtended at the centre of a circle is twice the angle at the circumference.

Triangle  $AOC$  is isosceles ( $OC = OA$ , radii)

Angle  $OAC =$  angle  $OCA$  (base angles of triangle  $AOC$ )

Let angle  $OAC =$  angle  $OCA = x$

Angle  $COA = 180 - 2x$   
(angles in triangle =  $180^\circ$ )

Angle  $AOD = 2x$   
(angles on straight line =  $180^\circ$ )

Triangle  $BOC$  is isosceles ( $OC = OB$ , radii)

Angle  $OBC =$  angle  $OCB$  (base angles of triangle  $BOC$ )

Let angle  $OBC =$  angle  $OCB = y$

Angle  $COB = 180 - 2y$   
(angles in triangle =  $180^\circ$ )

Angle  $BOD = 2y$   
(angles on straight line =  $180^\circ$ )

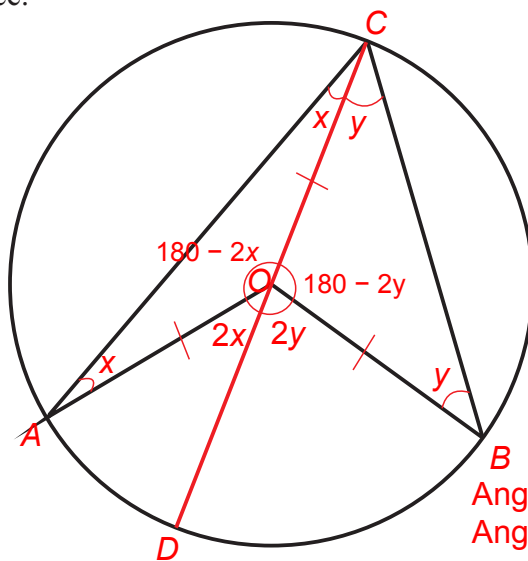

Angle  $AOB = 2x + 2y$   
Angle  $ACB = x + y$   
so angle  $AOB = 2 \times$  angle  $ACB$

- 2) Prove that angles in the same segment are equal.

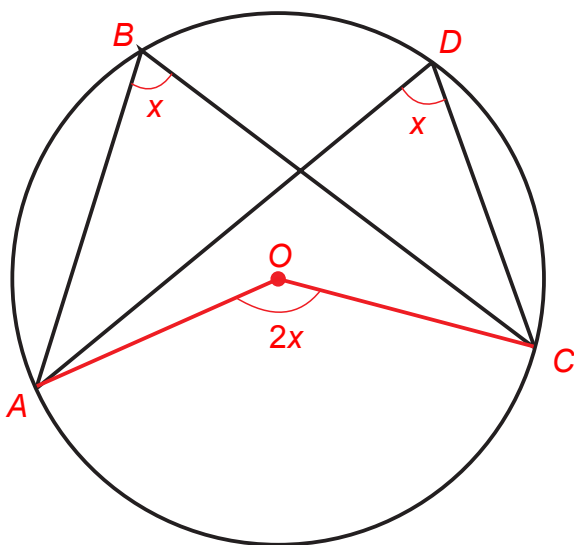

Let angle  $ABC = x$   
Angle  $AOC = 2x$  (angle at centre is twice angle at circumference)

Angle  $ADC = x$  (angle at circumference is half angle at centre)

Angle  $ABC =$  angle  $ADC = x$

- 3) Prove that opposite angles of a cyclic quadrilateral add up to  $180^\circ$ .

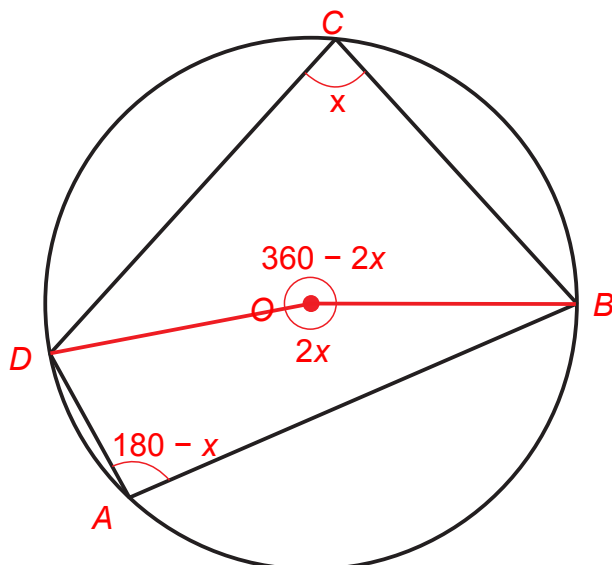

Let angle  $DCB = x$

Angle  $DOB = 2x$  (angle at centre is twice angle at circumference)

Reflex angle  $DOB = 360 - 2x$  (angles at point =  $360^\circ$ )

Angle  $DAB = 180 - x$  (angle at circumference is half angle at centre)

Angle  $DCB +$  angle  $DAB = x + 180 - x = 180^\circ$

- 1) In a class of 30 students, all of them have brothers or sisters or both.
- 19 have a brother.
- 16 have a sister.
- a) Complete the Venn diagram.

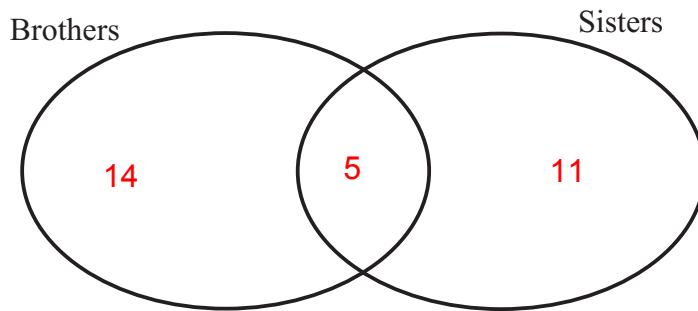

- b) Find the probability that a student in the class has a brother and a sister.  $\frac{5}{30}$
- c) If it is known that a student has a sister, what is the probability that they also have a brother?  $\frac{5}{16}$
- 2) A cafeteria serves only main courses and desserts. Some people just have a main, some have just a dessert and some have both.
- One day, 65% of the customers had a main course and 90% had a dessert.

- a) Show this information on a Venn diagram.

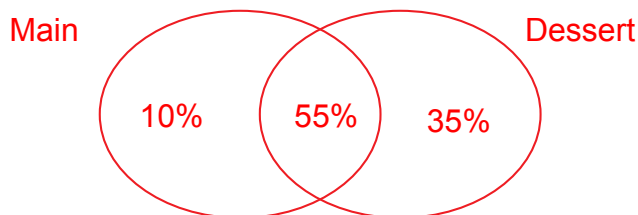

- b) What is the probability that a customer had a main course and a dessert?  $\frac{55}{100}$
- c) If it is known that a customer had a dessert, what is the probability that they also had a main course?  $\frac{55}{90}$

## Cumulative Frequency

The heights of 80 plants were measured and can be seen in the table, below.

Height ( $h$ cm)	Frequency
$0 < h < 10$	2
$10 < h < 20$	5
$20 < h < 30$	19
$30 < h < 40$	38
$40 < h < 50$	13
$50 < h < 60$	3

a) Complete the cumulative frequency table for the plants.

Height ( $h$ cm)	Cumulative Frequency
$0 < h < 10$	2
$0 < h < 20$	7
$0 < h < 30$	26
$0 < h < 40$	64
$0 < h < 50$	77
$0 < h < 60$	80

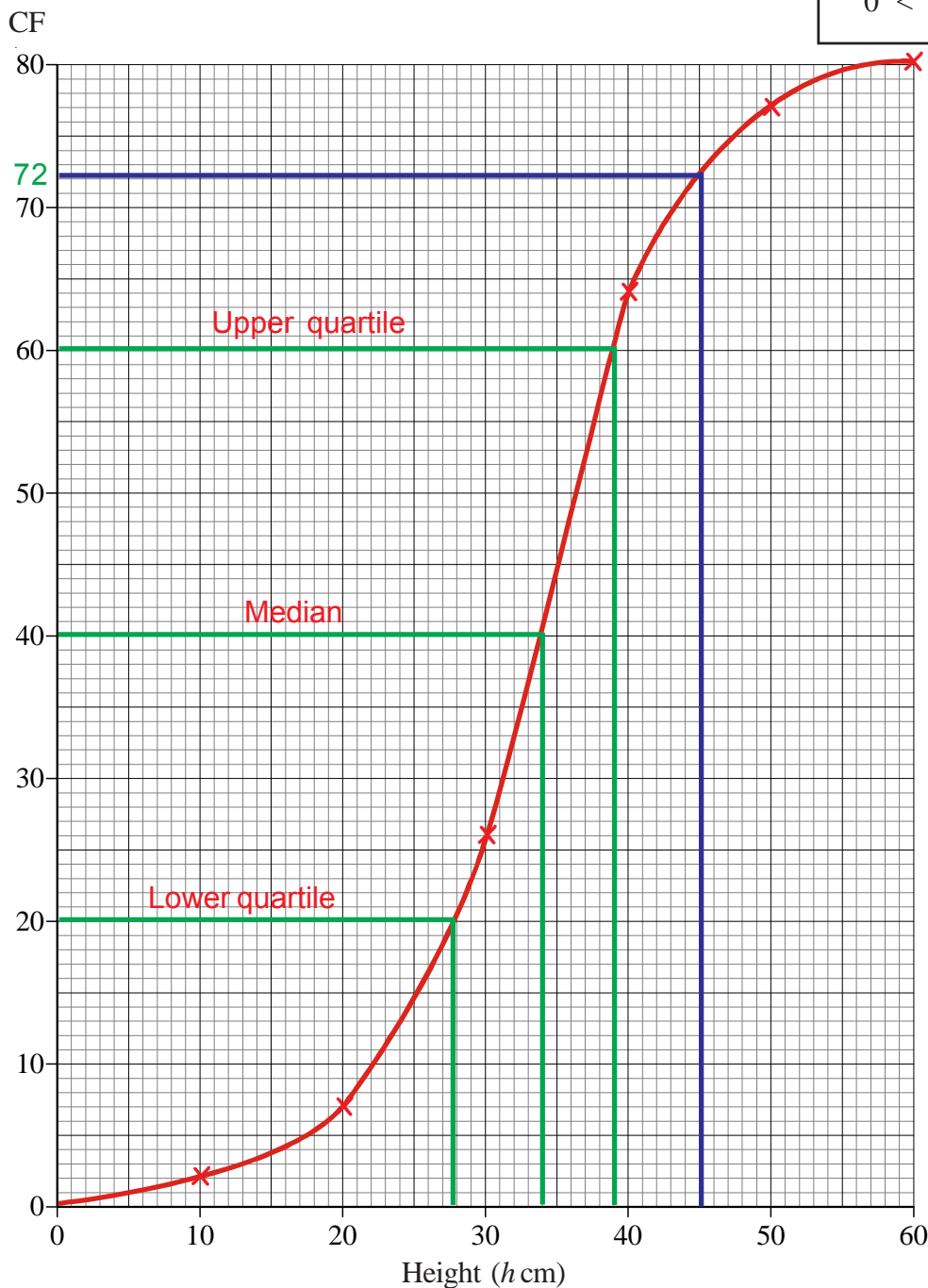

b) Draw a cumulative frequency graph for your table.

c) Use your graph to find an estimate for

(i) the median height of a plant.

34 cm

(ii) the interquartile range of the heights of the plants.

$$39 - 27.7 = 11.3 \text{ cm}$$

d) Use your graph to estimate how many plants had a height that was greater than 45cm.

$$80 - 72 = 8 \text{ plants}$$

## Cumulative Frequency

The table shows information about the amount spent by 100 customers in a supermarket.

Amount spent (£ $n$ )	Frequency
$0 < n < 20$	17
$20 < n < 40$	23
$40 < n < 60$	36
$60 < n < 80$	14
$80 < n < 100$	8
$100 < n < 120$	2

a) Complete the cumulative frequency table for this information.

Amount spent (£ $n$ )	Cumulative frequency
$0 < n < 20$	17
$0 < n < 40$	40
$0 < n < 60$	76
$0 < n < 80$	90
$0 < n < 100$	98
$0 < n < 120$	100

b) On the grid, draw a cumulative frequency graph for your table.

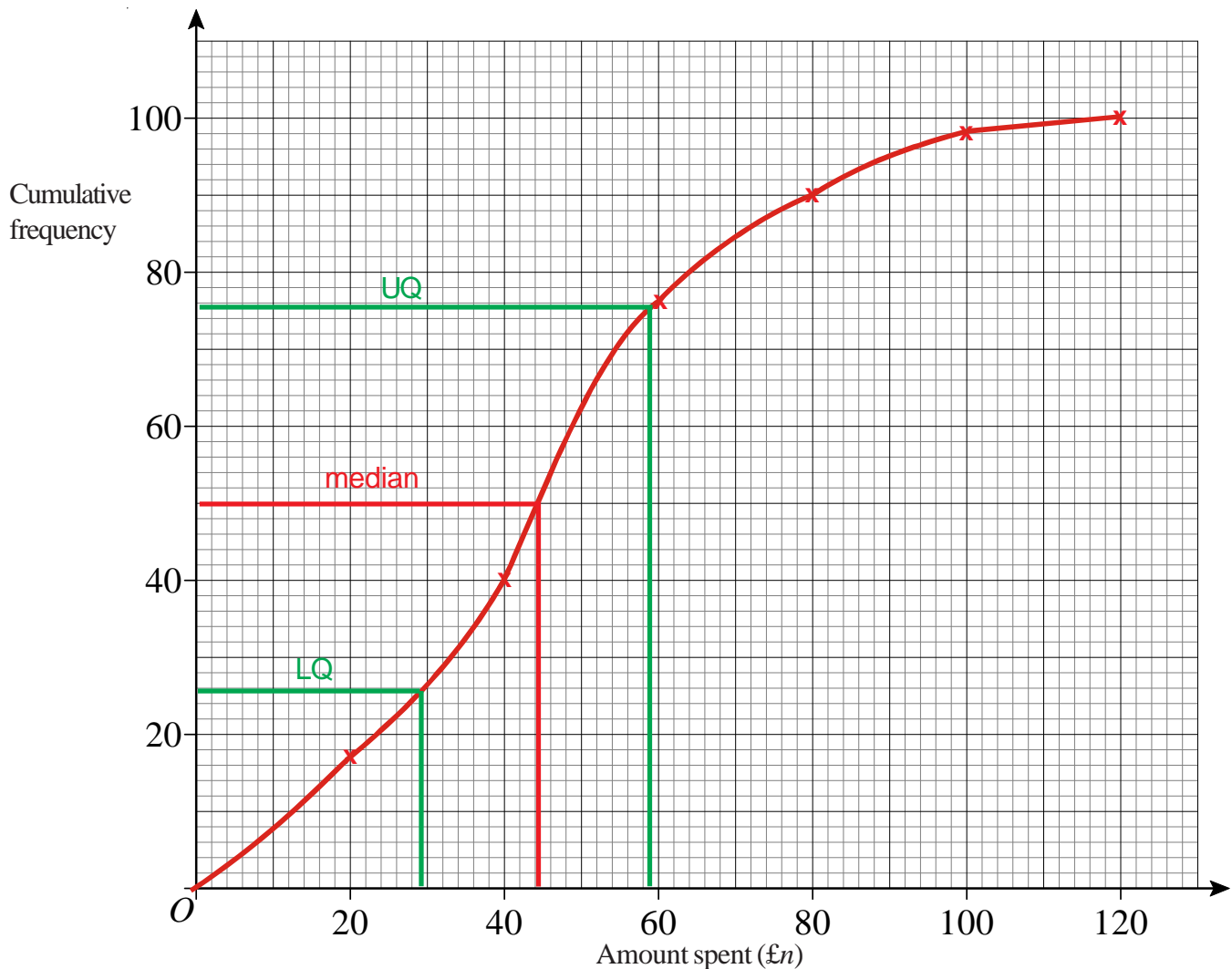

c) Use your graph to find an estimate for the median amount spent. **£44**

d) Use your graph to find an estimate for the interquartile range of the amount of money spent. **£59 – £29 = £30**

# Cumulative Frequency

Fred did a survey about the amount of money spent by 120 men at Christmas. The cumulative frequency table gives some information about the amounts of money spent by the 120 men.

Amount (£A) spent	Cumulative frequency
$0 < A < 100$	12
$0 < A < 150$	26
$0 < A < 200$	42
$0 < A < 250$	64
$0 < A < 300$	93
$0 < A < 350$	112
$0 < A < 400$	120

a) On the grid, draw a cumulative frequency diagram.

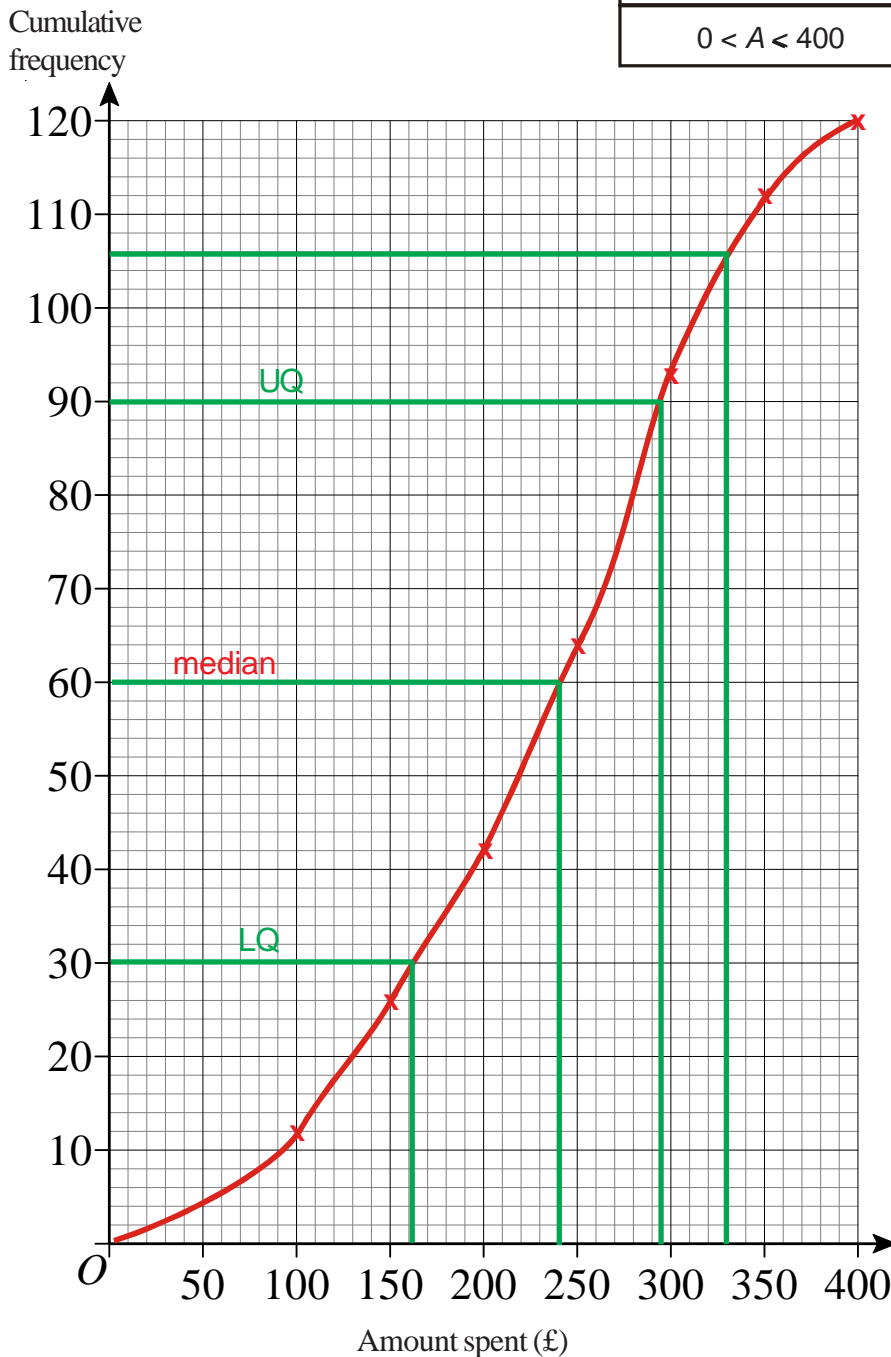

- b) Use your cumulative frequency diagram to estimate the median. £240
- c) Use your cumulative frequency diagram to estimate the interquartile range of the amount of money spent. £295 – £160 = £135
- d) Use your cumulative frequency diagram to estimate the number of men who spent more than £330. 14



## Cumulative Frequency

The table gives some information about the delay, in minutes, of 80 trains.

a) Complete the cumulative frequency table.

Delay ( $n$ minutes)	Frequency
$0 < n < 20$	16
$20 < n < 30$	27
$30 < n < 40$	22
$40 < n < 50$	10
$50 < n < 60$	5

Delay ( $n$ minutes)	Cumulative Frequency
$0 < n < 20$	16
$0 < n < 30$	43
$0 < n < 40$	65
$0 < n < 50$	75
$0 < n < 60$	80

b) On the grid below, draw a cumulative frequency graph for your table.

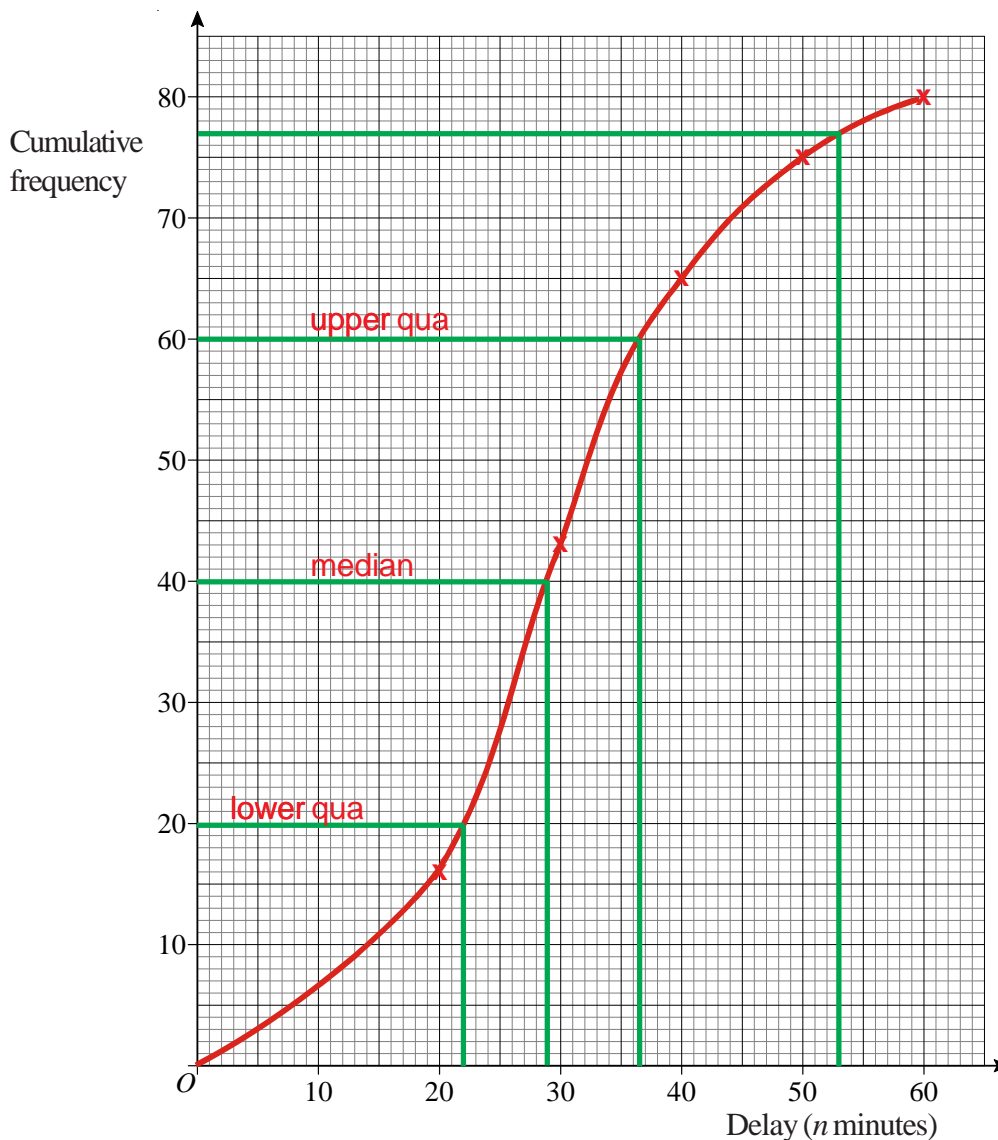

c) Use your graph to find an estimate for

- the median delay. **29 minutes**
- the interquartile range of the delays.  **$36.5 - 22 = 14.5$  minutes**
- the number of trains delayed for more than 53 minutes. **3**

## Cumulative Frequency

There are 100 teachers at Sam's school.  
Sam found out the age of each teacher.

The table gives information about her results. a) Complete the cumulative frequency table

Age ( $A$ years)	Frequency
$20 < A < 30$	25
$30 < A < 40$	36
$40 < A < 50$	22
$50 < A < 60$	11
$60 < A < 70$	6

Age ( $A$ years)	Cumulative Frequency
$20 < A < 30$	25
$20 < A < 40$	61
$20 < A < 50$	83
$20 < A < 60$	94
$20 < A < 70$	100

b) On the grid, draw a cumulative frequency graph for your table.

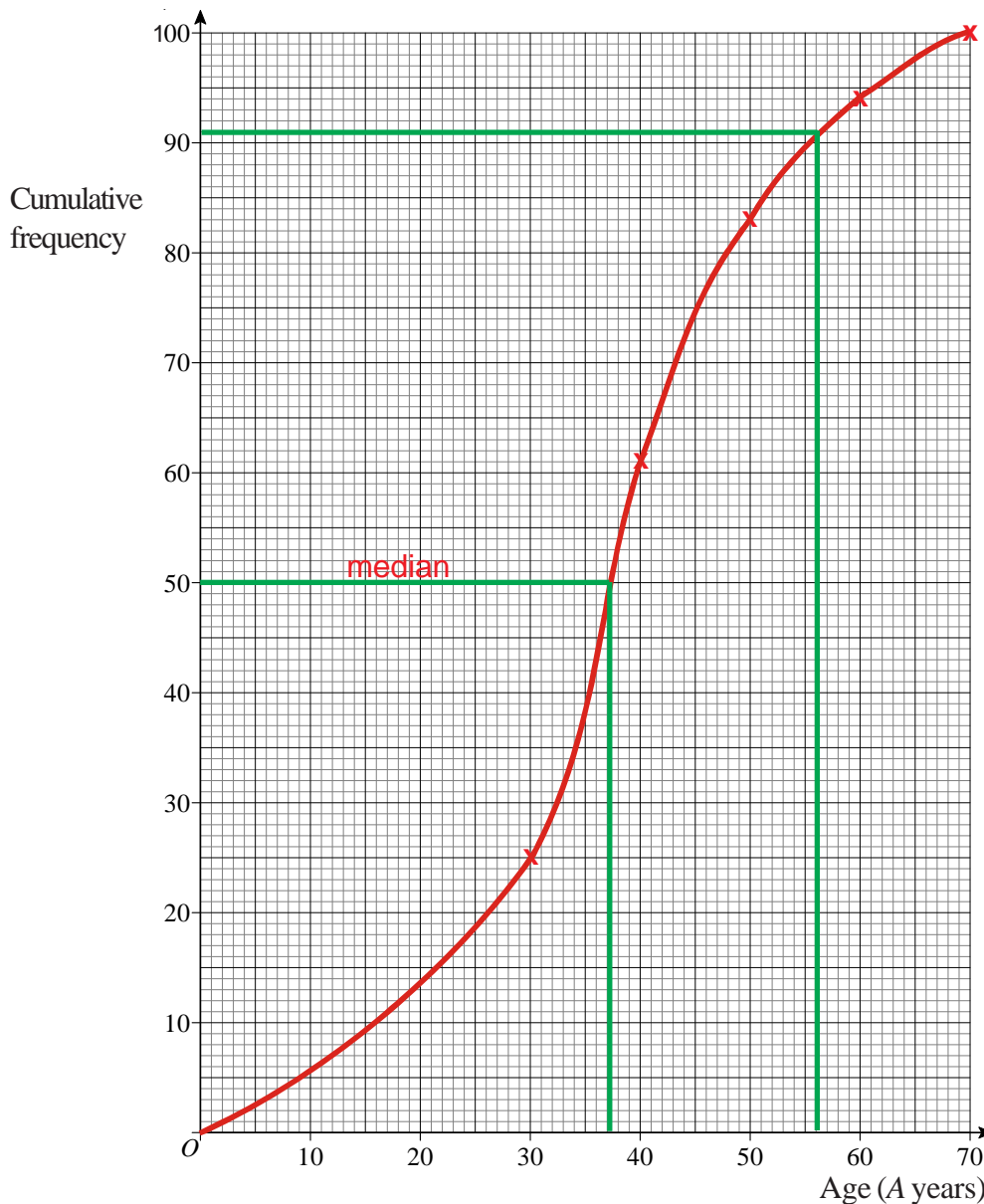

- c) Use your graph to find an estimate for the median age. **37 years**  
d) Use your graph to find an estimate for the number of these teachers who are **older** than 56 years old. **9**

## Cumulative Frequency

This table shows information about the time,  $m$  minutes, it takes to show each of 120 films.

Time ( $m$ minutes)	Frequency
$70 < m \leq 80$	3
$80 < m \leq 90$	13
$90 < m \leq 100$	34
$100 < m \leq 110$	32
$110 < m \leq 120$	26
$120 < m \leq 130$	12

- a) Write down the modal class interval.  $90 < m < 100$   
 b) Complete this cumulative frequency table.

Time ( $m$ minutes)	Cumulative frequency
$70 < m \leq 80$	3
$70 < m \leq 90$	16
$70 < m \leq 100$	50
$70 < m \leq 110$	82
$70 < m \leq 120$	108
$70 < m \leq 130$	120

- c) On the grid, draw a cumulative frequency graph for your cumulative frequency table.

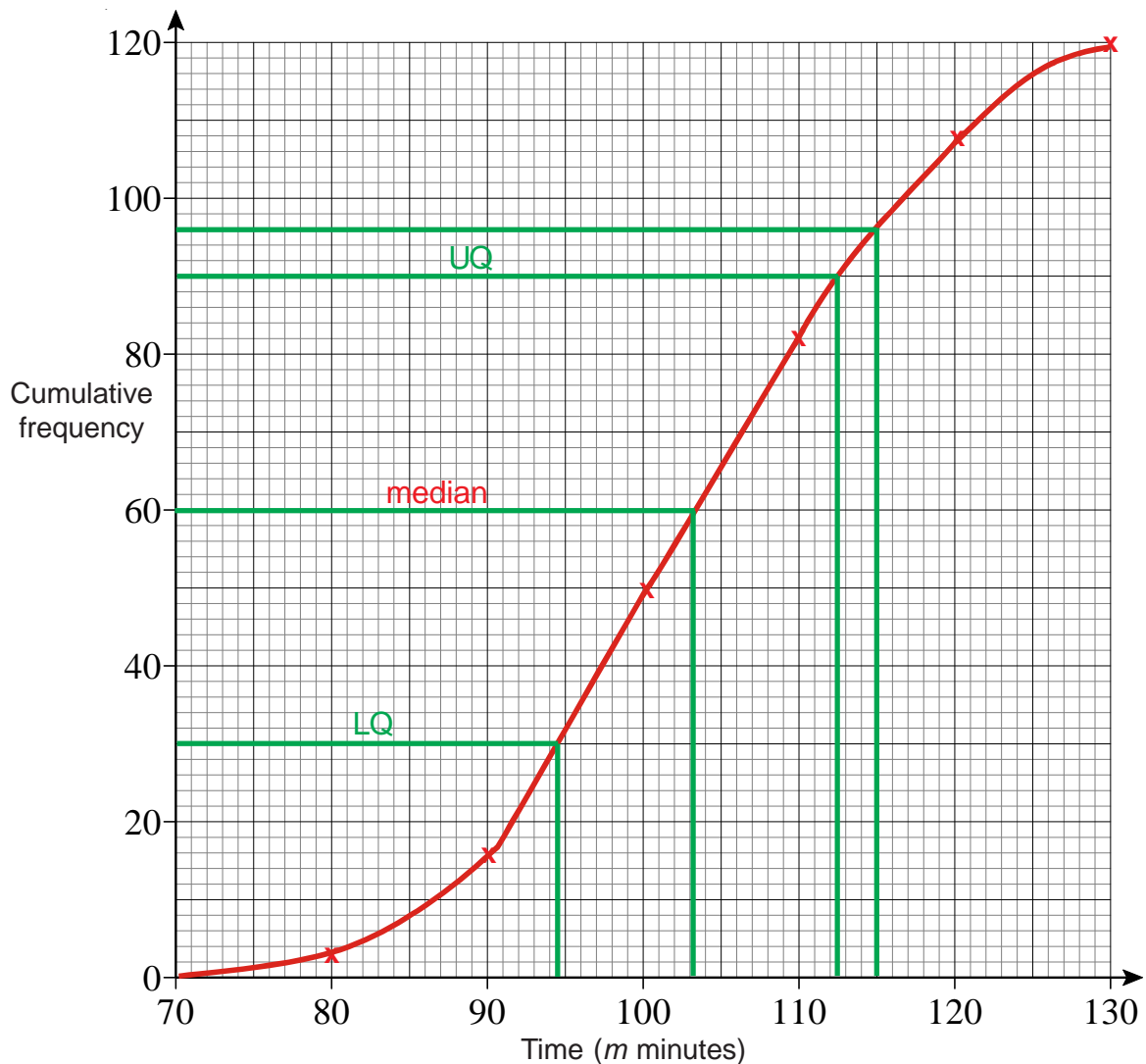

- d) Use your graph to find an estimate for the median. **103 minutes**  
 e) Use your graph to find an estimate for the interquartile range of times.  $112.5 - 94.5 = 18$  minutes  
 f) Use your graph to find an estimate for the number of films which take longer than 115 minutes to show. **24 films** Page 186 F

# Boxplots

1) The ages of 20 teachers are listed below.



a) On the grid below, draw a box plot to show the information about the teachers.

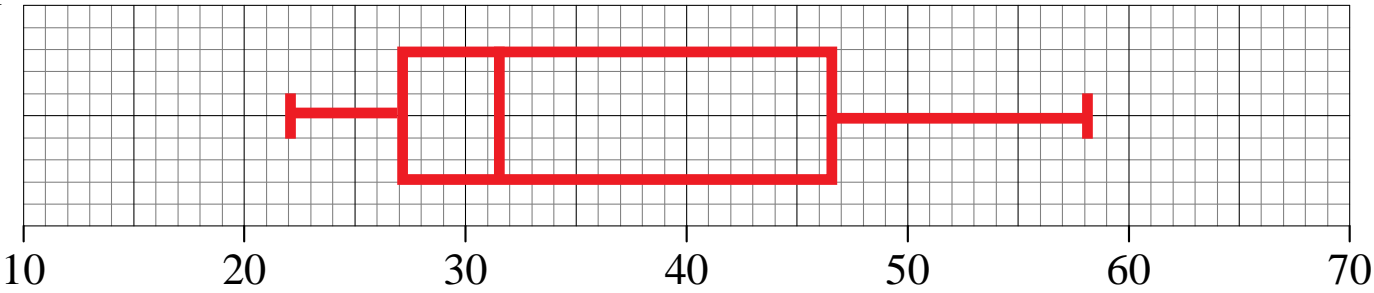

b) What is the interquartile range of the ages of the teachers? 19.5 years

2) A warehouse has 60 employees working in it.

The age of the youngest employee is 16 years.  
The age of the oldest employee is 55 years.

The median age is 37 years.  
The lower quartile age is 29 years.  
The upper quartile age is 43 years.

On the grid below, draw a box plot to show information about the ages of the employees.

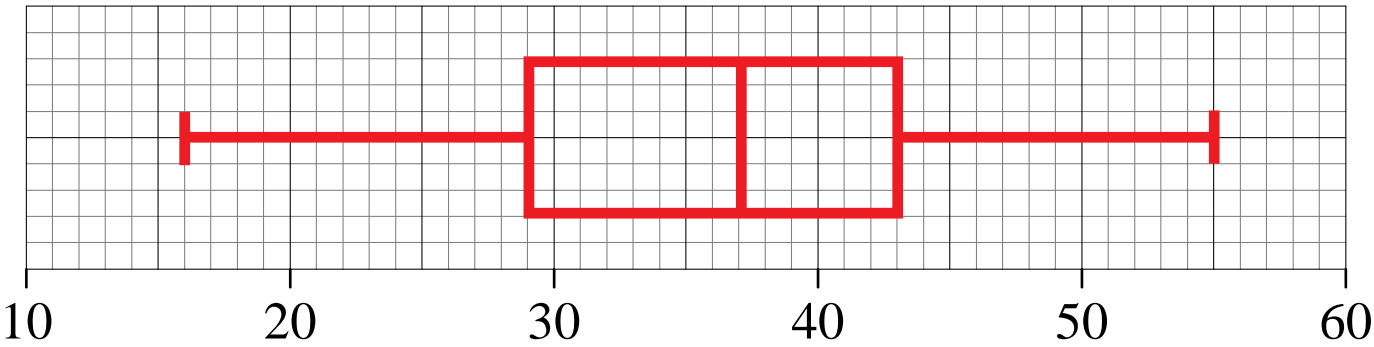

# Boxplots

Terry drew a line of length 60 cm.  
He asked some children to estimate the length of the line he had drawn.  
He recorded their estimates.  
The box plot gives some information about these estimates.

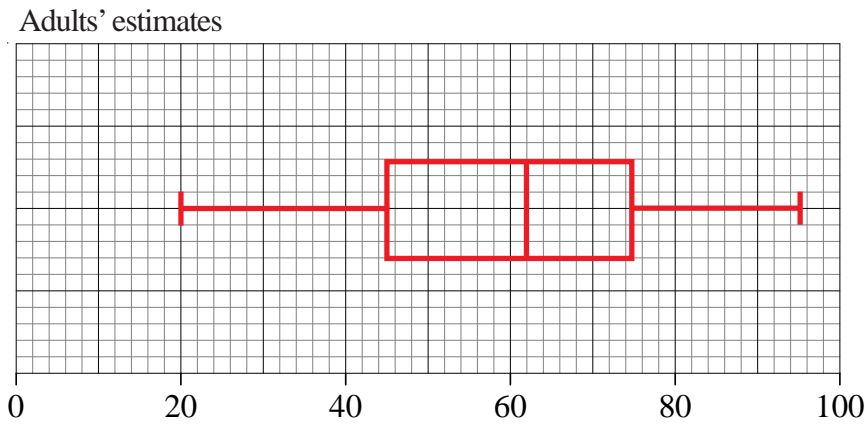
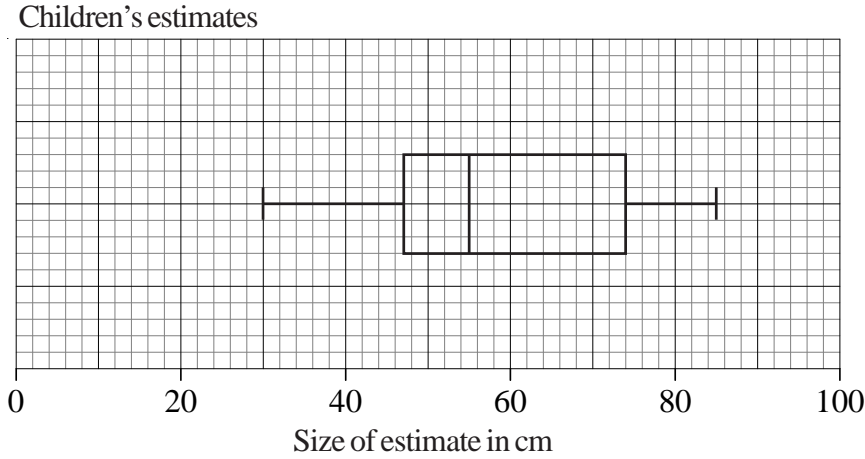

- a) Write down the median of the children's estimates. **55 cm**
- b) Write down the interquartile range of the children's estimates.  **$74 - 47 = 27$  cm**

Terry then asked some adults to estimate the length of the line he had drawn.  
The table gives some information about the adults' estimates.

	Length
Lowest estimate	20 cm
Lower quartile	45 cm
Median	62 cm
Upper quartile	75 cm
Highest estimate	95 cm

- c) On the grid above, draw a box plot to show this information.
- d) Use the two box plots to compare the distribution of the children's estimates with the distribution of the adults' estimates.

**The median estimate is bigger for adults  
or The interquartile range is bigger for adults  
or The range is bigger for adults**

## Boxplots

- 1) The box plot gives information about the distribution of the weights of bags on a plane.

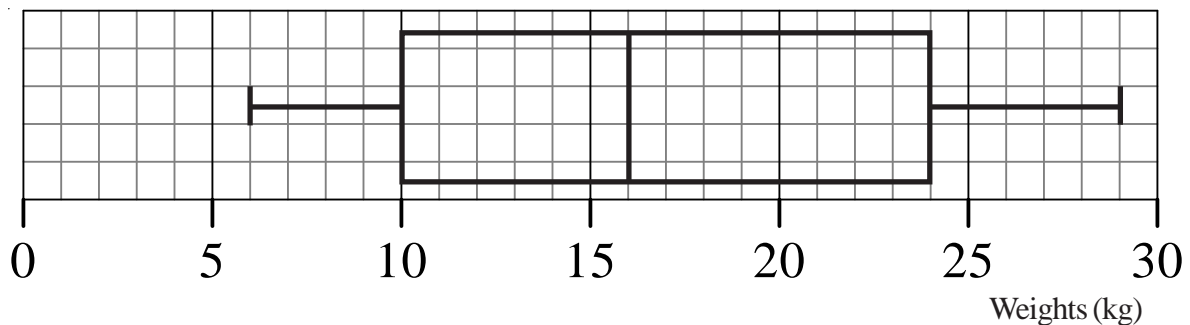

- a) Claude says that the heaviest bag weighs 24 kg.  
He is **wrong**.  
Explain why.

**The heaviest bag is 29 kg**

- b) Write down the median weight. **16 kg**
- c) Work out the interquartile range of the weights.  **$24 - 10 = 14$  kg**

There are 240 bags on the plane.

- d) Work out the number of bags with a weight of 10 kg or less. **60 bags**  
**10 kg is the lower quartile which means a quarter of 240 bags are 10 kg or less. A quarter of 240 is 60.**

- 2) The box plots show the distribution of marks in a Science and Maths test for a group of students.

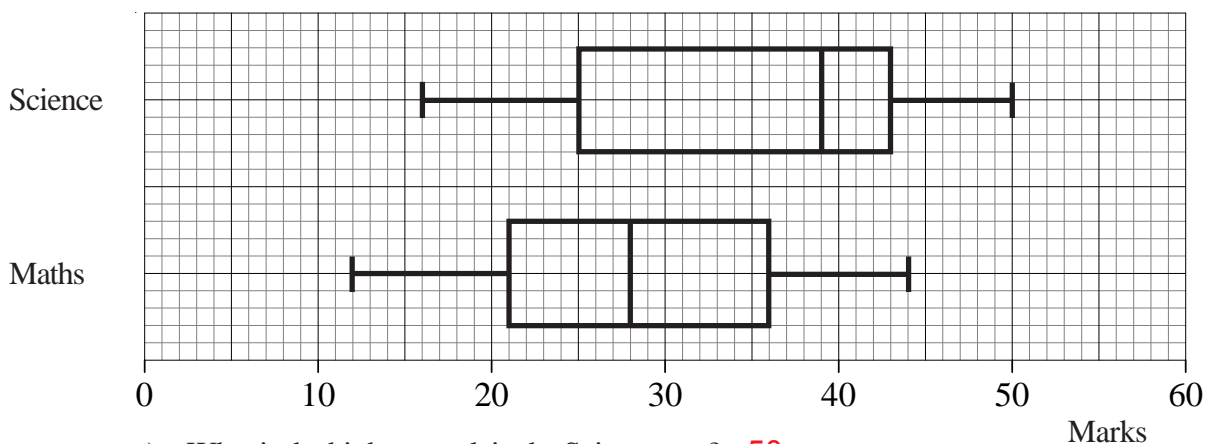

- a) What is the highest mark in the Science test? **50**
- b) Compare the distribution of the marks in the Science test and marks in the Maths test.
- 1 **The interquartile range for Science is bigger than for Maths.**
  - 2 **The median Science mark is bigger than the median Maths mark.**

## Boxplots

1) The incomplete box plot and table show some information about some marks.

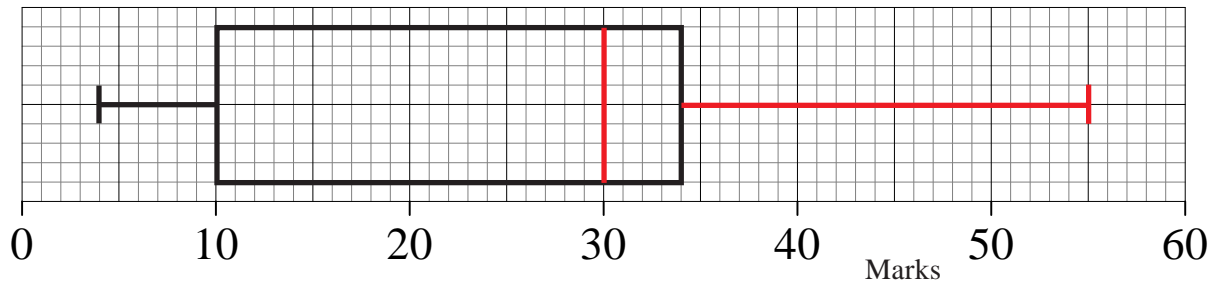

	Marks
Lowest mark	4
Lower quartile	10
Median	30
Upper quartile	34
Highest mark	55

- Use the information in the table to complete the box plot.
- Use the information in the box plot to complete the table.

2) Kim measured the height, in cm, of each tomato plant in her greenhouse. She used the results to draw the box plot shown below.

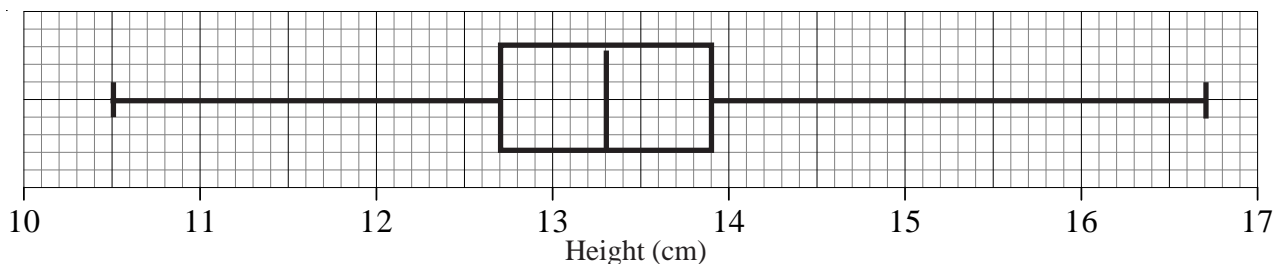

- Write down the median height. **13.3 cm**
- Work out the interquartile range.  **$13.9 - 12.7 = 1.2$  cm**
- Explain why the interquartile range may be a better measure of spread than the range. **It avoids the outlandishly tall and short plants.**

1) Simplify the following:

a)  $y^4 \times y^5$       $y^9$

b)  $x^2 \times x^6$       $x^8$

c)  $(p^4)^5$       $p^{20}$

d)  $(x^3)^2$       $x^6$

e)  $(x^4)^{-2}$       $x^{-8}$

f)  $(x^{-3})^{-5}$       $x^{15}$

g)  $x^7 \div x^2$       $x^5$

h)  $\frac{t^5}{t^3}$       $t^2$

2) Work out the value of the following, leaving your answer in fraction form when necessary

a)  $5^0$       $1$

b)  $4^{-2}$       $\frac{1}{16}$

c)  $5^{-3}$       $\frac{1}{125}$

d)  $49^{\frac{1}{2}}$       $7$

e)  $8^{\frac{1}{3}}$       $2$

f)  $32^{\frac{2}{5}}$       $4$

g)  $16^{-\frac{1}{2}}$       $\frac{1}{4}$

h)  $27^{-\frac{1}{3}}$       $\frac{1}{3}$

i)  $64^{-\frac{2}{3}}$       $\frac{1}{16}$

3)  $5\sqrt{5}$  can be written in the form  $5^n$ .

Calculate the value of  $n$ .      $1\frac{1}{2}$

4)  $2\sqrt[3]{8}$  can be written in the form  $2^n$ .

Calculate the value of  $n$ .      $2\frac{1}{2}$

5)  $a = 2^x$ ,  $b = 2^y$

Express in terms of  $a$  and  $b$

(i)  $2^{x+y}$       $ab$

(ii)  $2^{2x}$       $a^2$

(iii)  $2^{x+2y}$       $ab^2$



- 1) a) Convert the recurring decimal  $0.\dot{3}\dot{6}$  to a fraction in its simplest form.  $\frac{4}{11}$
- b) Prove that the recurring decimal  $0.\dot{7}\dot{2} = \frac{8}{11}$   $0.\dot{7}\dot{2} = 2 \times 0.\dot{3}\dot{6}$   
 $0.\dot{7}\dot{2} = 2 \times \frac{4}{11}$   
 $0.\dot{7}\dot{2} = \frac{8}{11}$
- 2) a) Change  $\frac{4}{9}$  to a decimal.  $0.\dot{4}$
- b) Prove that the recurring decimal  $0.\dot{5}\dot{7} = \frac{19}{33}$   $x = 0.5757\dots$   
 $100x = 57.5757\dots$   
 $99x = 57$   
 $x = \frac{57}{99} = \frac{19}{33}$
- 3) a) Change  $\frac{3}{11}$  to a decimal.  $0.\dot{2}\dot{7}$
- b) Prove that the recurring decimal  $0.\dot{4}\dot{5} = \frac{15}{33}$   $x = 0.4545\dots$   
 $100x = 45.4545\dots$   
 $99x = 45$   
 $x = \frac{45}{99} = \frac{15}{33}$
- 4) a) Change  $\frac{1}{6}$  to a decimal.  $0.\dot{1}\dot{6}$
- b) Prove that the recurring decimal  $0.\dot{1}\dot{3}\dot{5} = \frac{5}{37}$   $x = 0.135135\dots$   
 $1000x = 135.135135\dots$   
 $999x = 135$   
 $x = \frac{135}{999} = \frac{5}{37}$
- 5) a) Convert the recurring decimal  $0.\dot{2}\dot{6}\dot{1}$  to a fraction in its simplest form.  $\frac{29}{111}$
- b) Prove that the recurring decimal  $0.2\dot{7} = \frac{5}{18}$   $x = 0.2777\dots$   
 $100x = 27.777\dots$   
 $99x = 27.5$   
 $x = \frac{27.5}{99} = \frac{55}{198} = \frac{5}{18}$
- 6) a) Convert the recurring decimal  $5.\dot{2}$  to a fraction in its simplest form.  $x = 5.222\dots$   
 $10x = 52.222\dots$
- b) Prove that the recurring decimal  $0.1\dot{3}\dot{6} = \frac{3}{22}$   $9x = 47$   
 $x = \frac{47}{9} = 5\frac{2}{9}$   
 $x = 0.13636\dots$   
 $100x = 13.63636\dots$   
 $99x = 13.5$   
 $x = \frac{13.5}{99} = \frac{27}{198} = \frac{3}{22}$

- 1) Make  $c$  the subject of the formula.

$$v = 2a + 3b + c \quad c = v - 2a - 3b$$

- 2) Make  $t$  the subject of the formula.

$$A = \pi t + 5t \quad t = \frac{A}{\pi + 5}$$

- 3) Make  $s$  the subject of the formula.

$$R = 3s + \pi s + 2t \quad s = \frac{R - 2t}{3 + \pi}$$

4)  $k = \frac{l}{m - l}$

- a) Make  $l$  the subject of the formula.  $l = \frac{km}{1 + k}$

- b) Make  $m$  the subject of the formula.

$$m = \frac{l + kl}{k}$$

5)  $A = \frac{k(x + 5)}{3}$

- Make  $x$  the subject of the formula.  $x = \frac{3A - 5k}{k}$

6)  $R = \frac{u + v^2}{u + v}$

- Make  $u$  the subject of the formula.  $u = \frac{v^2 - Rv}{R - 1}$

7)  $\frac{3x + 2}{5} = \frac{y}{10 + y}$

- Make  $y$  the subject of the formula.  $y = \frac{30x + 20}{3 - 3x}$

8)  $\sqrt{\frac{a - 3}{5}} = 4b$

- Rearrange this formula to give  $a$  in terms of  $b$ .  $a = 80b^2 + 3$

9)  $S = 2\pi d\sqrt{h^2 + d^2}$

- Rearrange this formula to make  $h$  the subject.  $h = \sqrt{\frac{S^2}{4\pi^2 d^2} - d^2}$

## Solving Quadratics with the Formula



- 1) Solve the equation  $x^2 + 4x + 1 = 0$   
Give your answers correct to 3 decimal places.

$$x = -0.268 \text{ or } x = -3.732$$



- 2) Solve the equation  $x^2 + 8x + 6 = 0$   
Give your answers correct to 3 significant figures.

$$x = -0.838 \text{ or } x = -7.16$$



- 3) Solve the equation  $x^2 - 3x - 2 = 0$   
Give your answers correct to 3 significant figures.

$$x = -0.562 \text{ or } x = 3.56$$



- 4) Solve the equation  $x^2 - 7x + 2 = 0$   
Give your answers correct to 3 significant figures.

$$x = 0.298 \text{ or } x = 6.70$$



- 5) Solve the equation  $2x^2 + 6x - 1 = 0$   
Give your answers correct to 3 significant figures.

$$x = -3.16 \text{ or } x = 0.158$$



- 6) Solve the equation  $3x^2 - 2x - 20 = 0$   
Give your answers correct to 3 significant figures.

$$x = -2.27 \text{ or } x = 2.94$$



- 7) Solve the equation  $x^2 - 14x - 161.25 = 0$

$$x = -7.5 \text{ or } x = 21.5$$



- 8) Solve the equation  $17x^2 - 92x - 206 = 0$   
Give your answers correct to 3 significant figures.

$$x = -1.70 \text{ or } x = 7.11$$



- 9)  $x^2 + 10x = 300$   
Find the positive value of  $x$ .  
Give your answer correct to 3 significant figures.

$$x = 13.0$$



- 10)  $(x + 2)(x - 3) = 1$   $x^2 - 3x + 2x - 6 = 1$   
 $x^2 - x - 6 = 1$   
 a) Show that  $x^2 - x - 7 = 0$   $x^2 - x - 7 = 0$   
 b) Solve the equation  $x^2 - x - 7 = 0$

Give your answers correct to 3 significant figures.

$$x = -2.19 \text{ or } x = 3.19$$

1) Factorise the following:

a)  $2x^2 + 7x + 3$      $(2x + 1)(x + 3)$

b)  $3x^2 + 5x - 2$      $(x + 2)(3x - 1)$

c)  $6x^2 - 11x + 3$      $(2x - 3)(3x - 1)$

d)  $8x^2 + 10x + 3$      $(2x + 1)(4x + 3)$

e)  $6x^2 - 7x - 20$      $(2x - 5)(3x + 4)$

f)  $4x^2 - 4x - 15$      $(2x - 5)(2x + 3)$

2) Solve the following:

a)  $5x^2 + 9x - 2 = 0$      $x = -2, x = \frac{1}{5}$

b)  $6x^2 + 5x - 6 = 0$      $x = -\frac{3}{2}, x = \frac{2}{3}$

c)  $12x^2 + 25x + 7 = 0$      $x = -\frac{1}{3}, x = -\frac{7}{4}$

d)  $8x^2 - 14x - 15 = 0$      $x = \frac{5}{2}, x = -\frac{3}{4}$

e)  $10x^2 - 43x - 30 = 5$      $x = 5, x = -\frac{7}{10}$

f)  $4x^2 - 8x + 2 = 7$      $x = \frac{5}{2}, x = -\frac{1}{2}$

- 1) Show algebraically that the sum of two consecutive numbers is always odd.

$$n + n + 1$$

$$2n + 1$$

$2n$  is always even, so  $2n + 1$  must always be odd.

- 2) Show algebraically that the product of two even numbers is always a multiple of four.

$$2n \times 2m$$

$$4nm$$

$4nm$  is always a multiple of 4.

- 3) Show algebraically that the square of an odd number is always odd.

$$(2n + 1)^2$$

$$4n^2 + 4n + 1$$

$$2(2n^2 + 2n) + 1$$

$2(2n^2 + 2n)$  is always even, so  $2(2n^2 + 2n) + 1$  must always be odd.

- 4) Prove, using algebra, that the difference between the squares of any two consecutive even numbers is always a multiple of four.

$$(2n + 2)^2 - (2n)^2$$

$$4n^2 + 8n + 4 - 4n^2$$

$$8n + 4$$

$4(2n + 1)$  which is always a multiple of 4.

- 5)  $n$  is an integer.

Prove that  $(2n + 1)(n + 3) + (2n + 1)(n - 2)$  is not a multiple of 2.

$$2n^2 + 7n + 3 + 2n^2 - 3n - 2$$

$$4n^2 + 4n + 1$$

$$2(2n^2 + 2n) + 1$$

$2(2n^2 + 2n)$  is even, so  $2(2n^2 + 2n) + 1$  must be odd (not a multiple of 2).

- 6) Prove that  $(4n + 1)^2 - (4n - 1)^2$  is a multiple of eight for all positive integer values of  $n$ .

$$(16n^2 + 8n + 1) - (16n^2 - 8n + 1)$$

$$16n^2 + 8n + 1 - 16n^2 + 8n - 1$$

$$16n$$

$8(2n)$  which is always a multiple of 8.

- 7) Prove algebraically that the sum of the squares of any three consecutive even numbers is always a multiple of 4.

$$(2n)^2 + (2n + 2)^2 + (2n + 4)^2$$

$$4n^2 + 4n^2 + 8n + 4 + 4n^2 + 16n + 16$$

$$12n^2 + 24n + 20$$

$4(3n^2 + 6n + 5)$  which is always a multiple of 4.



1)

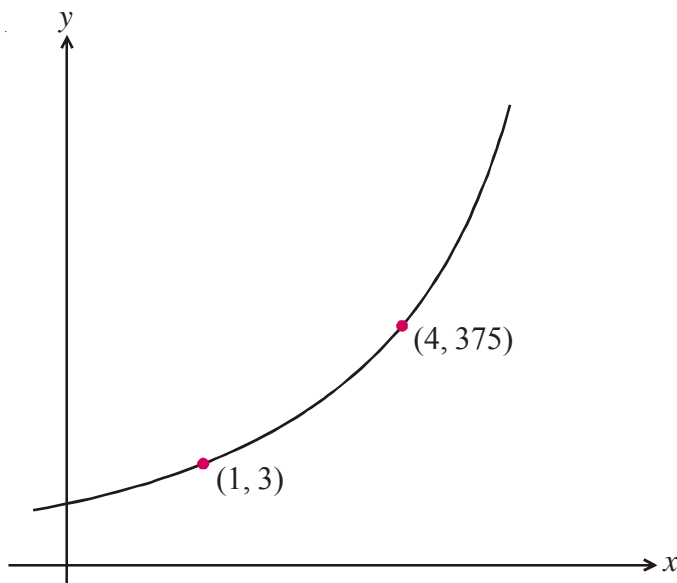

The sketch-graph shows a curve with equation  $y = pq^x$ .

The curve passes through the points (1, 3) and (4, 375).

Calculate the value of  $p$  and the value of  $q$ .  $p = 0.6$  and  $q = 5$



2) The graph shows the number of bacteria living in a petri dish. The number  $N$  of bacteria at time  $t$  is given by the relation:

$$N = a \times b^t$$

The curve passes through the point (0, 400).

a) Use this information to show that  $a = 400$ .

$$N = a \times b^t$$

$$400 = a \times b^0$$

$$400 = a \times 1$$

$$a = 400$$

The curve also passes through (2, 900).

b) Use this information to find the value of  $b$ .

$$N = 400 \times b^t$$

$$900 = 400 \times b^2$$

$$b^2 = \frac{900}{400}$$

$$b = \frac{30}{20}$$

$$b = 1.5$$

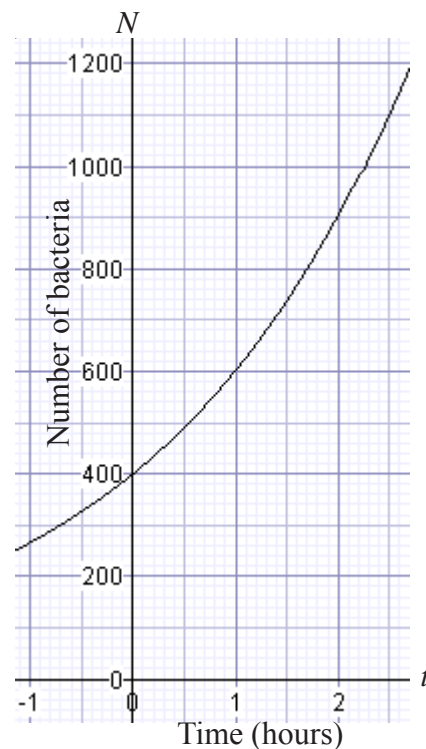

c) Work out the number of bacteria in the dish at time  $t = 3$ .  $N = 1350$

1) On the axes below, draw a sketch-graph to show  $y = \sin x$

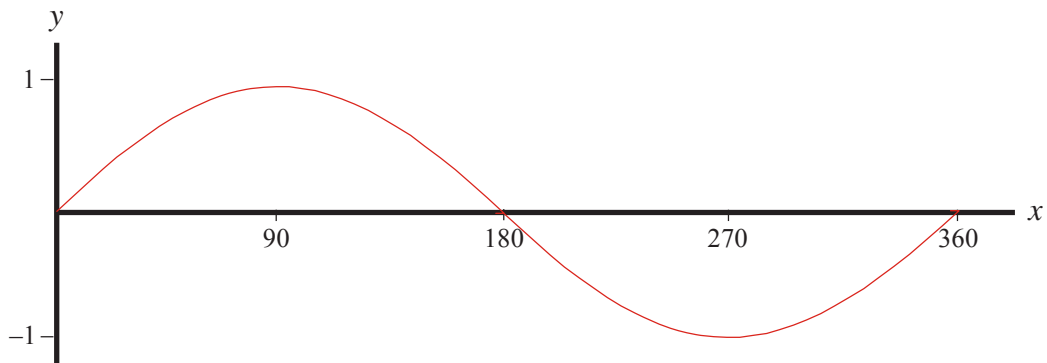

Given that  $\sin 30^\circ = 0.5$ , write down the value of:

(i)  $\sin 150^\circ$      **0.5**

(ii)  $\sin 330^\circ$      **-0.5**

2) On the axes below, draw a sketch-graph to show  $y = \cos x$

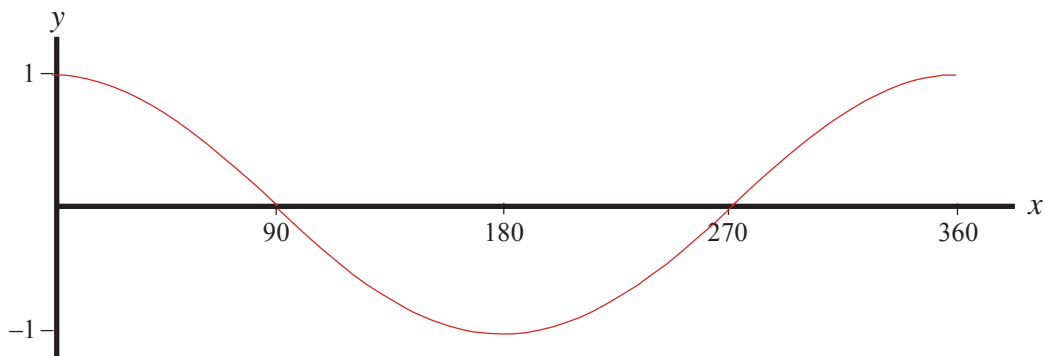

Given that  $\cos 60^\circ = 0.5$ , write down the value of:

(i)  $\cos 120^\circ$      **-0.5**

(ii)  $\cos 240^\circ$      **-0.5**

## Trigonometric Graphs

- 1) On the axes below, draw a sketch-graph to show  $y = \tan x$

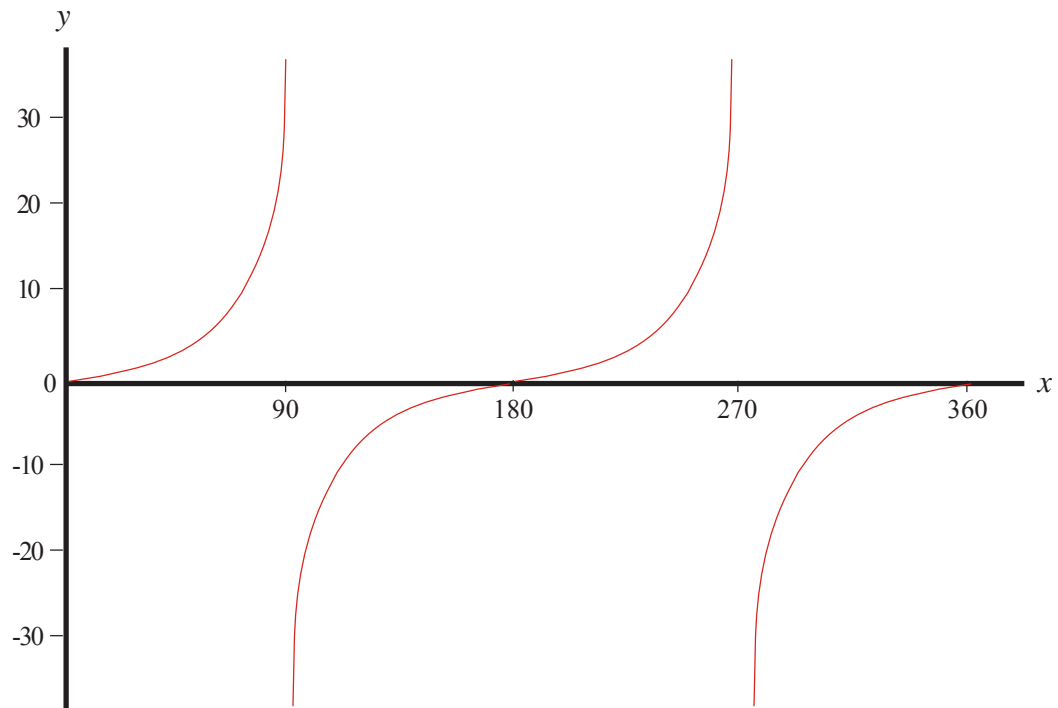

- 2) Here is the graph of the curve  $y = \cos x$  for  $0 \leq x \leq 360^\circ$ .

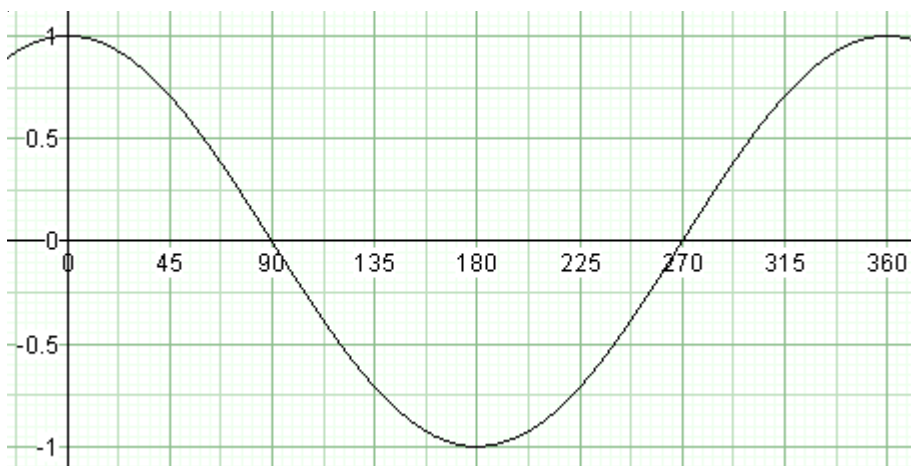

- a) Use the graph to solve  $\cos x = 0.75$  for  $0 \leq x \leq 360^\circ$   $x = 42^\circ$  and  $318^\circ$   
 b) Use the graph to solve  $\cos x = -0.75$  for  $0 \leq x \leq 360^\circ$   $x = 138^\circ$  and  $222^\circ$



1) The graph of  $y = f(x)$  is shown on the grids.

a) On this grid, sketch the graph of  $y = f(x - 3)$

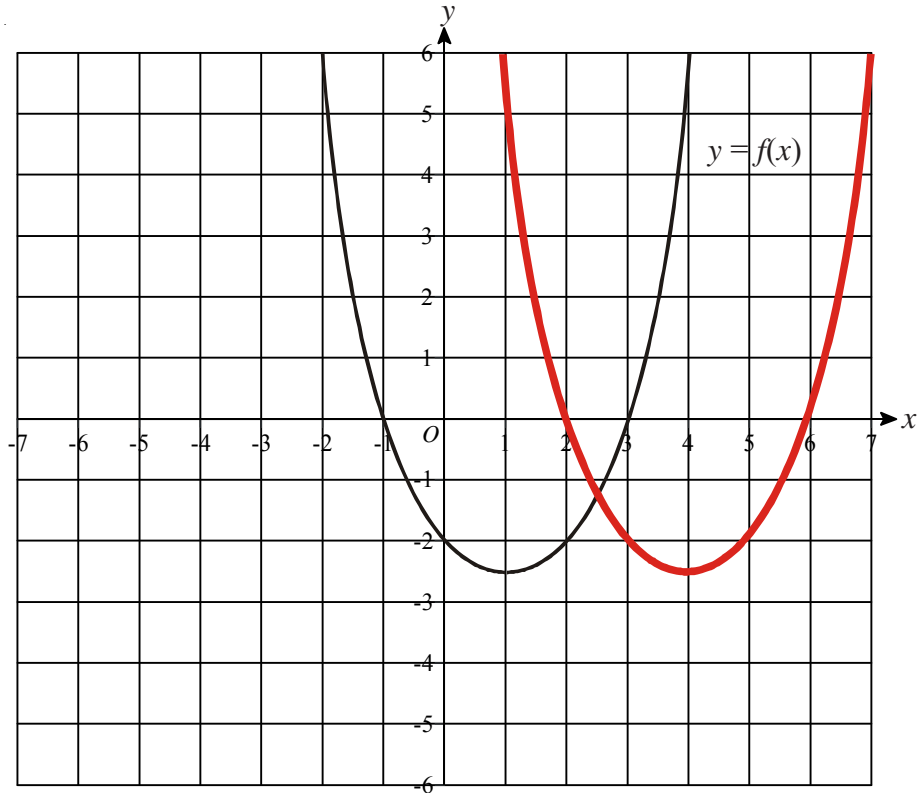

b) On this grid sketch the graph of  $y = -f(x)$

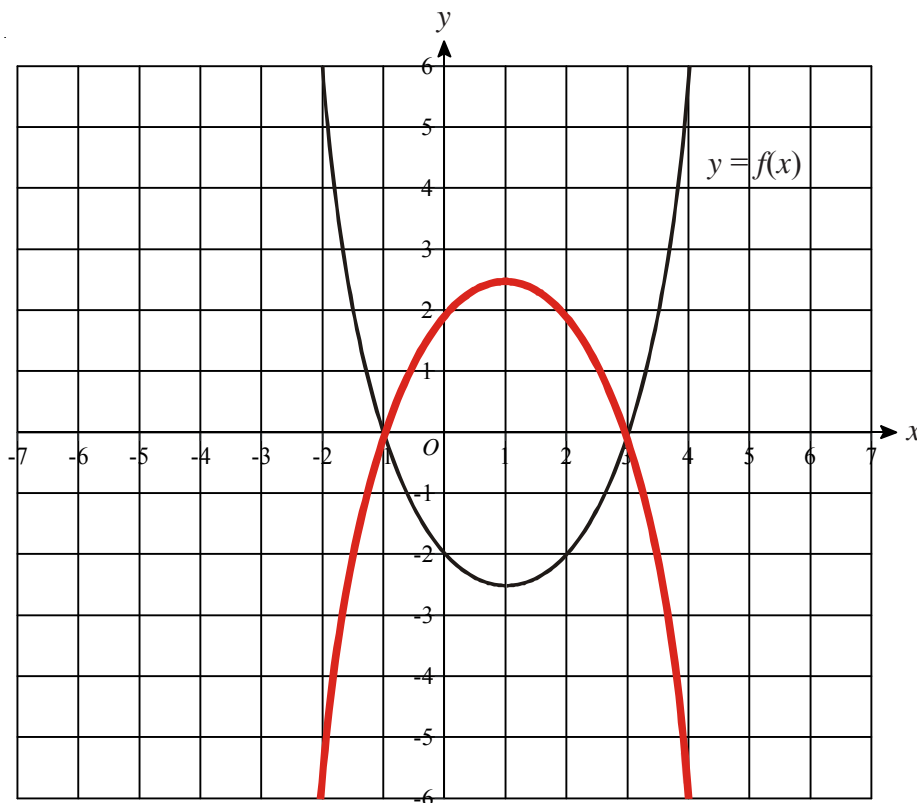

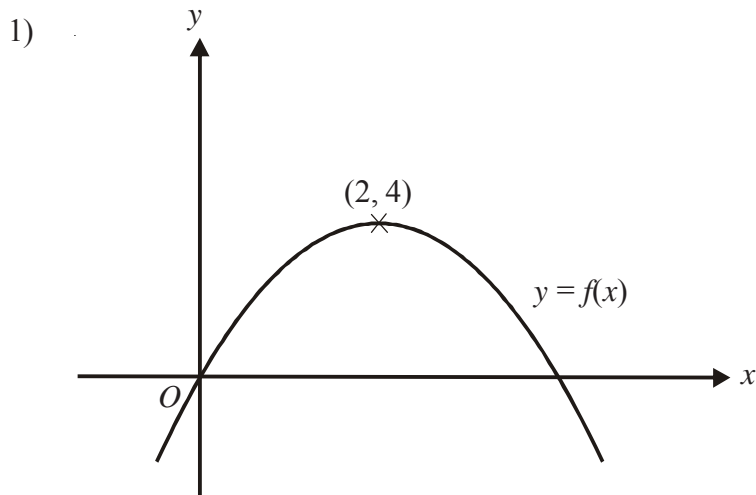

The diagram shows part of the curve with equation  $y = f(x)$ .  
The coordinates of the maximum point of this curve are  $(2, 4)$ .

Write down the coordinates of the maximum point of the curve with equation  
 $y = f(x - 2)$      **$(4, 4)$**

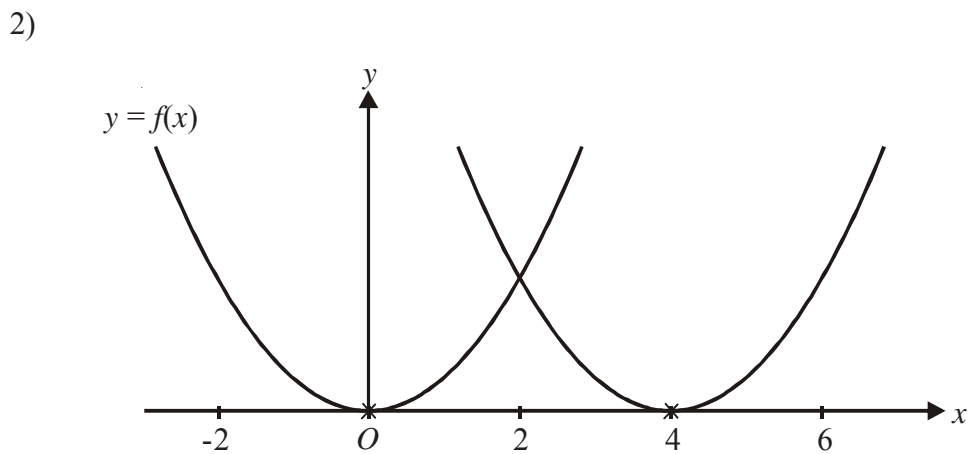

The curve with equation  $y = f(x)$  is translated so that the point at  $(0, 0)$  is mapped onto the point  $(4, 0)$ .

Find the equation of the translated curve.     **$y = f(x - 4)$**

## Transformation of Functions

- 1) The graph of  $y = f(x)$  is shown on the grid.

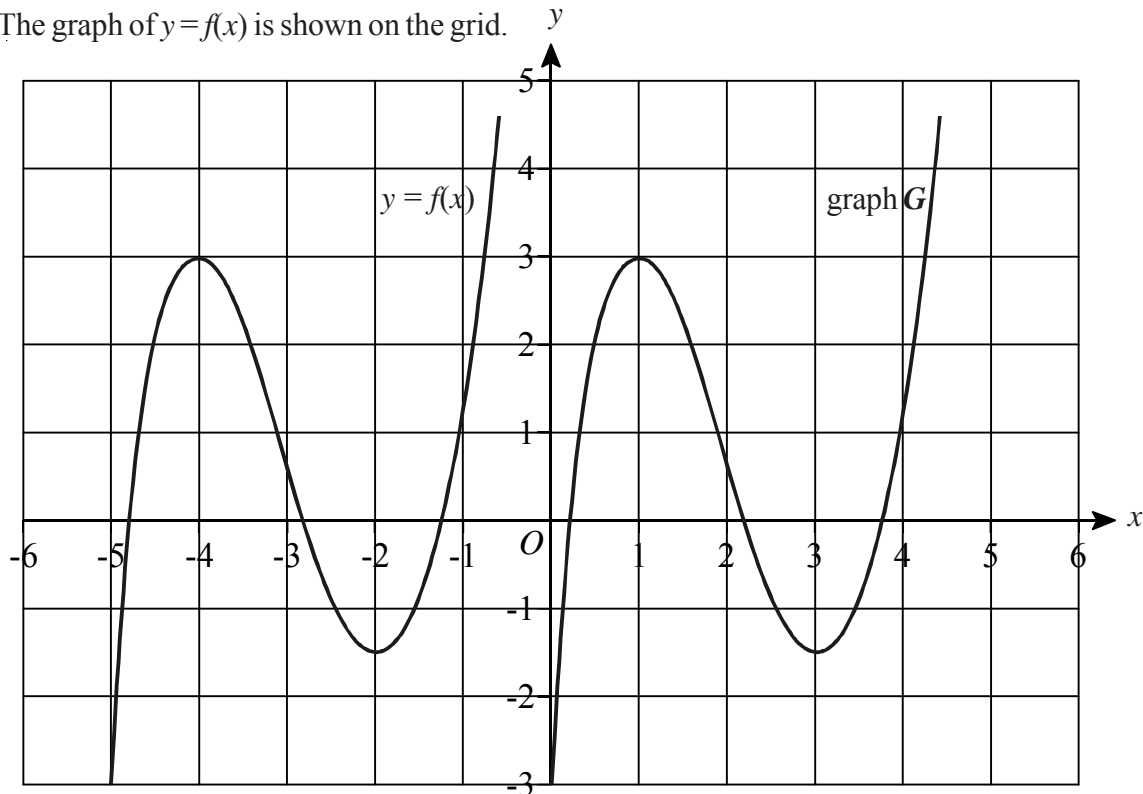

The graph  $G$  is a translation of the graph of  $y = f(x)$ .

- a) Write down, in terms of  $f$ , the equation of graph  $G$ .  $y = f(x - 5)$

The graph of  $y = f(x)$  has a maximum point at  $(-4, 3)$ .

- b) Write down the coordinates of the maximum point of the graph  $y = f(-x)$ .  $(4, 3)$

- 2) This is a sketch of the curve with the equation  $y = f(x)$ .  
The only minimum point of the curve is at  $P(3, -4)$ .

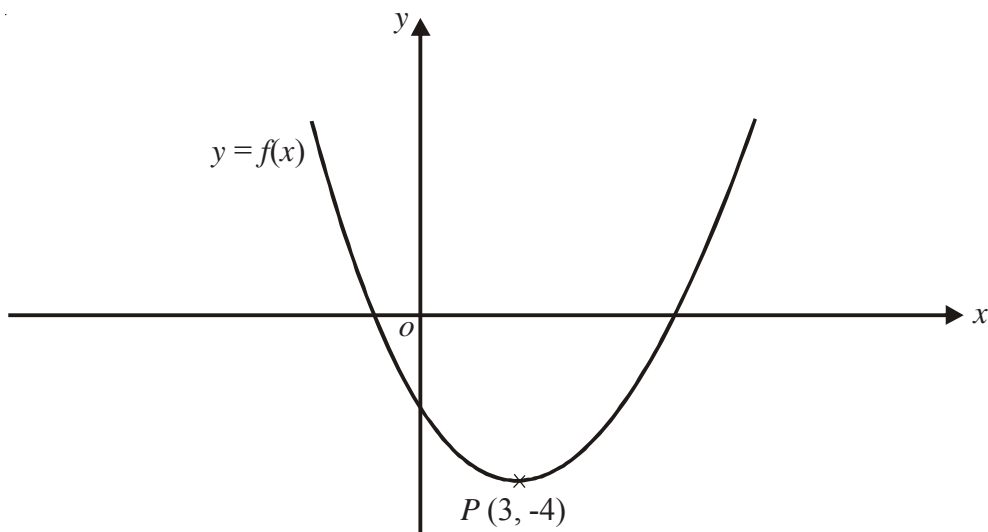

- a) Write down the coordinates of the minimum point of the curve with the equation  $y = f(x - 2)$   $(5, -4)$
- b) Write down the coordinates of the minimum point of the curve with the equation  $y = f(x + 5) + 6$   $(-2, 2)$

## Transformation of Functions

- 1) This is a sketch of the curve with equation  $y = f(x)$ .

It passes through the origin  $O$ .

The only vertex of the curve is at  $A(1, -1)$

- a) Write down the coordinates of the vertex of the curve with equation

(i)  $y = f(x - 3)$  **(4, -1)**

(ii)  $y = f(x) - 5$  **(1, -6)**

(iii)  $y = -f(x)$  **(1, 1)**

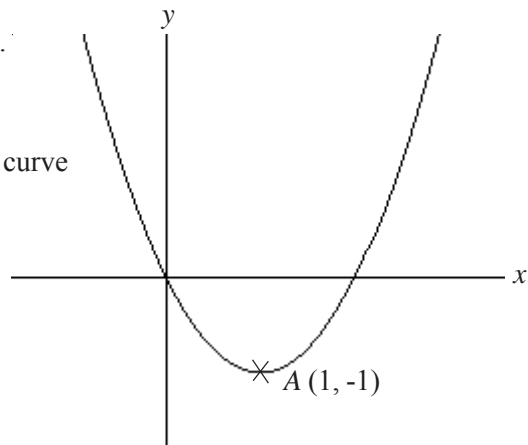

- b) The curve  $y = x^2$  has been translated to give the curve  $y = f(x)$ .

Find  $f(x)$  in terms of  $x$ .  **$y = x^2 - 2x$**

- 2) The graph of  $y = f(x)$  is shown on the grids.

On this grid, sketch the graph of  $y = f(x - 1)$

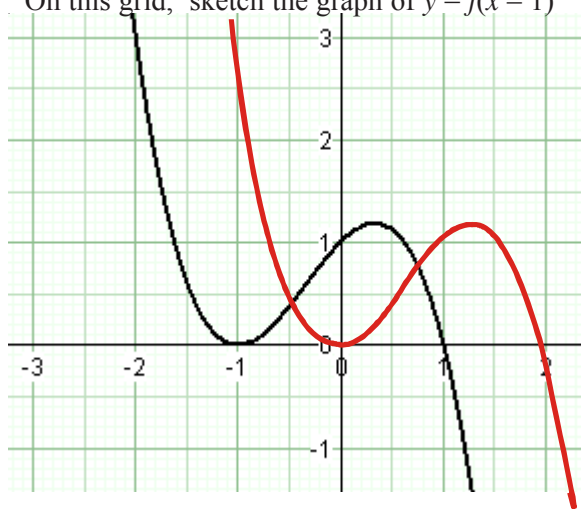

- 3) Sketch the graph of  $y = (x - 2)^2 + 3$

State the coordinates of the vertex.

**vertex is at (2, 3)**

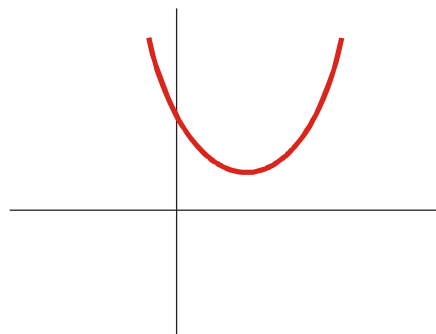

## Transformation of Functions

- 1) The diagram below shows the graph of  $y = 2 \sin x$ , for values of  $x$  between  $0$  and  $360^\circ$ .

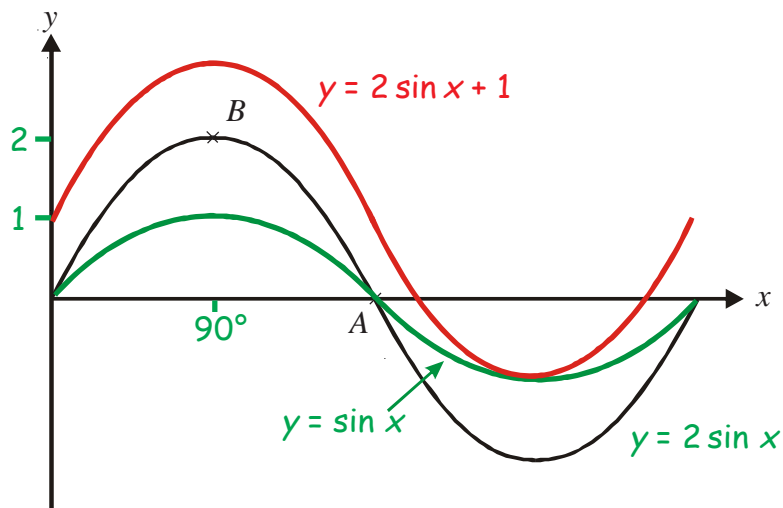

The curve cuts the  $x$  axis at the point  $A$ .  
The graph has a maximum at the point  $B$ .

- a) (i) Write down the coordinates of  $A$ .  $(180^\circ, 0)$   
 (ii) Write down the coordinates of  $B$ .  $(90^\circ, 2)$
- b) On the same diagram, sketch the graph of  $y = 2 \sin x + 1$  for values of  $x$  between  $0^\circ$  and  $360^\circ$ .

- 2) The diagram below shows the graph of  $y = \cos ax + b$ , for values of  $x$  between  $0^\circ$  and  $300^\circ$ .

Work out the values of  $a$  and  $b$ .  $a = 2$   $b = 3$

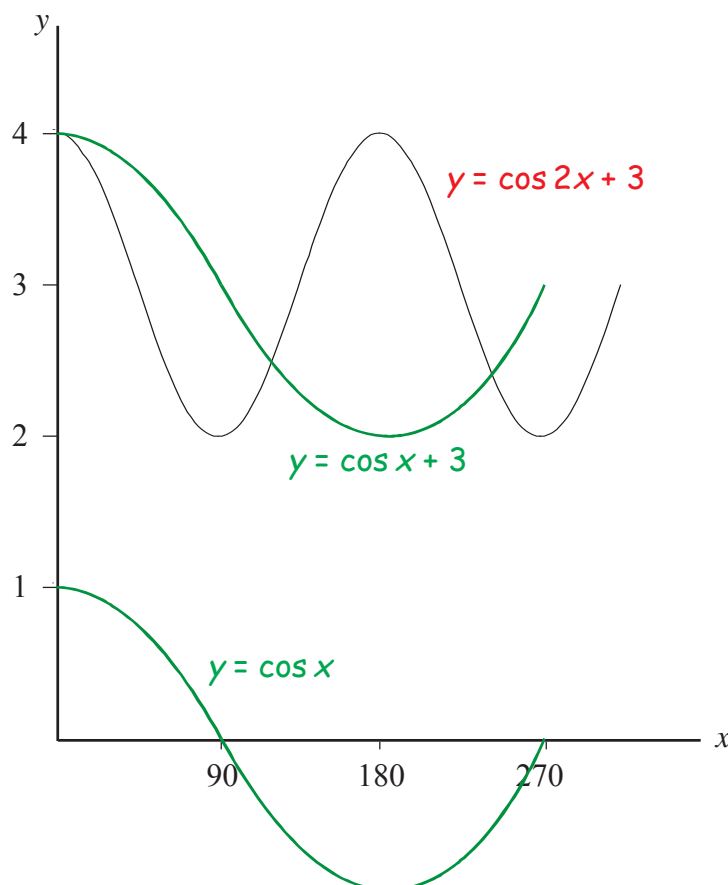

- 1) Find the equation of a circle with radius 3 and centre the origin.  $x^2 + y^2 = 9$

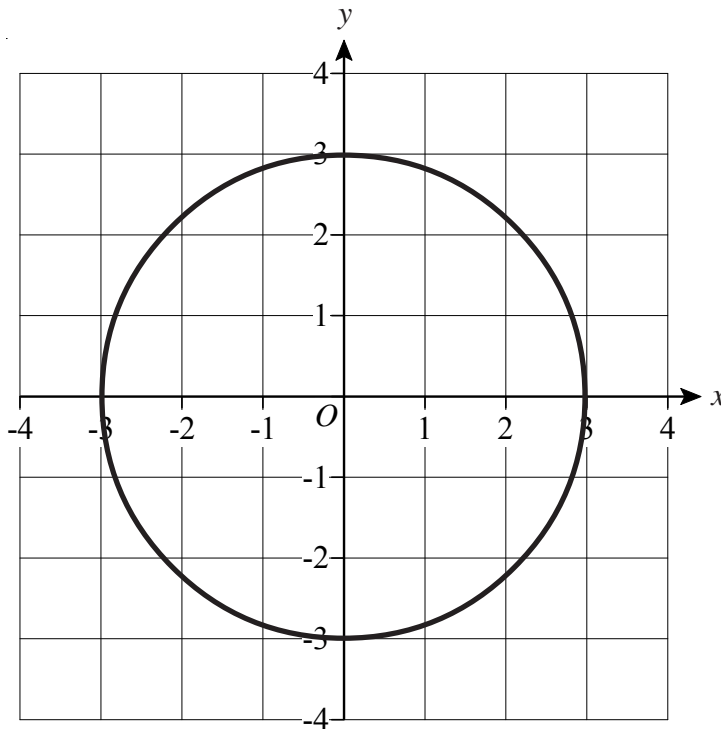

- 2) a) Draw the graph of  $x^2 + y^2 = 6.25$

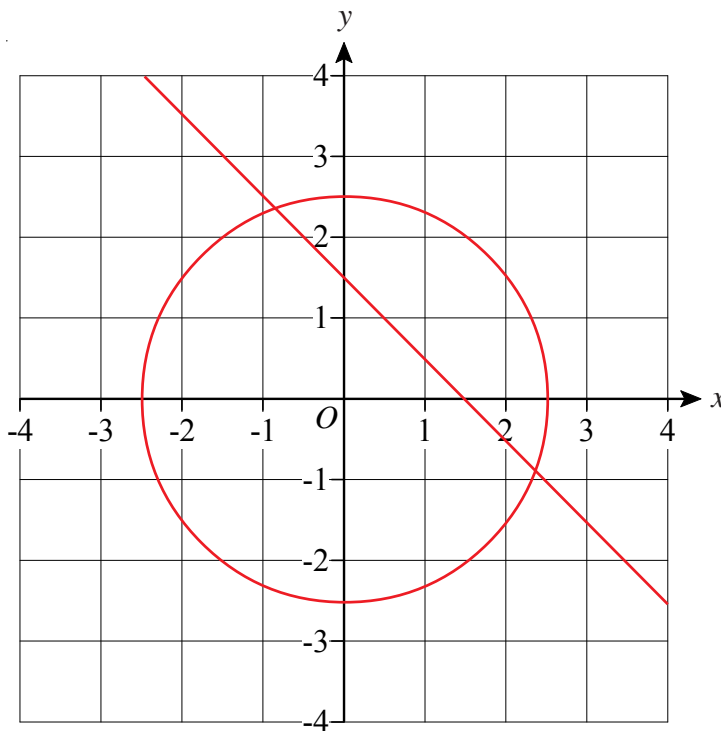

- b) By drawing the line  $x + y = 1.5$ , solve the equations

$$x^2 + y^2 = 6.25$$

$$x + y = 1.5$$

$$x = 2.3 \text{ and } y = -0.8$$

$$x = -0.8 \text{ and } y = 2.3$$

- 1) On the grid below, draw straight lines and use shading to show the region  $R$  that satisfies the inequalities  $x > 1$   $y > x$   $x + y < 7$

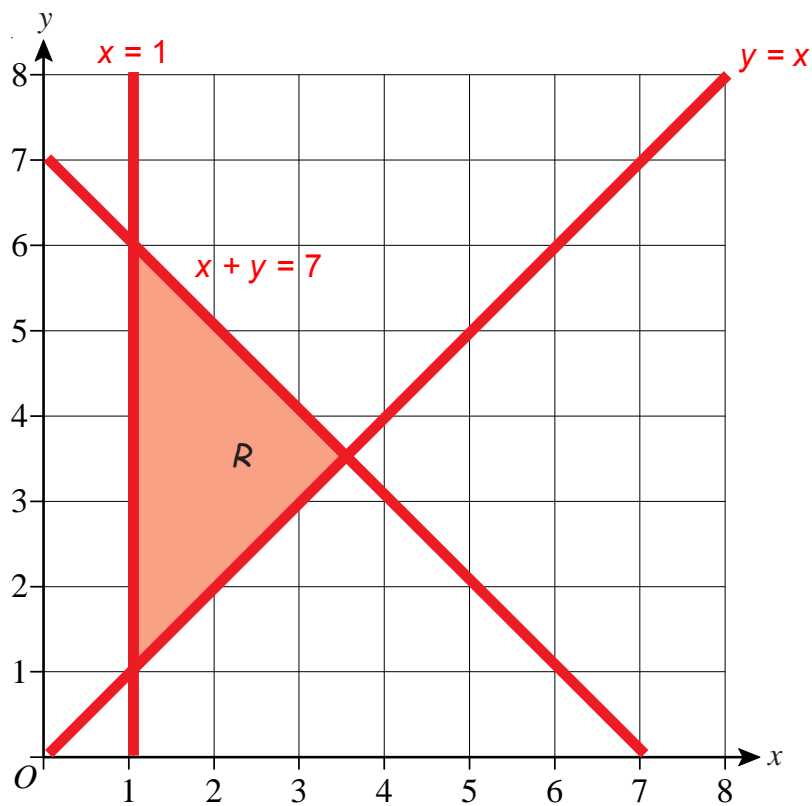

- 2) On the grid below, draw straight lines and use shading to show the region  $R$  that satisfies the inequalities  $y > x + 1$   $y < 5$   $x > 1$

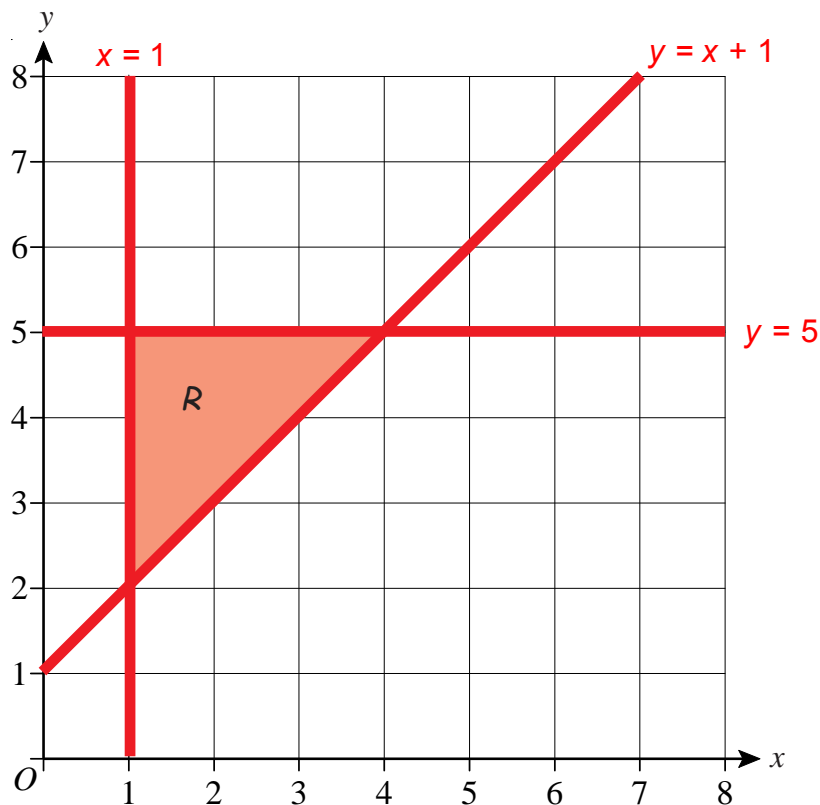

## Direct and Inverse Proportion



- 1)
- $M$
- is directly proportional to
- $L^3$
- .

When  $L = 2$ ,  $M = 160$ Find the value of  $M$  when  $L = 3$       $M = 540$ 

- 2)
- $y$
- is directly proportional to
- $x$
- .

When  $x = 500$ ,  $y = 10$ 

- a) Find a formula for  $y$  in terms of  $x$ .      $y = \frac{x}{50}$  or  $y = 0.02x$
- b) Calculate the value of  $y$  when  $x = 350$       $y = 7$



- 3)
- $D$
- is proportional to
- $S^2$
- .

 $D = 900$  when  $S = 20$ Calculate the value of  $D$  when  $S = 25$       $D = 1406.25$ 

- 4)
- $P$
- is inversely proportional to
- $V$
- .

When  $V = 8$ ,  $P = 6$ 

- a) Find a formula for  $P$  in terms of  $V$ .      $P = \frac{48}{V}$
- b) Calculate the value of  $P$  when  $V = 2$       $24$



- 5) The time,
- $T$
- seconds, for a hot sphere to cool is proportional to the square root of the surface area,
- $A$
- m
- <sup>2</sup>
- , of the sphere.

When  $A = 100$ ,  $T = 30$ .Find the value of  $T$  when  $A = 60$ .      $T = 23.2$  secs

Give your answer correct to 3 significant figures.



## Direct and Inverse Proportion

- 1)
- $x$
- is directly proportional to
- $y$
- .

When  $x = 21$ , then  $y = 3$ .

- a) Express  $x$  in terms of  $y$ .  $x = 7y$
- b) Find the value of  $x$  when  $y$  is equal to 10.  $70$

- 2)
- $a$
- is inversely proportional to
- $b$
- .

When  $a = 12$ , then  $b = 4$ .

- a) Find a formula for  $a$  in terms of  $b$ .  $a = \frac{48}{b}$
- b) Find the value of  $a$  when  $b$  is equal to 8.  $6$
- c) Find the value of  $b$  when  $a$  is equal to 4.  $12$



- 3) The variables
- $u$
- and
- $v$
- are in inverse proportion to one another.

When  $u = 3$ , then  $v = 8$ .Find the value of  $u$  when  $v = 12$ .

- 4)
- $p$
- is directly proportional to the square of
- $q$
- .

 $p = 75$  when  $q = 5$ 

- a) Express  $p$  in terms of  $q$ .  $p = 3q^2$
- b) Work out the value of  $p$  when  $q = 7$ .  $p = 147$
- c) Work out the positive value of  $q$  when  $p = 27$ .  $q = 3$



- 5)
- $y$
- is directly proportional to
- $x^2$
- .

When  $x = 3$ , then  $y = 36$ .

- a) Express
- $y$
- in terms of
- $x$
- .
- $y = 4x^2$

 $z$  is inversely proportional to  $x$ .When  $x = 4$ ,  $z = 2$ .

- b) Show that  $z = c y^n$ , where  $c$  and  $n$  are numbers and  $c > 0$ .  $z = 16y^{-0.5}$
- You must find the values of  $c$  and  $n$ .

$$c = 16$$

$$n = -0.5$$



- 1) Triangle  $ABC$  is similar to triangle  $PQR$ .

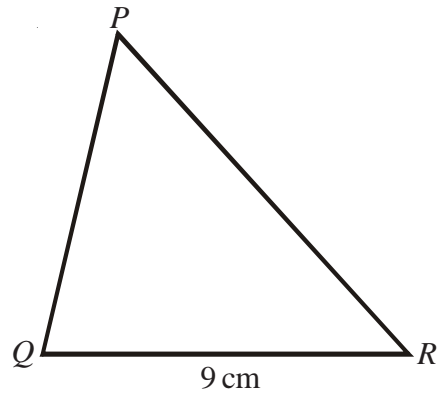
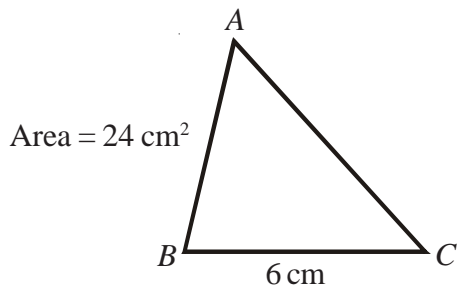

The area of triangle  $ABC$  is  $24 \text{ cm}^2$ .

Calculate the area of triangle  $PQR$ .  $54 \text{ cm}^2$



- 2) Cylinder A is mathematically similar to cylinder B.

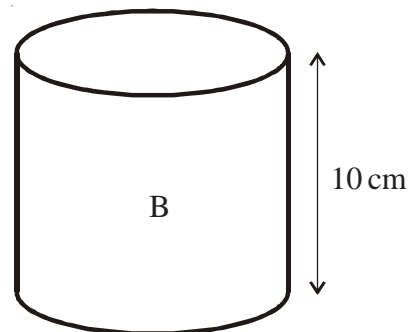
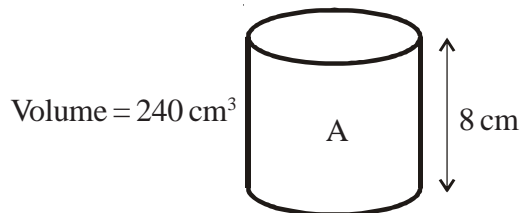

The volume of cylinder A is  $240 \text{ cm}^3$

Calculate the volume of cylinder B.  $468.75 \text{ cm}^3$



- 3) P and Q are two geometrically similar solid shapes.

The total surface area of shape P is  $540 \text{ cm}^2$ .

The total surface area of shape Q is  $2160 \text{ cm}^2$ .

The volume of shape P is  $2700 \text{ cm}^3$ .

Calculate the volume of shape Q.  $21600 \text{ cm}^3$



- 1) Work out the size of the angle marked  $x$ .  **$36.2^\circ$**   
Give your answer correct to one decimal place.

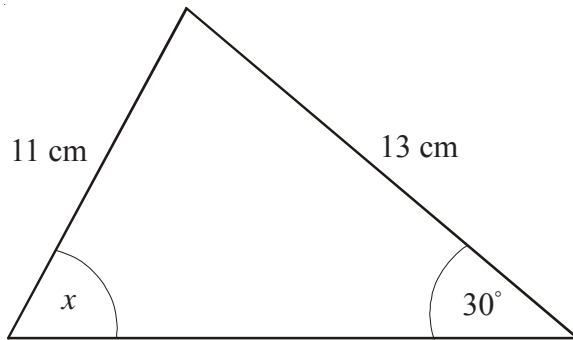

- 2) Find the missing lengths,  $x$  cm and  $y$  cm, in this triangle.  
Give your answers to 3 significant figures.

**$x = 13.9$  cm  $y = 11.3$  cm**

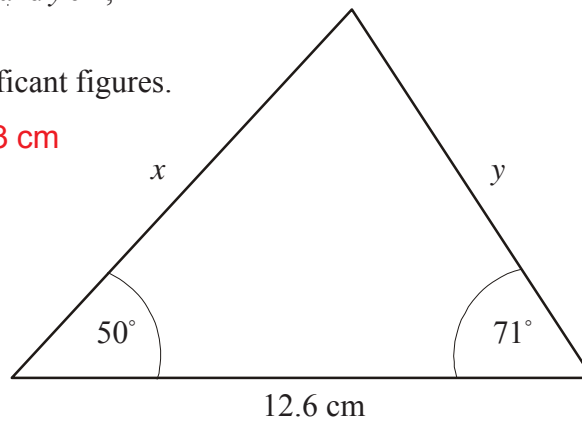

## The Cosine Rule



- 1)  $ABC$  is a triangle.  
 $AC = 8$  cm  
 $BC = 9$  cm  
 Angle  $ACB = 43^\circ$

Calculate the length of  $AB$ .  
 Give your answer correct to 3 significant figures.

**6.30 cm**

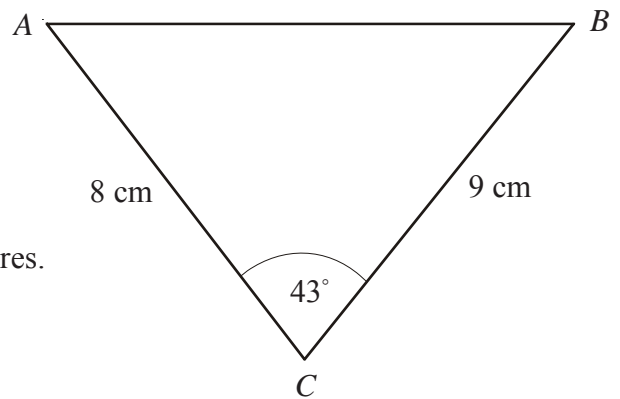

- 2) The lengths of the sides of a triangle are 4.1 cm, 5.4 cm and 7.8 cm.  
 Calculate the size of the largest angle of the triangle.  
 Give your answer correct to 1 decimal place.

**109.6°**

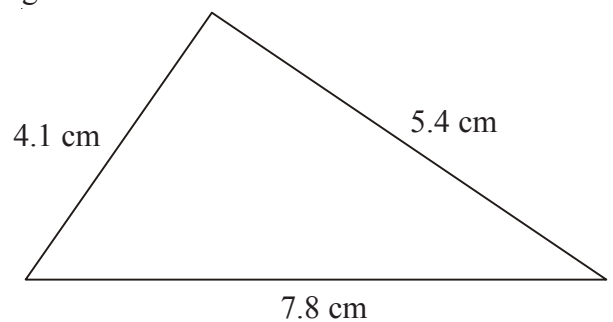

3)

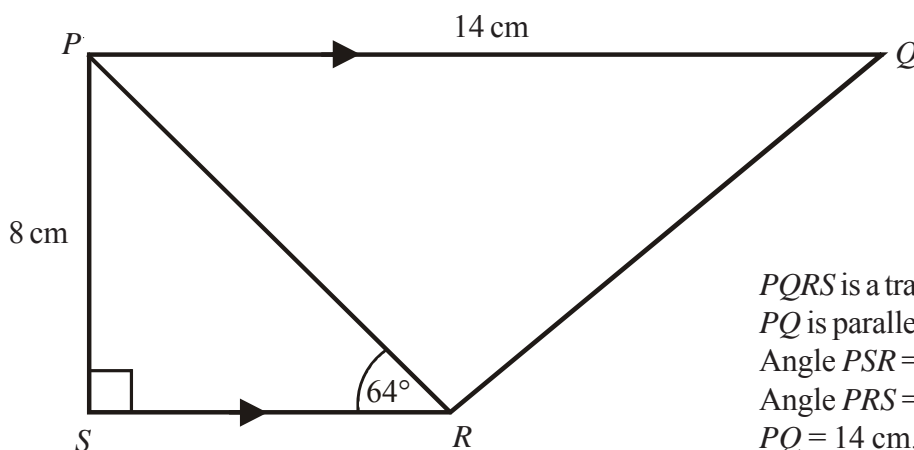

$PQRS$  is a trapezium.  
 $PQ$  is parallel to  $SR$ .  
 Angle  $PSR = 90^\circ$   
 Angle  $PRS = 64^\circ$   
 $PQ = 14$  cm.  
 $PS = 8$  cm.

- a) Work out the length of  $PR$ .  
 Give your answer correct to 3 significant figures. **8.90 cm**
- b) Work out the length of  $QR$ .  
 Give your answer correct to 3 significant figures. **12.9 cm**

## Area of a Triangle Using Sine



1)

$ABC$  is a triangle.  
 $AC = 8$  cm.  
 $BC = 10$  cm  
 Angle  $ACB = 42^\circ$

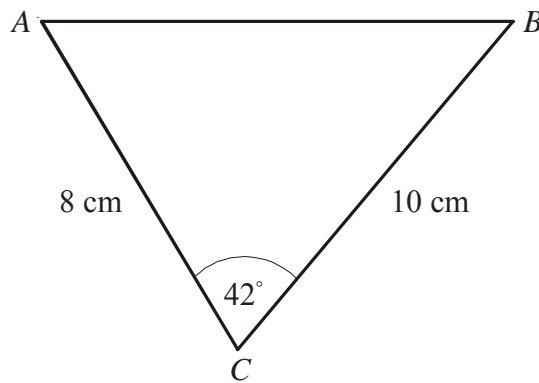

Diagram **NOT**  
accurately drawn.

Calculate the area of triangle  $ABC$ .  
 Give your answer correct to 3 significant figures.  **$26.8 \text{ cm}^2$**



2)

$ABC$  is a triangle.  
 $AB = 20$  cm.  
 $BC = 18$  cm  
 Angle  $ABC = 144^\circ$

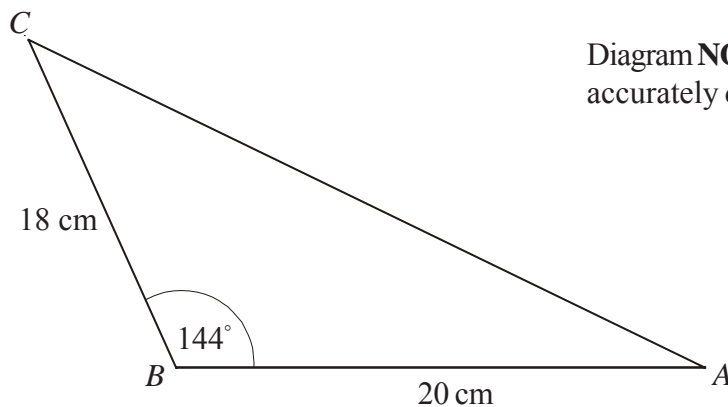

Diagram **NOT**  
accurately drawn.

Calculate the area of triangle  $ABC$ .  
 Give your answer correct to 3 significant figures.  **$106 \text{ cm}^2$**



3)

$ABC$  is a triangle.  
 $AC = 23$  cm.  
 $BC = 31$  cm  
 Angle  $BAC = 54^\circ$   
 Angle  $ABC = 39^\circ$

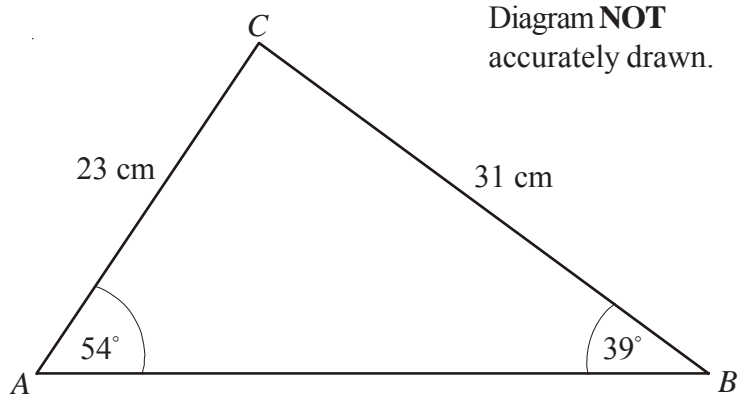

Diagram **NOT**  
accurately drawn.

Calculate the area of triangle  $ABC$ .  
 Give your answer correct to 3 significant figures.  **$356 \text{ cm}^2$**

## And and Or Probability Questions



- 1) Jordan designs a game for a school fair.  
He has two 8-sided spinners.  
The spinners are equally likely to land on each of their sides.

One spinner has 3 blue sides, 2 yellow sides and 3 white sides.  
The other spinner has 2 blue sides, 2 green sides and 4 white sides.

Calculate the probability that the two spinners will land on the same colour.  $\frac{18}{64}$



- 2) The probability that it will snow in Paris on Christmas day is 0.06.
- a) Work out the probability that it will snow in Paris on **both** Christmas day 2015 **and** Christmas day 2016.  $0.0036$
- b) Work out the probability that it will snow in Paris on **either** Christmas Day 2015 **or** Christmas Day 2016, but **not** on both.  $0.1128$



- 3) A bag contains 2 black beads, 5 yellow beads and 3 red beads.  
Natalie takes a bead at random from the bag, records its colour and replaces it.  
She does this two more times.

Work out the probability that, of the three beads Natalie takes, exactly two are the same colour.  $\frac{660}{1000}$

# Histograms

The table and histogram give some information about the weights of parcels received at a post office during one Thursday.

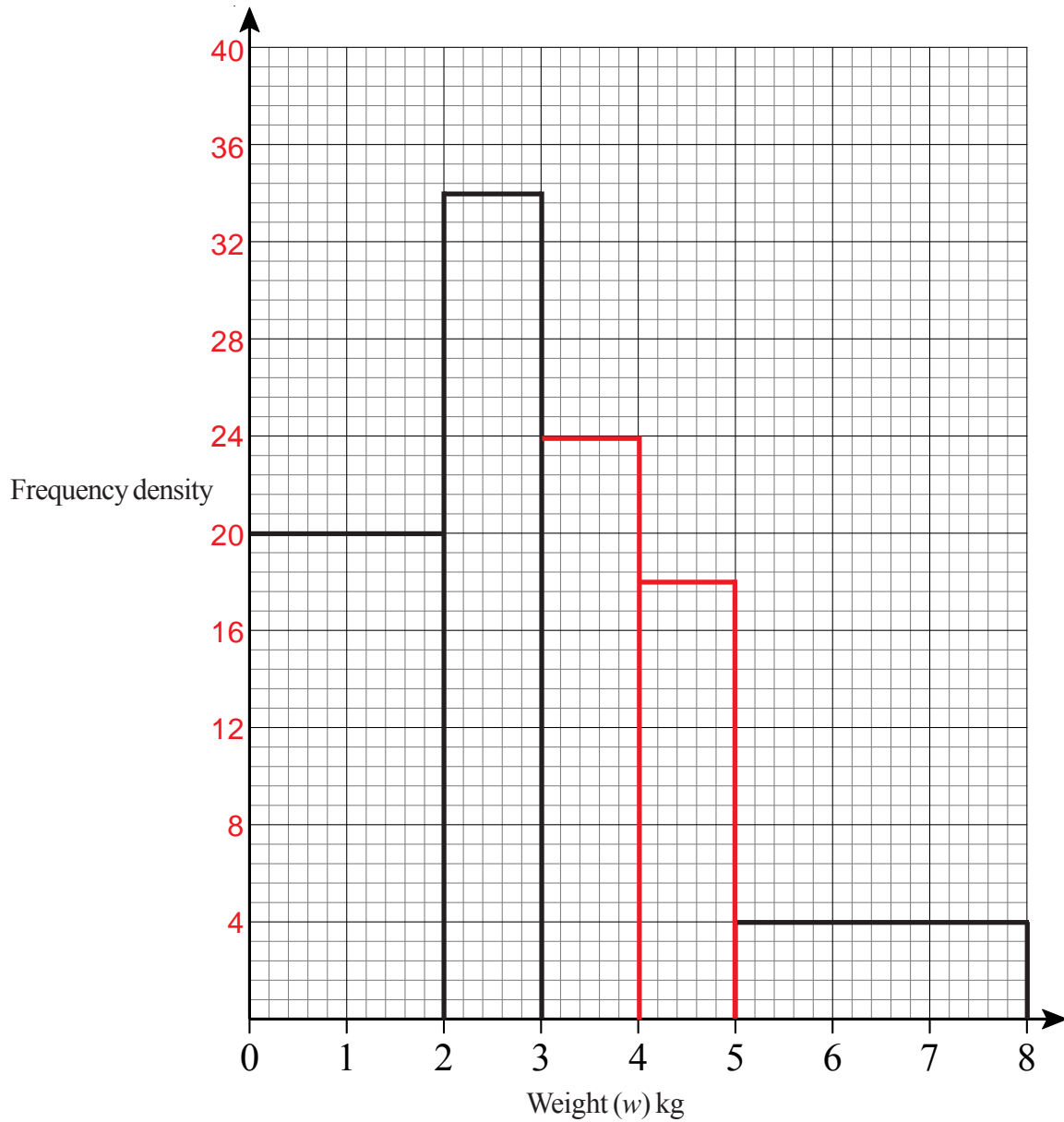

a) Use the histogram to complete the frequency table.

Weight ( $w$ ) kg	Frequency
$0 < w < 2$	40
$2 < w < 3$	34
$3 < w < 4$	24
$4 < w < 5$	18
$5 < w < 8$	12

b) Use the table to complete the histogram.

## Histograms



The incomplete table and histogram give some information about the heights (in cm) of some plants.

Height ( $h$ cm)	Frequency
$100 < h < 130$	30
$130 < h < 150$	64
$150 < h < 160$	50
$160 < h < 180$	40
$180 < h < 210$	18

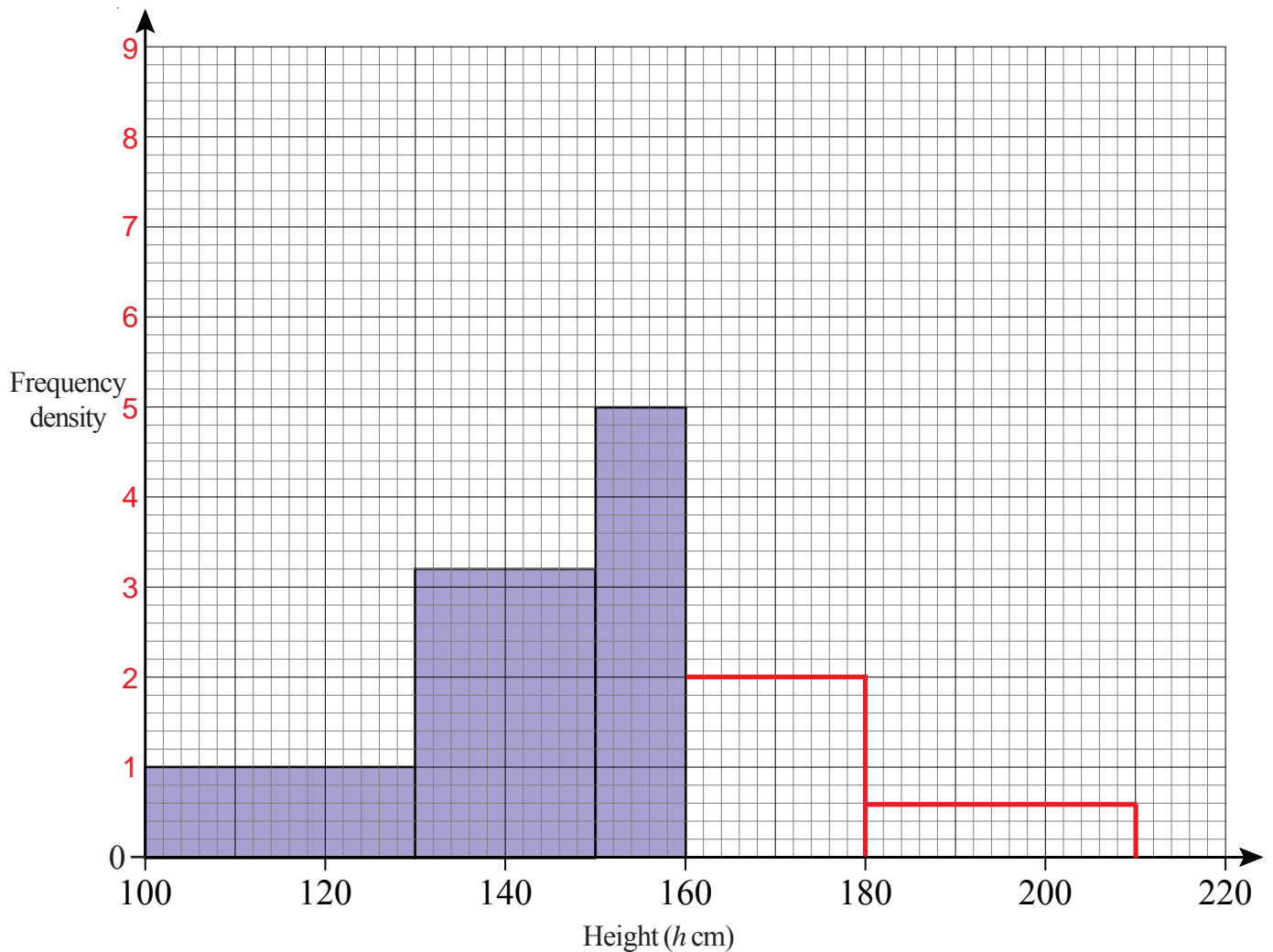

- Use the histogram to complete the table.
- Use the table to complete the histogram.



# Histograms



Paul asked the students in his class how many hours they used the internet for last week.

The incomplete histogram was drawn using his results.

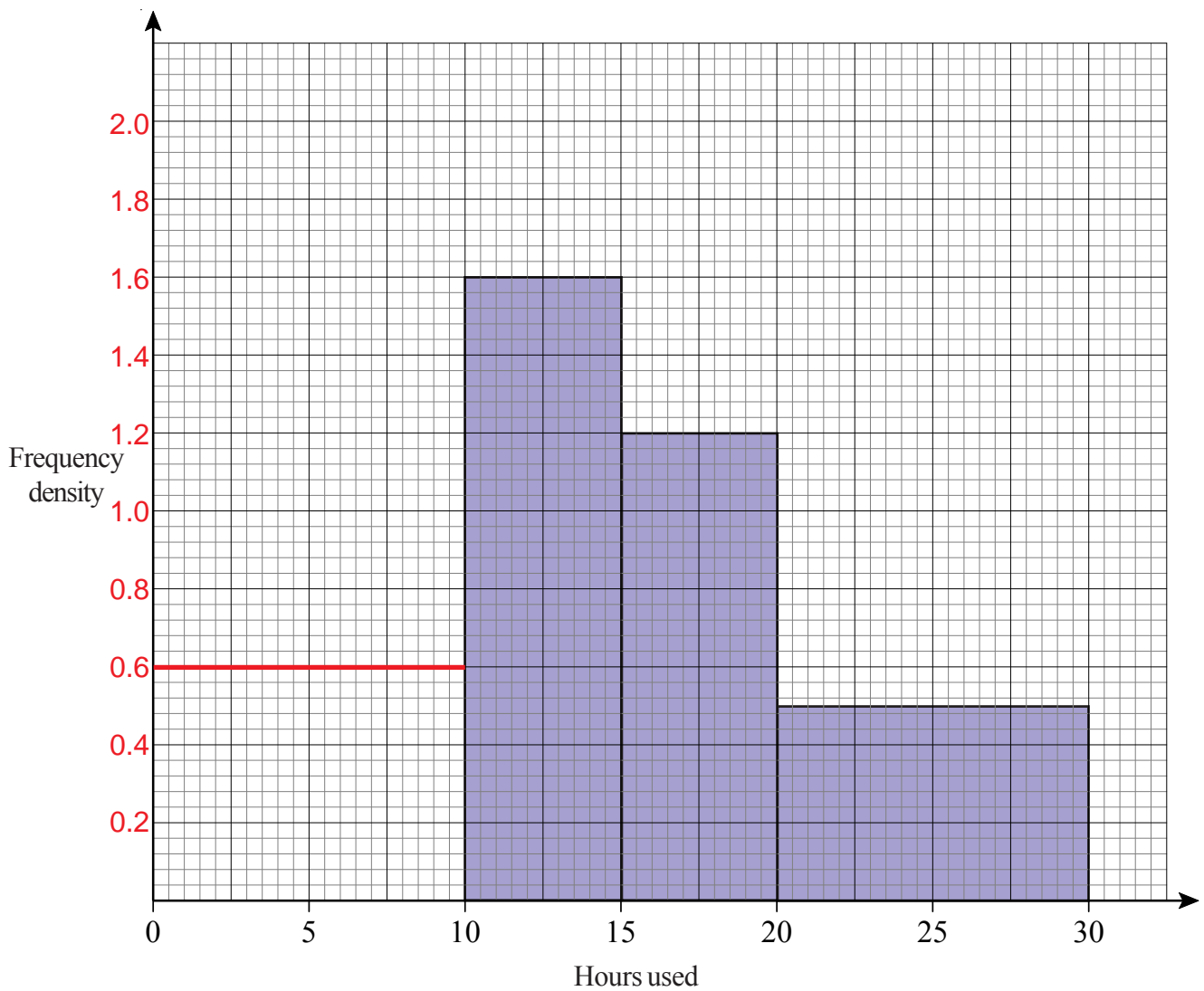

Eight students used the internet for between 10 and 15 hours.

Six students used it for between 0 and 10 hours.

a) Use this information to complete the histogram.

No students used the internet for more than 30 hours.

b) Work out how many students Paul asked.

$$6 + 8 + 6 + 5 = 25$$

# Histograms



Some trains from Nottingham to Leeds were late.  
The incomplete table and histogram give some information about how late the trains were.

Minutes late ( $t$ )	Frequency
$0 < t \leq 5$	16
$5 < t \leq 10$	10
$10 < t \leq 20$	12
$20 < t \leq 30$	6
$30 < t \leq 50$	8

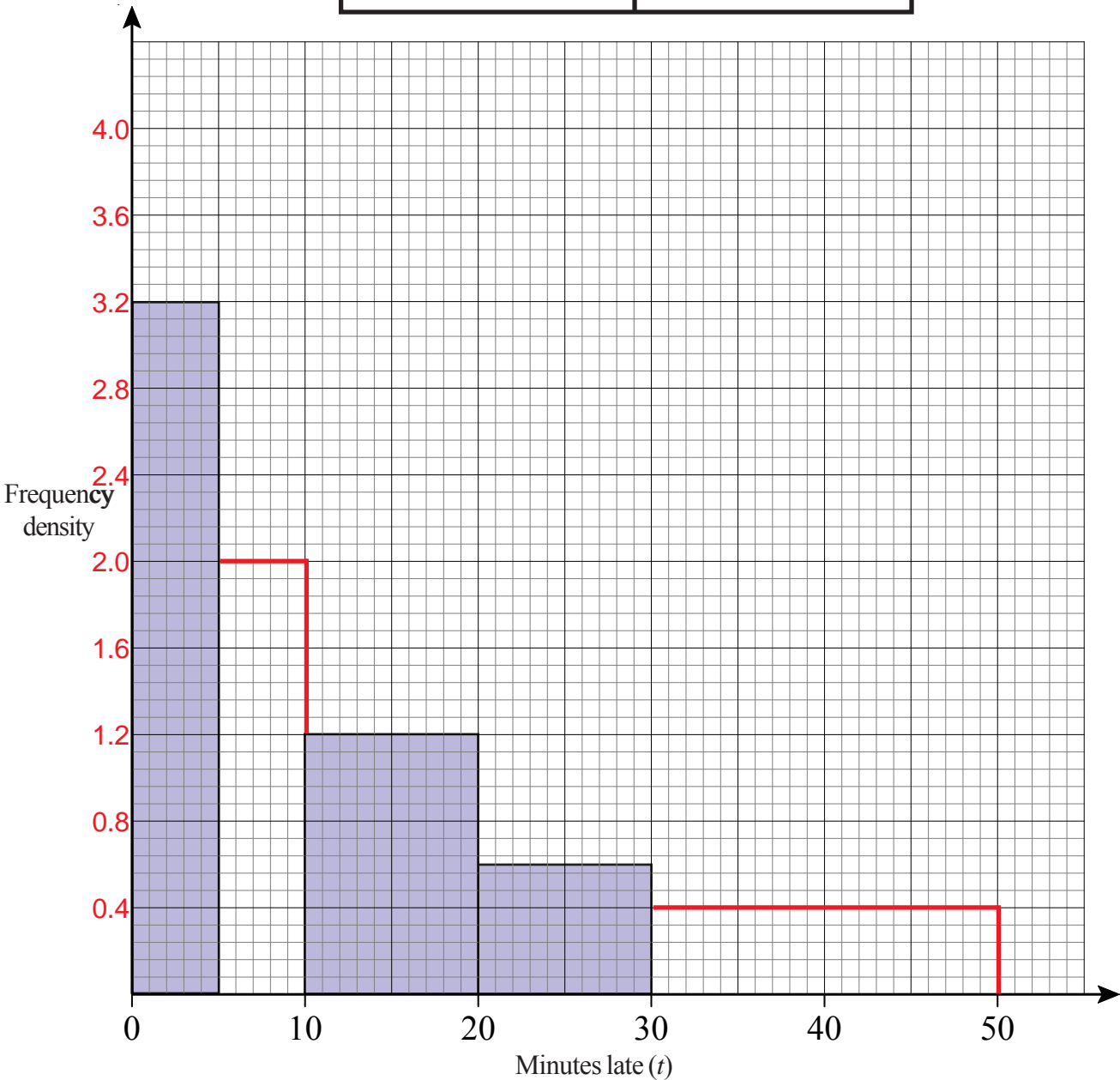

- a) Use the information in the histogram to complete the table.
- b) Use the information in the table to complete the histogram.

## Histograms



The table and histogram give information about how long, in minutes, some students took to complete a set of homework.

Time ( $t$ ) in minutes	Frequency
$0 < t \leq 10$	20
$10 < t \leq 15$	15
$15 < t \leq 30$	60
$30 < t \leq 50$	62
$50 < t \leq 60$	23

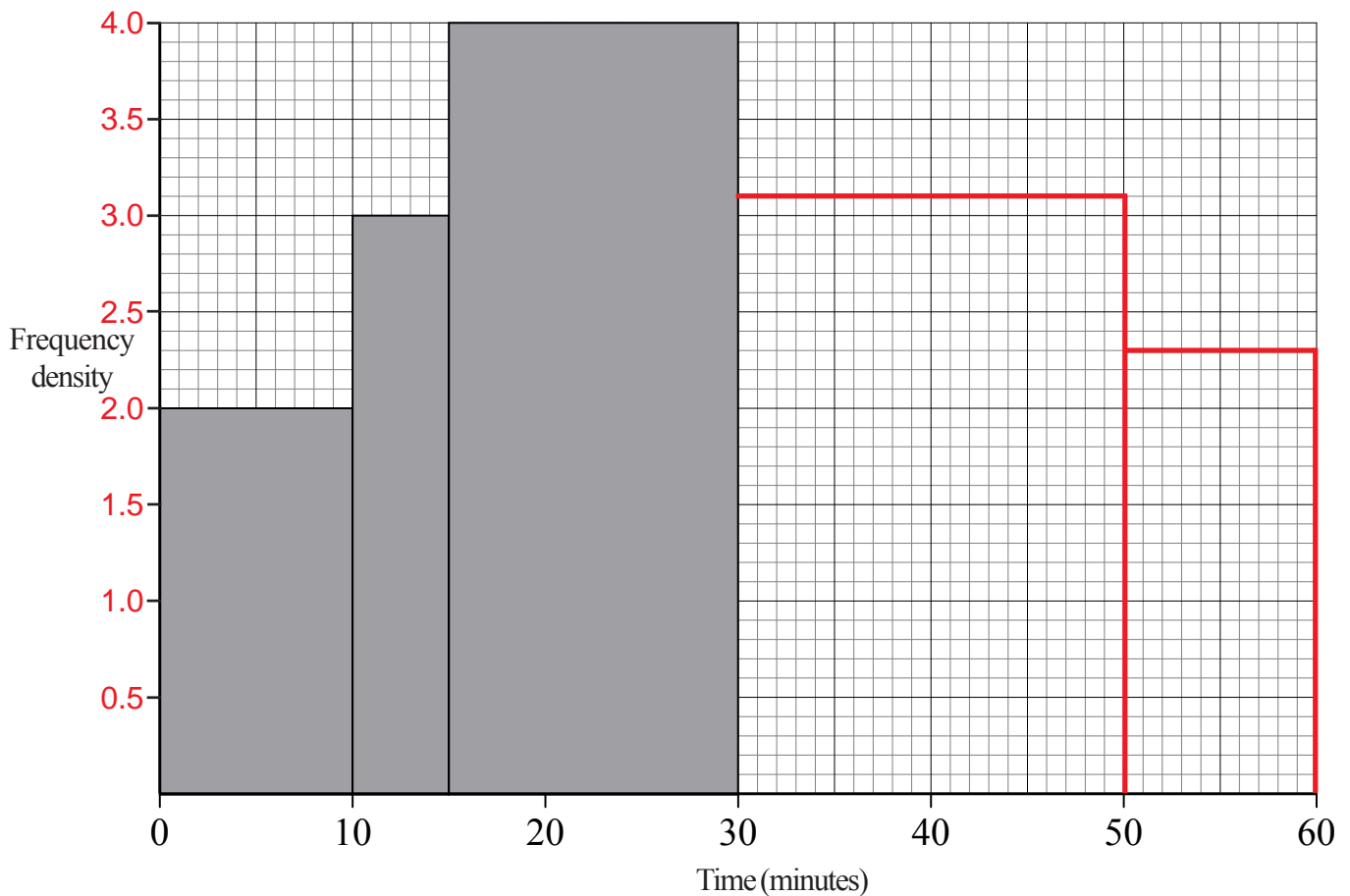

- Use the information in the histogram to complete the table.
- Use the table to complete the histogram.

## Histograms



The incomplete histogram and table give some information about the distances some students travel to school.

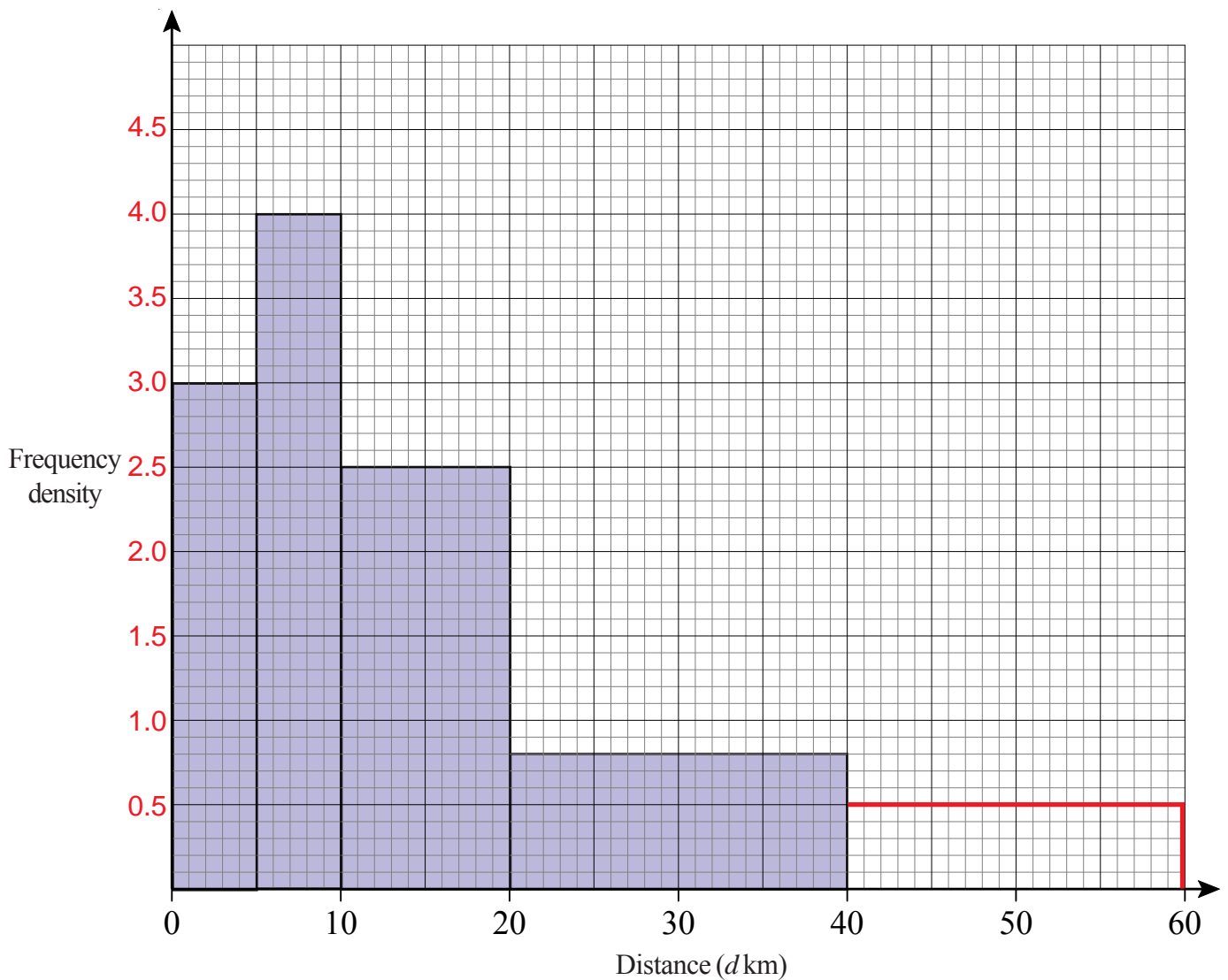

- a) Use the information in the histogram to complete the frequency table.

Distance ( $d$ km)	Frequency
$0 < d \leq 5$	15
$5 < d \leq 10$	20
$10 < d \leq 20$	25
$20 < d \leq 40$	16
$40 < d \leq 60$	10

- b) Use the information in the table to complete the histogram.

# Histograms



There are 100 pupils in Year 11. The time taken by each pupil to answer a question was recorded. The following grouped frequency distribution was obtained.

Time, $t$ seconds	$0 < t \leq 10$	$10 < t \leq 20$	$20 < t \leq 30$	$30 < t \leq 40$	$40 < t \leq 60$
Number of pupils	6	19	25	36	14

Draw a histogram to illustrate the distribution on the graph paper below.

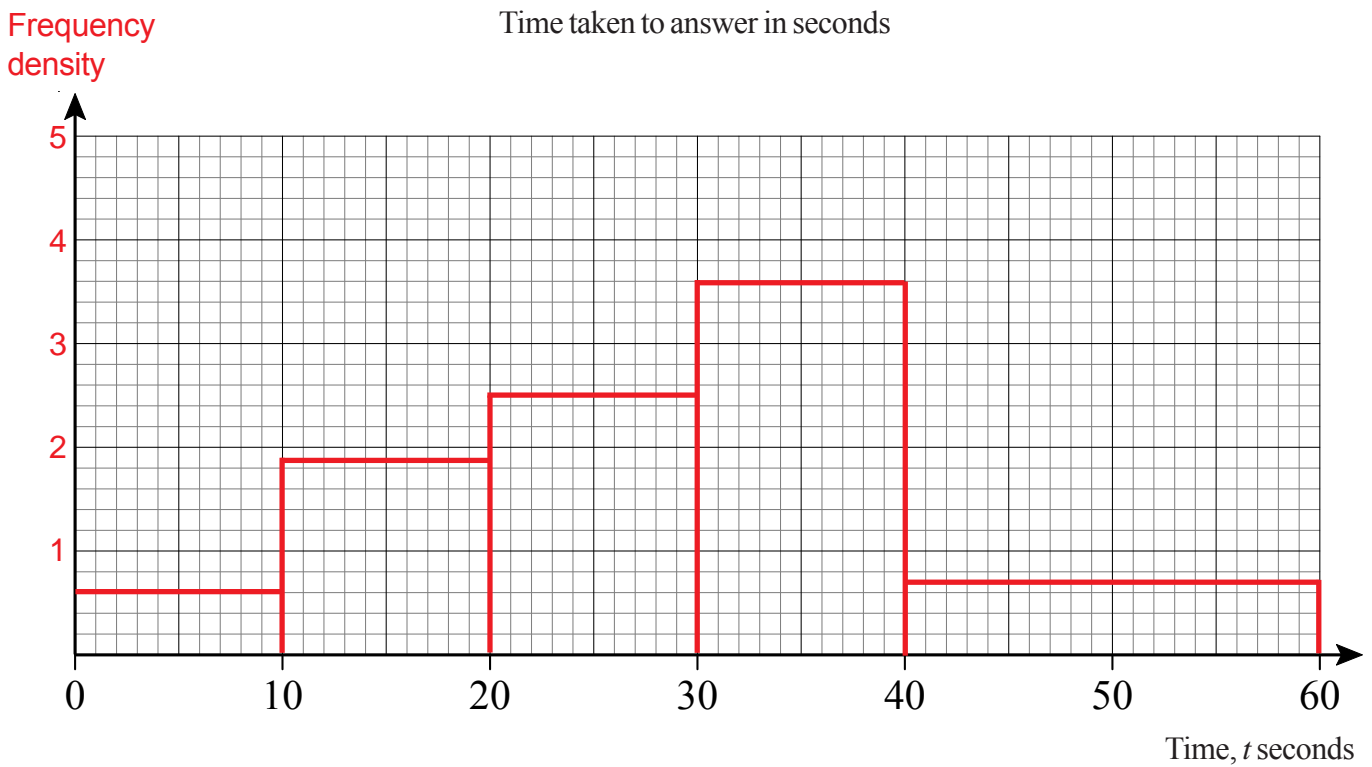

# Histograms



1) The table gives information about the heights, in centimetres, of some 18 year old students.

Height ( $h$ cm)	Frequency
$135 < h \leq 145$	12
$145 < h \leq 165$	46
$165 < h \leq 180$	45
$180 < h \leq 190$	25
$190 < h \leq 195$	4

Use the table to draw a histogram.

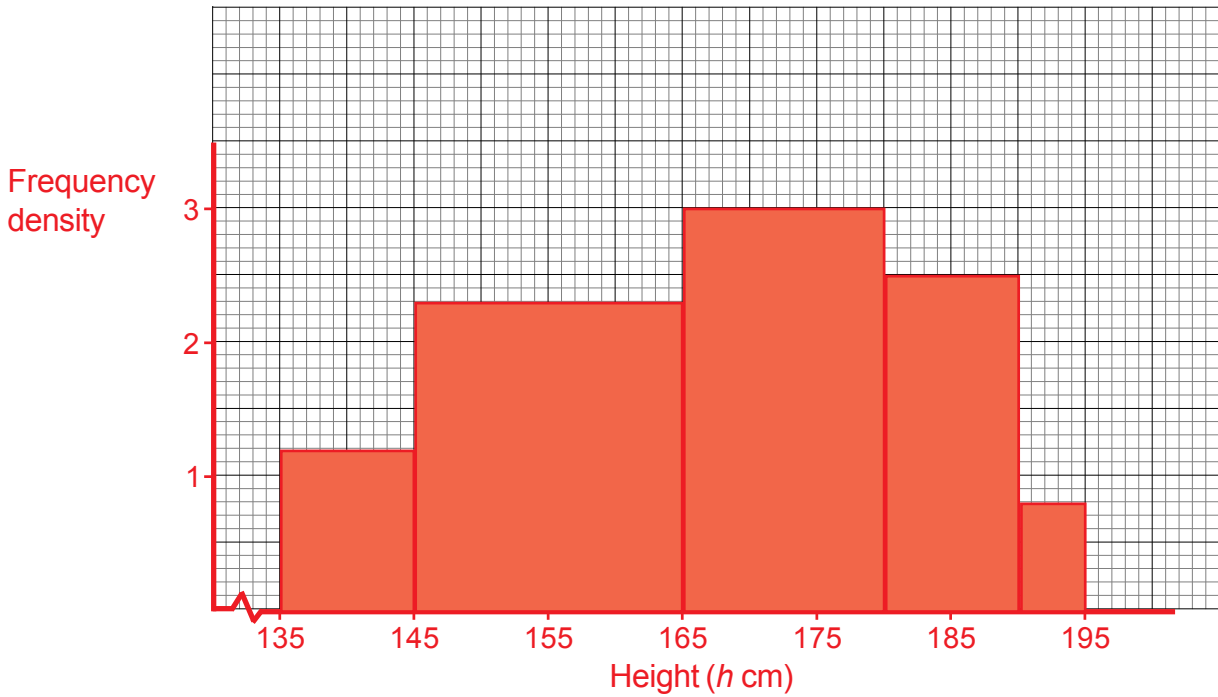

2) The histogram shows the amount of time, in hours, that students spend on their homework per week.

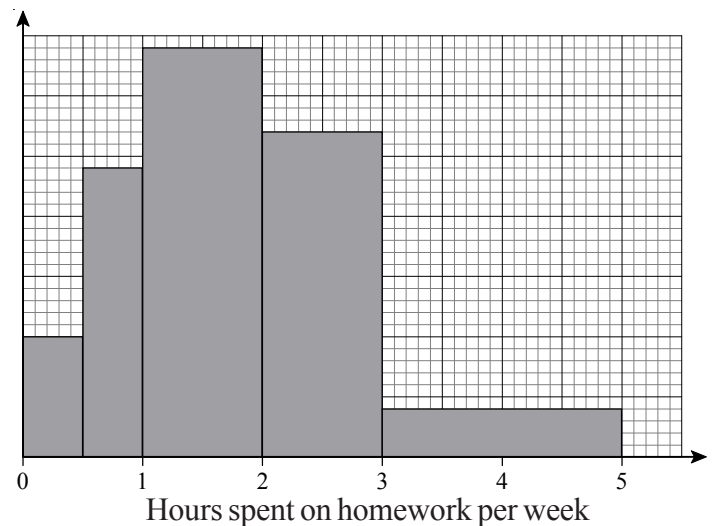

Use the histogram to complete the table.

Time ( $t$ hours)	Frequency
$0 < t \leq \frac{1}{2}$	5
$\frac{1}{2} < t \leq 1$	12
$1 < t \leq 2$	34
$2 < t \leq 3$	27
$3 < t \leq 5$	8

## Upper and Lower Bounds

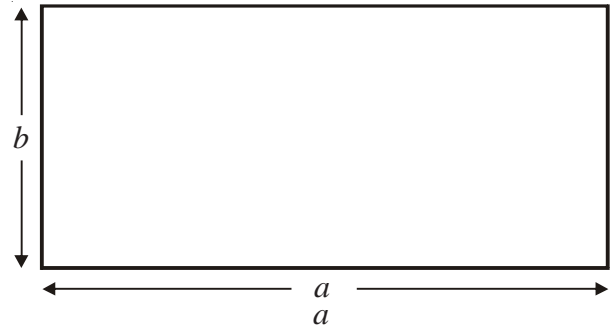

- 1) Here is a rectangle.

 $a = 8.4$  cm correct to 1 decimal place. $b = 3.6$  cm correct to 1 decimal place.

- a) Calculate the upper bound of the area of the rectangle.

Write down all the figures on your calculator.

$$8.45 \times 3.65 = 30.8425 \text{ cm}^2$$

- b) Find the area of this rectangle correct to an appropriate number of significant figures.

Lower bound for the area is  $29.6425 \text{ cm}^2$ Area =  $30 \text{ cm}^2$  correct to 1 significant figure

- 2) Terry measured the length and the width of a rectangle.

He measured the length to be 745 mm correct to the nearest 5 mm.

He measured the width to be 300 mm correct to the nearest 5 mm.

- a) Calculate the lower bound for the area of this rectangle.

Give your answer correct to 3 significant figures.

$$221000 \text{ mm}^2$$

- b) Calculate the upper bound for the perimeter of the rectangle.

$$2100 \text{ mm}$$



- 3) The voltage
- $V$
- of an electronic circuit is given by the formula

$$V = IR$$

where  $I$  is the current in ampsand  $R$  is the resistance in ohms.Given that  $V = 217$  correct to three significant figures, $R = 12.4$  correct to three significant figures,calculate the lower bound of  $I$ .

$$17.38955823 \text{ amps}$$



- 4) Sara drove for 237 miles, correct to the nearest mile.

She used 27.2 litres of petrol, to the nearest tenth of a litre.

$$\text{Petrol consumption} = \frac{\text{Number of miles travelled}}{\text{Number of litres of petrol used}}$$

Work out the upper bound for the petrol consumption for Sara's journey.

Give your answer correct to 2 decimal places.

$$8.75 \text{ miles per litre}$$



1)

The length of the rectangle,  $a$ ,  
is 45 cm correct to the nearest cm.

The width of the rectangle,  $b$ ,  
is 26 cm correct to the nearest cm.

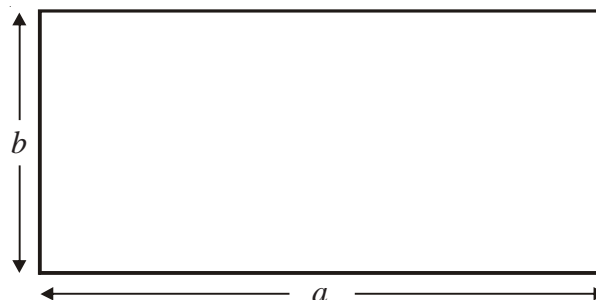

Calculate the upper bound for the area of the rectangle.

Write down all the figures on your calculator display. **1205.75 cm<sup>2</sup>**



2)

A field is in the shape of a rectangle.

The width of the field is 26 metres, measured to the nearest metre.

a) Work out the upper bound of the width of the field. **26.5 m**

The length of the field is 135 metres, measured to the nearest 5 metres.

b) Work out the upper bound for the perimeter of the field. **328 m**



3)

A ball is thrown vertically upwards with a speed  $V$  metres per second.

The height,  $H$  metres, to which it rises is given by

$$H = \frac{V^2}{2g}$$

where  $g$  m/s<sup>2</sup> is the acceleration due to gravity.

$V = 24.4$  correct to 3 significant figures.

$g = 9.8$  correct to 2 significant figures.

(i) Write down the lower bound of  $g$ . **9.75 m/s**

(ii) Calculate the upper bound of  $H$ . **30.7 m**  
Give your answer correct to 3 significant figures.



4)  $v = \sqrt{\frac{a}{b}}$

$a = 6.43$  correct to 2 decimal places.

**lower bound = 1.079402689**

$b = 5.514$  correct to 3 decimal places.

**upper bound = 1.080340323**

By considering bounds, work out the value of  $v$  to a suitable degree of accuracy.

**$v = 1.08$  correct to two decimal places or three significant figures.**

You must show all your working and give a reason for your final answer.





- 1)  $A = 11.3$  correct to 1 decimal place  
 $B = 300$  correct to 1 significant figure  
 $C = 9$  correct to the nearest integer
- Calculate the upper bound for  $A + B$ . **361.35**
  - Calculate the lower bound for  $B \div C$ . **26.3 (1dp)**
  - Calculate the least possible value of  $AC$ . **95.625**
  - Calculate the greatest possible value of  $\frac{A+B}{B+C}$  **1.4 (1dp)**



- 2) An estimate of the acceleration due to gravity can be found using the formula:

$$g = \frac{2L}{T^2 \sin x}$$

Using

$T = 1.2$  correct to 1 decimal place

$L = 4.50$  correct to 2 decimal places

$x = 40$  correct to the nearest integer

- Calculate the lower bound for the value of  $g$ .  
Give your answer correct to 3 decimal places. **8.859**
- Calculate the upper bound for the value of  $g$ .  
Give your answer correct to 3 decimal places. **10.711**



- 3) The diagram shows a triangle  $ABC$ .

$AB = 73\text{mm}$  correct to 2 significant figures.

$BC = 80\text{mm}$  correct to 1 significant figure.

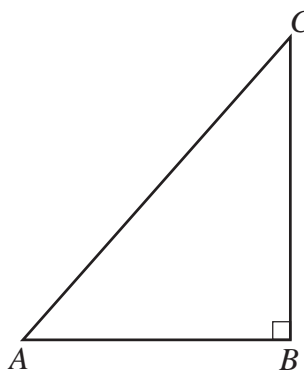

Diagram **NOT** accurately drawn

- a) Write the upper and lower bounds of both  $AB$  and  $BC$ .

$$\begin{aligned} AB_{\text{upper}} &= \underline{\underline{73.5}} \\ AB_{\text{lower}} &= \underline{\underline{72.5}} \end{aligned}$$

$$\begin{aligned} BC_{\text{upper}} &= \underline{\underline{85}} \\ BC_{\text{lower}} &= \underline{\underline{75}} \end{aligned}$$

- b) Calculate the upper bound for the area of the triangle  $ABC$ .

**3123.75**.....mm<sup>2</sup>

Angle  $CAB = x^\circ$

- c) Calculate the lower bound for the value of  $\tan x^\circ$ . **1.02 (2dp)**

## Surds

1) Simplify the following:

a)  $\sqrt{7} \times \sqrt{7}$  **7**

b)  $\sqrt{3} \times \sqrt{3}$  **3**

c)  $\sqrt{20}$   **$2\sqrt{5}$**

d)  $\sqrt{24}$   **$2\sqrt{6}$**

e)  $\sqrt{72}$   **$6\sqrt{2}$**

f)  $\sqrt{200}$   **$10\sqrt{2}$**

g)  $\sqrt{\frac{2}{25}}$   **$\frac{\sqrt{2}}{5}$**

2) Simplify the following:

a)  $\sqrt{2} \times \sqrt{18}$  **6**

b)  $\sqrt{8} \times \sqrt{32}$  **16**

c)  $\sqrt{99} \times \sqrt{22}$   **$33\sqrt{2}$**

d)  $\sqrt{45} \times \sqrt{20}$  **30**

e)  $\sqrt{18} \times \sqrt{128}$  **48**

f)  $\sqrt{28} \times \sqrt{175}$  **70**

3) Expand and simplify where possible:

a)  $\sqrt{3}(3-\sqrt{3})$   **$3\sqrt{3}-3$**

b)  $\sqrt{2}(6+2\sqrt{2})$   **$6\sqrt{2}+4$**

c)  $\sqrt{7}(2+3\sqrt{7})$   **$2\sqrt{7}+21$**

d)  $\sqrt{2}(\sqrt{32}-\sqrt{8})$  **4**

4) Expand and simplify where possible:

a)  $(1+\sqrt{2})(1-\sqrt{2})$  **-1**

b)  $(3+\sqrt{5})(2-\sqrt{5})$   **$1-\sqrt{5}$**

c)  $(\sqrt{3}+2)(\sqrt{3}+4)$   **$11+6\sqrt{3}$**

d)  $(\sqrt{5}-3)(\sqrt{5}+1)$   **$2-2\sqrt{5}$**

e)  $(2+\sqrt{7})(2-\sqrt{7})$  **-3**

f)  $(\sqrt{6}-3)^2$   **$15-6\sqrt{6}$**

5) Work out the following, giving your answer in its simplest form:

a)  $\frac{(5+\sqrt{3})(5-\sqrt{3})}{\sqrt{22}}$   **$\sqrt{22}$**

b)  $\frac{(4-\sqrt{5})(4+\sqrt{5})}{\sqrt{11}}$   **$\sqrt{11}$**

c)  $\frac{(3-\sqrt{2})(3+\sqrt{2})}{\sqrt{14}}$   **$\frac{\sqrt{14}}{2}$**

d)  $\frac{(\sqrt{3}+1)^2}{\sqrt{3}}$   **$\frac{4\sqrt{3}+6}{3}$**

e)  $\frac{(\sqrt{5}+3)^2}{\sqrt{20}}$   **$\frac{7\sqrt{5}+15}{5}$**

f)  $\frac{(5-\sqrt{5})(2+2\sqrt{5})}{\sqrt{20}}$  **4**

1)  $\sqrt{5} = 5^k$

a) Write down the value of  $k$ .  $\frac{1}{2}$

b) Expand and simplify  $(2 + \sqrt{5})(1 + \sqrt{5})$

Give your answer in the form  $a + b\sqrt{c}$   $7 + 3\sqrt{5}$

where  $a$ ,  $b$  and  $c$  are integers.

2) The diagram shows a right-angled triangle with lengths of sides as indicated.

The area of the triangle is  $A \text{ cm}^2$

Show that  $A = k\sqrt{2}$  giving the value of  $k$ .

$$\begin{aligned}
 h^2 &= 6^2 - (2\sqrt{3})^2 & \text{Area} &= \frac{2\sqrt{3} \times 2\sqrt{6}}{2} \\
 &= 36 - 12 & &= 2\sqrt{3}\sqrt{6} \\
 &= 24 & &= 2\sqrt{18} \\
 h &= \sqrt{24} & &= 6\sqrt{2} & k &= 6 \\
 h &= 2\sqrt{6} & & & &
 \end{aligned}$$

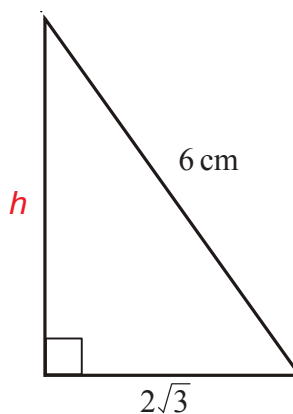

3) Given that

$$\frac{8 - \sqrt{18}}{\sqrt{2}} = a + b\sqrt{2}, \text{ where } a \text{ and } b \text{ are integers,}$$

find the value of  $a$  and the value of  $b$ .

$$\begin{aligned}
 \frac{8 - \sqrt{18}}{\sqrt{2}} \times \frac{\sqrt{2}}{\sqrt{2}} &= \frac{8\sqrt{2} - \sqrt{36}}{2} \\
 &= \frac{8\sqrt{2} - 6}{2} \\
 &= 4\sqrt{2} - 3 \\
 &= -3 + 4\sqrt{2} \\
 a &= -3 \text{ and } b = 4
 \end{aligned}$$

4) Work out  $(2 + \sqrt{3})(2 - \sqrt{3})$   $1$

Give your answer in its simplest form.

1) Rationalise the denominator, simplifying where possible:

a)  $\frac{3}{\sqrt{2}}$       $\frac{3\sqrt{2}}{2}$

b)  $\frac{2}{\sqrt{2}}$       $\sqrt{2}$

c)  $\frac{3\sqrt{2}}{\sqrt{7}}$       $\frac{3\sqrt{14}}{7}$

d)  $\frac{\sqrt{5}}{\sqrt{10}}$       $\frac{\sqrt{2}}{2}$

e)  $\frac{1}{4\sqrt{8}}$       $\frac{\sqrt{2}}{16}$

f)  $\frac{\sqrt{15}}{\sqrt{3}}$       $\sqrt{5}$

g)  $\frac{1}{\sqrt{27}}$       $\frac{\sqrt{3}}{9}$

2) Rationalise the denominator of  $\frac{1}{\sqrt{3}}$       $\frac{\sqrt{3}}{3}$

3) Rationalise the denominator of  $\frac{1}{8\sqrt{8}}$  giving the

answer in the form  $\frac{\sqrt{2}}{p}$       $\frac{\sqrt{2}}{32}$



1)

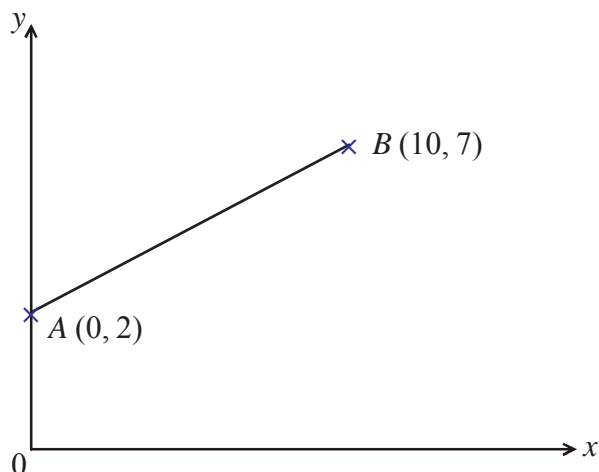

A is the point (0, 2)  
B is the point (10, 7)

- a) Write down the equation of the straight line which passes through points A and B.  $y = \frac{1}{2}x + 2$
- b) Find the equation of the line perpendicular to AB passing through B.  $y = -2x + 27$



2)

A straight line has equation  $y = 2x - 5$   
The point P lies on the straight line.  
The y coordinate of P is -6

- a) Find the x coordinate of P.  $x = -0.5$

A straight line L is parallel to  $y = 2x - 5$  and passes through the point (3, 2).

- b) Find the equation of line L.  $y = 2x - 4$
- c) Find the equation of the line that is perpendicular to line L and passes through point (3, 2).  
 $y = -\frac{1}{2}x + 3\frac{1}{2}$



3)

In the diagram A is the point (0, -2)  
B is the point (-4, 2)  
C is the point (0, 2)

- a) Find the equation of the line that passes through C and is parallel to AB.  $y = -x + 2$
- b) Find the equation of the line that passes through C and is perpendicular to AB.  $y = x + 2$

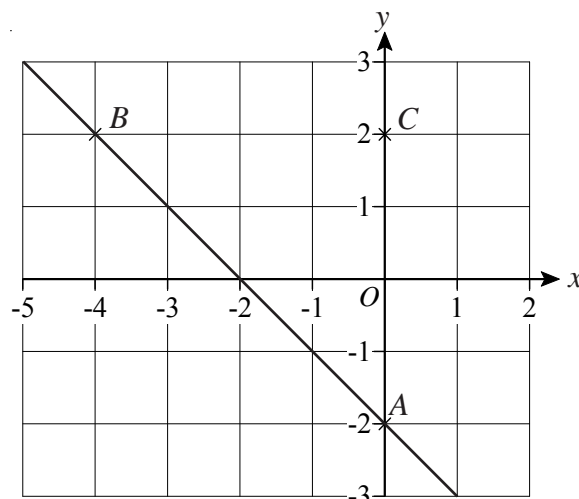

## Completing the Square

- 1) Show that if  $y = x^2 + 8x - 3$   
then  $y \geq -19$  for all values of  $x$ .

$$y = (x + 4)^2 - 16 - 3$$

$$y = (x + 4)^2 - 19$$

$$(x + 4)^2 \geq 0$$

$$y \geq -19$$

- 2) Show that if  $y = x^2 - 10x + 30$   
then  $y \geq 5$  for all values of  $x$ .

$$y = (x - 5)^2 - 25 + 30$$

$$y = (x - 5)^2 + 5$$

$$(x - 5)^2 \geq 0$$

$$y \geq 5$$

- 3) The expression  $x^2 + 4x + 10$  can be written in the form  $(x + p)^2 + q$  for all values of  $x$ .  
Find the values of  $p$  and  $q$ .

$$p = 2 \text{ and } q = 6$$

- 4) Given that  $x^2 - 6x + 17 = (x - p)^2 + q$  for all values of  $x$ ,  
find the value of  $p$  and the value of  $q$ .

$$p = 3 \text{ and } q = 8$$

- 5) For all values of  $x$ ,

$$x^2 + 6x = (x + p)^2 + q$$

- a) Find the values of  $p$  and  $q$ .  $p = 3$  and  $q = -9$

- b) Find the minimum value of  $x^2 + 6x$ .  $-9$

- 6) For all values of  $x$ ,

$$x^2 - 8x - 5 = (x - p)^2 + q$$

- a) Find the value of  $p$  and the value of  $q$ .

$$p = 4 \text{ and } q = -21$$

- b) On the axes, sketch the graph of  $y = x^2 - 8x - 5$ .

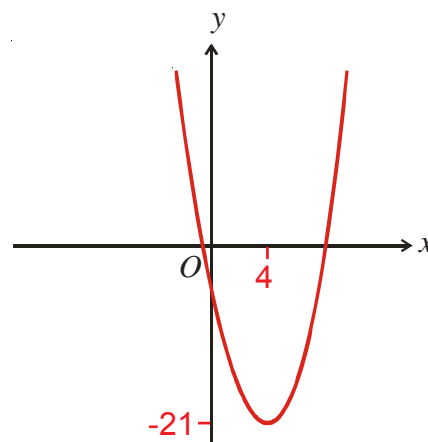

- c) Find the coordinates of the minimum point on the graph of  $y = x^2 - 8x - 5$ .

$$(4, -21)$$

- 7) The expression  $10x - x^2$  can be written in the form  $p - (x - q)^2$  for all values of  $x$ .

- a) Find the values of  $p$  and  $q$ .

$$p = 25 \text{ and } q = 5$$

- b) The expression  $10x - x^2$  has a maximum value.

- (i) Find the maximum value of  $10x - x^2$ .

$$25$$

- (ii) State the value of  $x$  for which this maximum value occurs.

$$x = 5$$

1) Simplify fully

a)  $\frac{9x^2}{21x^3} = \frac{3}{7x}$

b)  $\frac{10xy^3}{5y^2} = 2xy$

c)  $\frac{18a^3b^2}{2ab^2} = 9a^2$

d)  $\frac{4x^2 + 12x}{10x} = \frac{2(x + 3)}{5}$

e)  $\frac{2a^2b - 14a^2b^3}{6a^3b^3} = \frac{1 - 7b^2}{3ab^2}$

f)  $\frac{5x^2y + 5xy^2}{10x^2y^2} = \frac{x + y}{2xy}$

2) Simplify fully

a)  $\frac{x^2 + x}{x^2 + 6x + 5} = \frac{x}{x + 5}$

b)  $\frac{x^2 - 6x + 8}{2x^2 - 8x} = \frac{x - 2}{2x}$

c)  $\frac{x^2 + 7x + 10}{x^2 + 5x} = \frac{x + 2}{x}$

3) a) Factorise  $4x^2 - 12x + 9 = (2x - 3)^2$

b) Simplify  $\frac{6x^2 - 7x - 3}{4x^2 - 12x + 9} = \frac{3x + 1}{2x - 3}$

1) Write as single fractions in their simplest form

a)  $\frac{3}{x} + \frac{3}{2x} = \frac{9}{2x}$

b)  $\frac{5}{3x} - \frac{3}{4x} = \frac{11}{12x}$

c)  $\frac{x+2}{5} + \frac{x-1}{2} = \frac{7x-1}{10}$

d)  $\frac{3}{x+2} - \frac{5}{2x+1} = \frac{x-7}{(x+2)(2x+1)}$

2) a) Factorise  $2x^2 + 7x + 6 = (x+2)(2x+3)$

b) Write as a single fraction in its simplest form  $\frac{3}{x+2} + \frac{4x}{2x^2+7x+6} = \frac{10x+9}{(x+2)(2x+3)}$



3) Solve

a)  $\frac{1}{x} + \frac{1}{3x} = 2 \quad x = \frac{2}{3}$

b)  $\frac{1}{x-2} + \frac{3}{x+6} = \frac{1}{2} \quad x = -2 \text{ or } 6$

c)  $\frac{1}{x-5} + \frac{6}{x} = 2 \quad x = 2.5 \text{ or } 6$

d)  $\frac{7}{x+2} + \frac{1}{x-1} = 4 \quad x = -0.5 \text{ or } 1.5$

e)  $\frac{3}{x+2} + \frac{1}{x-2} = \frac{7}{x^2-4} \quad x = 2.75$

f)  $\frac{x}{2x-1} + \frac{2}{x+2} = 1 \quad x = 0 \text{ or } 3$



- 1) Solve these simultaneous equations.

$$y = x$$

$$y = x^2 - 6$$

$$x = 3 \text{ and } y = 3$$

$$x = -2 \text{ and } y = -2$$

- 2) Solve these simultaneous equations.

$$y = x^2 - 4$$

$$y = 3x$$

$$x = 4 \text{ and } y = 12$$

$$x = -1 \text{ and } y = -3$$

- 3) Solve these simultaneous equations.

$$y = x^2 - x - 13$$

$$y = x + 2$$

$$x = 5 \text{ and } y = 7$$

$$x = -3 \text{ and } y = -1$$

- 4) Solve these simultaneous equations.

$$y = x^2 - 35$$

$$x - y = 5$$

$$x = 6 \text{ and } y = 1$$

$$x = -5 \text{ and } y = -10$$

- 5) Solve these simultaneous equations.

$$x^2 + y^2 = 26$$

$$y + 6 = x$$

$$x = 5 \text{ and } y = -1$$

$$x = 1 \text{ and } y = -5$$

- 6) Sarah said that the line  $y = 7$  cuts the curve  $x^2 + y^2 = 25$  at two points.  $x^2 + 49 = 25$

- a) By eliminating  $y$  show that Sarah is **not** correct.  $x^2 = -24$

There is no solution to  $x^2 = -24$  hence  $y = 7$  does not cut the curve.

- b) By eliminating  $y$ , find the solutions to the simultaneous equations

$$x^2 + y^2 = 25$$

$$y = 3x - 9$$

$$x = 1.4 \text{ and } y = -4.8$$

$$x = 4 \text{ and } y = 3$$

$$x^2 + (3x - 9)^2 = 25$$

$$x^2 + 9x^2 - 54x + 81 = 25$$

$$10x^2 - 54x + 56 = 0$$

$$5x^2 - 27x + 28 = 0$$

$$(5x - 7)(x - 4) = 0$$

$$x = 1.4 \text{ or } x = 4$$

1) Solve the inequality  $x^2 + x - 12 \leq 0$

$$-4 \leq x \leq 3$$

2) Solve the inequality  $x^2 - 5x - 6 > 0$

$$x < -1, x > 6$$

3) Solve the inequality  $x^2 - 9 \leq 0$

$$x \leq -3, x \geq 3$$

4) Solve the inequality  $2x^2 - 13x + 15 < 0$

$$1.5 < x < 5$$

5) Solve the inequality  $6x^2 + 13x - 5 > 0$

$$x < -2.5, x > \frac{1}{3}$$

- 1) Find a formula for the  $n$ th term of this quadratic sequence:

3, 8, 15, 24, ...

$$n^2 + 2n$$

- 2) Find a formula for the  $n$ th term of this quadratic sequence:

3, 5, 9, 15, ...

$$n^2 - n + 3$$

- 3) Find a formula for the  $n$ th term of this quadratic sequence:

3, 7, 13, 21, ...

$$n^2 + n + 1$$

- 4) Find a formula for the  $n$ th term of this quadratic sequence:

1, 4, 11, 22, ...

$$2n^2 - 3n + 2$$

- 5) Find a formula for the  $n$ th term of this quadratic sequence:

2, 7, 18, 35, ...

$$3n^2 - 4n + 3$$

1) Find  $f^{-1}(x)$  if  $f(x) = \frac{x}{4} + 3$

$$f^{-1}(x) = 4(x - 3)$$

2) a) Find  $f^{-1}(x)$  where  $f(x) = 2x - 3$   $f^{-1}(x) = \frac{x + 3}{2}$

b) Find  $f^{-1}(19)$  **11**

3) a) Find  $f^{-1}(x)$  where  $f(x) = x^3 - 1$   $f^{-1}(x) = \sqrt[3]{x + 1}$

b) Find  $f^{-1}(26)$  **3**

4) Find  $f^{-1}(x)$  where  $f(x) = \frac{4x - 1}{x}$   $f^{-1}(x) = \frac{1}{4 - x}$

5) Find  $f^{-1}(x)$  where  $f(x) = \frac{2x}{x + 5}$   $f^{-1}(x) = \frac{5x}{2 - x}$

- 1) For all values of  $x$ ,

$$f(x) = x^2 - 2, \quad g(x) = x + 6$$

a) Find  $f(5)$  **23**

b) Find  $f(-1)$  **-1**

c) Find  $g(3)$  **9**

d) Find  $g(-5)$  **1**

- 2) For all values of  $x$ ,

$$f(x) = x^2 - 2, \quad g(x) = x + 6$$

a) Find  $fg(3)$  **79**

b) Find  $gf(3)$  **13**

c) Find  $gf(0)$  **4**

- 3) For all values of  $x$ ,

$$f(x) = x^2 + 3x, \quad g(x) = x + 5$$

a) Find  $fg(x)$   **$x^2 + 13x + 40$**

b) Find  $gf(x)$   **$x^2 + 3x + 5$**

- 4) For all values of  $x$ ,

$$f(x) = x + 5, \quad g(x) = x^2 - 2$$

Solve  $fg(x) = gf(x)$   **$x = -2$**

## Velocity-Time Graphs

1) The graph shows the speed of a coach between two bus stations.

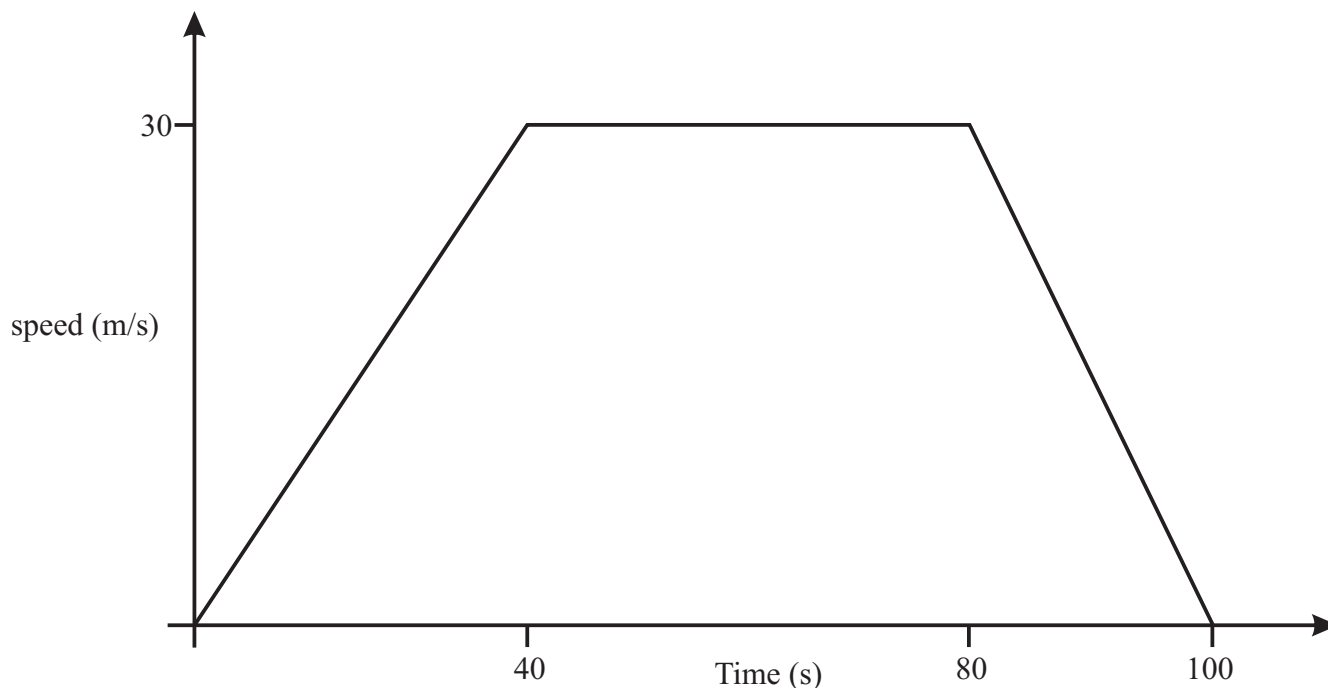

- a) What was the acceleration of the coach in  $\text{m/s}^2$  for the first 40 seconds?  **$0.75 \text{ m/s}^2$**   
 b) What is the distance, in metres, between the two stations?  **$2100 \text{ m}$**

2) The velocity-time graph for a car is shown.

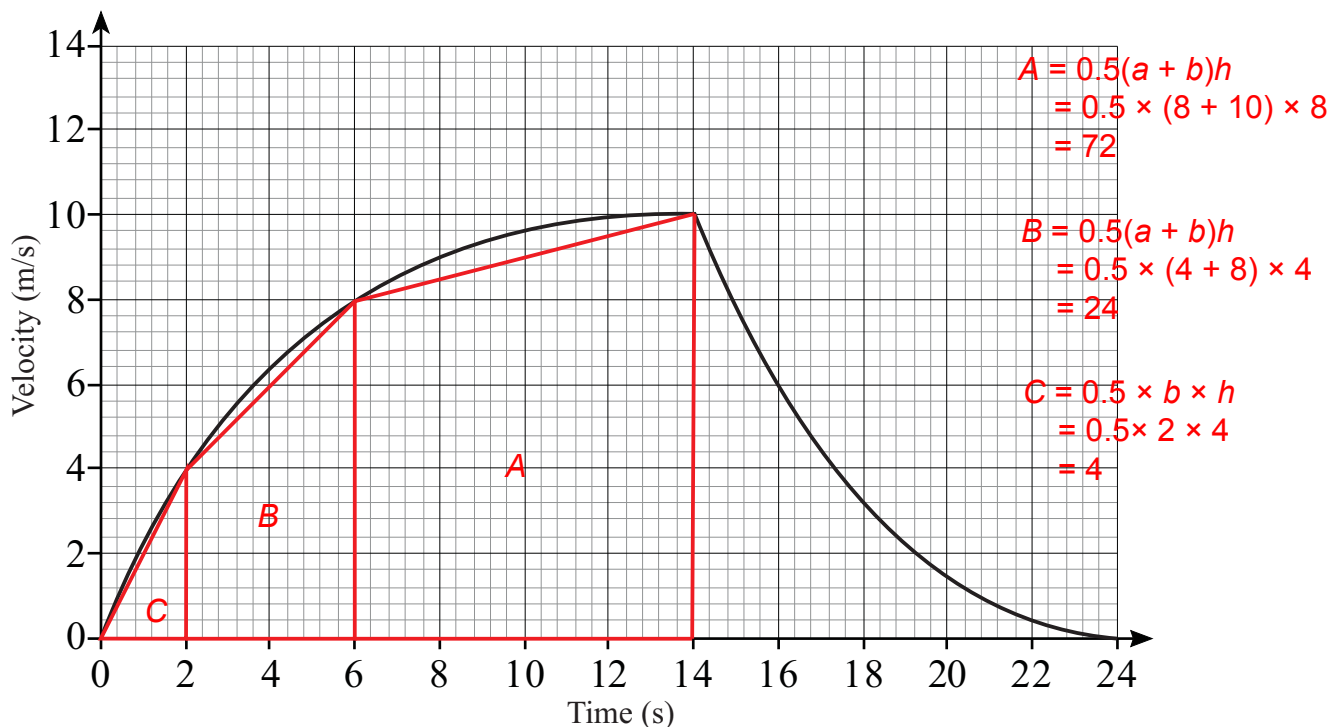

- a) Estimate the acceleration of the car at 6 seconds.  **$0.6 \text{ m/s}^2$**   
 b) Find an estimate for how far the car has travelled in the first 14 seconds.  
 Show all your working.  **$72 + 24 + 4 = 100 \text{ m}$**

## Pythagoras in 3D



- 1) The diagram shows a box in the shape of a cuboid.  
 $AB = 6\text{cm}$ ,  $BC = 4\text{cm}$ ,  $CG = 3\text{cm}$

A string runs diagonally across the box from  $A$  to  $G$ .

Calculate the length of the string  $AG$ .  
 Give your answer correct to 3 significant figures. **7.81 cm**

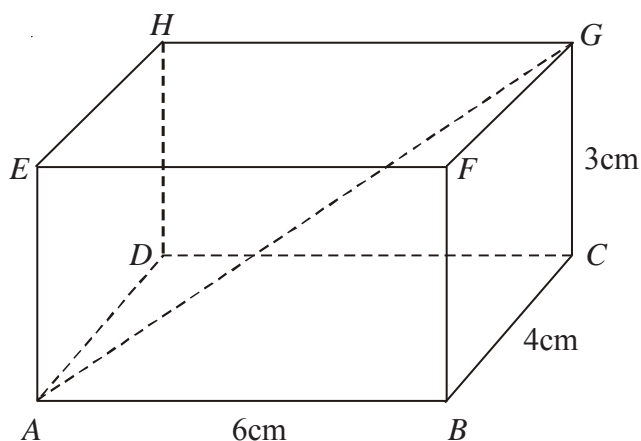

- 2) The diagram shows a box in the shape of a cuboid.  
 $AB = 8\text{cm}$ ,  $BC = 11\text{cm}$

A string runs diagonally across the box from  $D$  to  $F$  and is  $18\text{cm}$  long.

Calculate the length  $AE$ . **11.8 cm**  
 Give your answer correct to 3 significant figures.

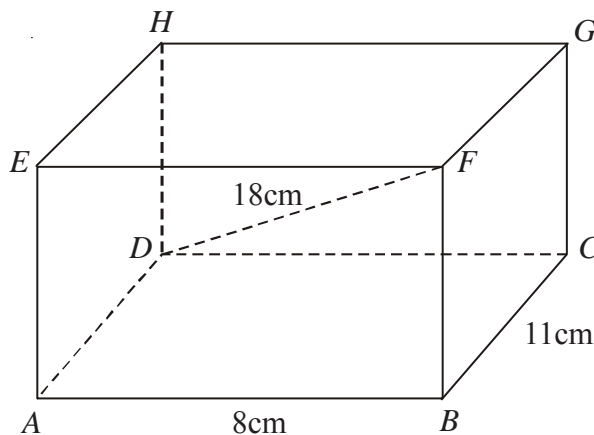

- 3) The diagram shows a wedge in the shape of a prism.  
 Angle  $BFC$  is a right angle.

String runs diagonally across the wedge from  $A$  to  $C$ .

Calculate the length  $AC$ .  
 Give your answer correct to 3 significant figures. **27.4 cm**

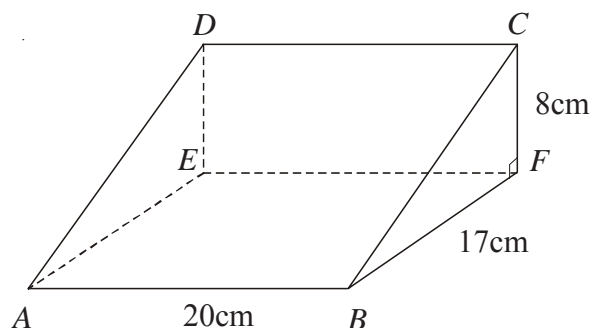



- 1) The diagram shows a wedge.  
The base of the wedge is a horizontal rectangle measuring 80 cm by 60 cm.  
The sloping face  $ABRS$  makes an angle of  $21^\circ$  to the horizontal.

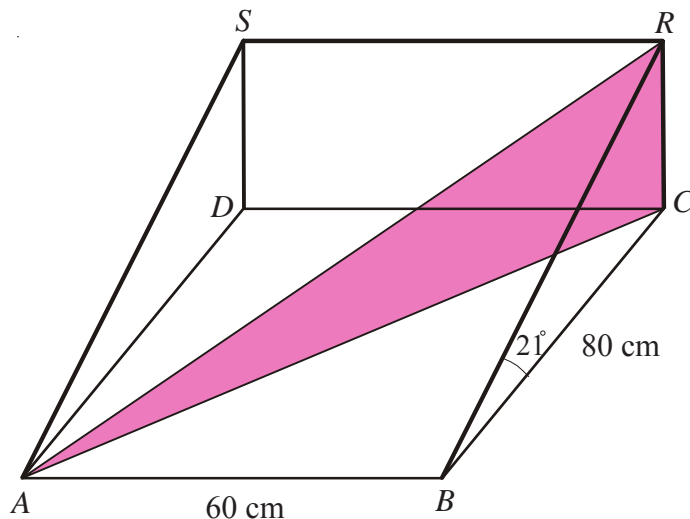

Calculate the angle that  $AR$  makes with the horizontal plane  $ABCD$ .  
Give your answer correct to 1 decimal place. **17.1°**



- 2) The diagram shows a box in the shape of a cuboid.  
A string runs diagonally across the box from  $C$  to  $E$ .

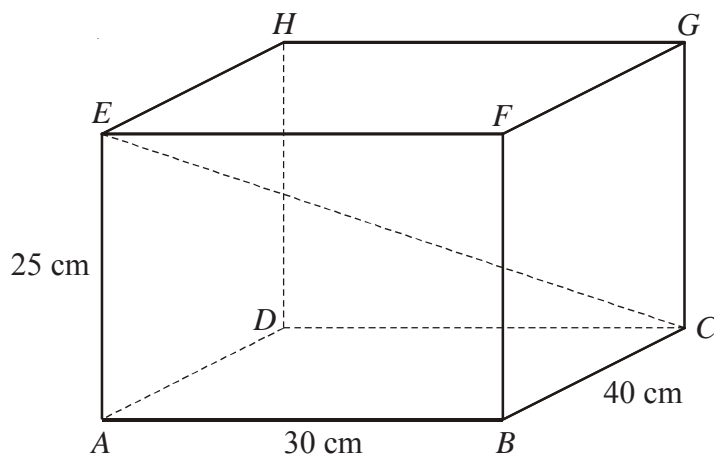

- a) Work out the length of the string  $CE$ . **55.9 cm**  
Give your answer correct to 1 decimal place.
- b) Work out the angle between the string  $CE$  and the horizontal plane  $ABCD$ .  
Give your answer correct to 1 decimal place. **26.6°**



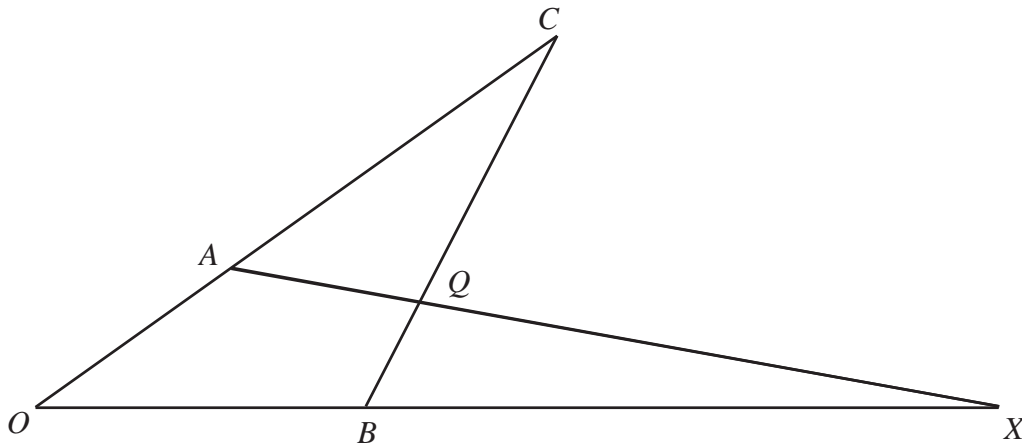

In the diagram,

$$\vec{OA} = 4\mathbf{a} \text{ and } \vec{OB} = 4\mathbf{b}$$

$OAC$ ,  $OBX$  and  $BQC$  are all straight lines.

$$AC = 2OA \text{ and } BQ : QC = 1 : 3$$

a) Find, in terms of  $\mathbf{a}$  and  $\mathbf{b}$ , the vectors which represent

(i)  $\vec{BC} = 12\mathbf{a} - 4\mathbf{b}$  or  $-4\mathbf{b} + 12\mathbf{a}$

(ii)  $\vec{AQ} = 3\mathbf{b} - \mathbf{a}$  or  $-\mathbf{a} + 3\mathbf{b}$

Given that  $\vec{BX} = 8\mathbf{b}$

b) Show that  $AQX$  is a straight line.

$$\vec{AQ} = -\mathbf{a} + 3\mathbf{b}$$

$$\vec{AX} = -4\mathbf{a} + 12\mathbf{b}$$

$$\vec{AX} = 4\vec{AQ}$$

Because  $AX$  and  $AQ$  both start from the same point,  $AQX$  is a straight line.

1)

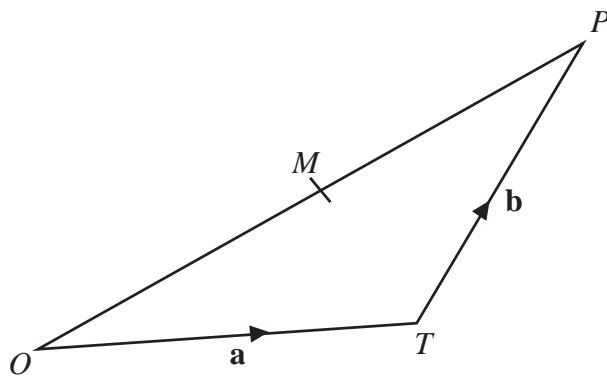

$OPT$  is a triangle.

$M$  is the midpoint of  $OP$ .

$$\vec{OT} = \mathbf{a}$$

$$\vec{TP} = \mathbf{b}$$

- a) Express  $\vec{OM}$  in terms of  $\mathbf{a}$  and  $\mathbf{b}$ .  $\vec{OM} = \frac{1}{2}(\mathbf{a} + \mathbf{b})$
- b) Express  $\vec{TM}$  in terms of  $\mathbf{a}$  and  $\mathbf{b}$ .  $\vec{TM} = \frac{1}{2}(\mathbf{b} - \mathbf{a})$   
Give your answer in its simplest form.

2)

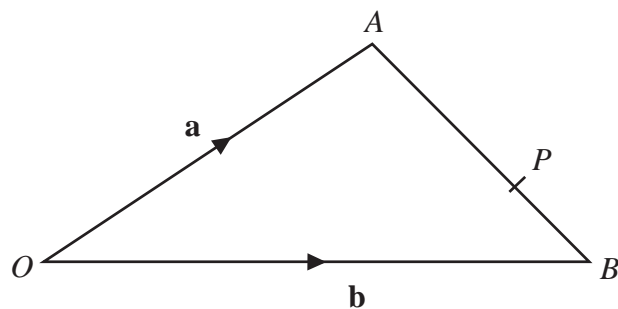

$OAB$  is a triangle.

$$\vec{OA} = \mathbf{a}, \quad \vec{OB} = \mathbf{b}$$

- a) Find the vector  $\vec{AB}$  in terms of  $\mathbf{a}$  and  $\mathbf{b}$ .  $\vec{AB} = \mathbf{b} - \mathbf{a}$

$P$  is the point on  $AB$  so that  $AP : PB = 2 : 1$

- b) Find the vector  $\vec{OP}$  in terms of  $\mathbf{a}$  and  $\mathbf{b}$ .  $\vec{OP} = \frac{1}{3}(\mathbf{a} + 2\mathbf{b})$   
Give your answer in its simplest form.

1)

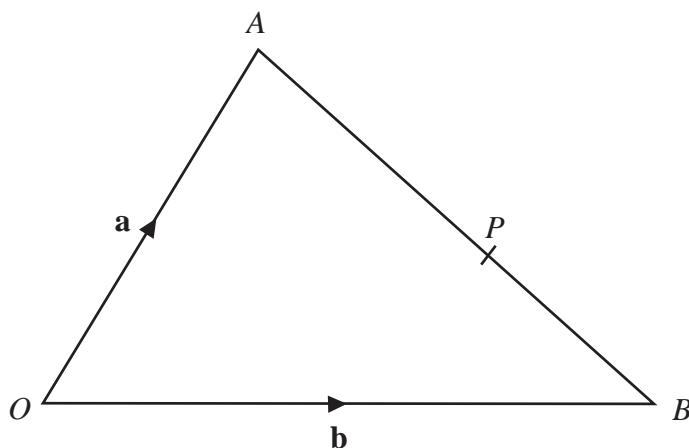

$OAB$  is a triangle.

$$\vec{OA} = \mathbf{a}, \quad \vec{OB} = \mathbf{b}$$

a) Find the vector  $AB$  in terms of  $\mathbf{a}$  and  $\mathbf{b}$ .  $\vec{AB} = \mathbf{b} - \mathbf{a}$

$P$  is the point on  $AB$  so that  $AP : PB = 3 : 2$

b) Show that  $\vec{OP} = \frac{1}{5}(2\mathbf{a} + 3\mathbf{b})$

$$\begin{aligned} \vec{OP} &= \vec{OA} + \vec{AP} \\ &= \vec{OA} + \frac{3}{5}\vec{AB} \\ &= \mathbf{a} + \frac{3}{5}(\mathbf{b} - \mathbf{a}) \\ &= \mathbf{a} + \frac{3}{5}\mathbf{b} - \frac{3}{5}\mathbf{a} \\ &= \frac{2}{5}\mathbf{a} + \frac{3}{5}\mathbf{b} \\ &= \frac{1}{5}(2\mathbf{a} + 3\mathbf{b}) \end{aligned}$$

2)

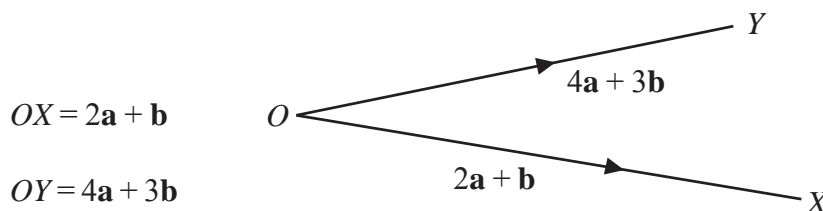

$$OX = 2\mathbf{a} + \mathbf{b}$$

$$OY = 4\mathbf{a} + 3\mathbf{b}$$

a) Express the vector  $XY$  in terms of  $\mathbf{a}$  and  $\mathbf{b}$ .  
Give your answer in its simplest form.  $\vec{XY} = 2(\mathbf{a} + \mathbf{b})$

$XYZ$  is a straight line.

$XY : YZ = 2 : 3$

b) Express the vector  $OZ$  in terms of  $\mathbf{a}$  and  $\mathbf{b}$ .  
Give your answer in its simplest form.

$$\vec{OZ} = 7\mathbf{a} + 6\mathbf{b}$$

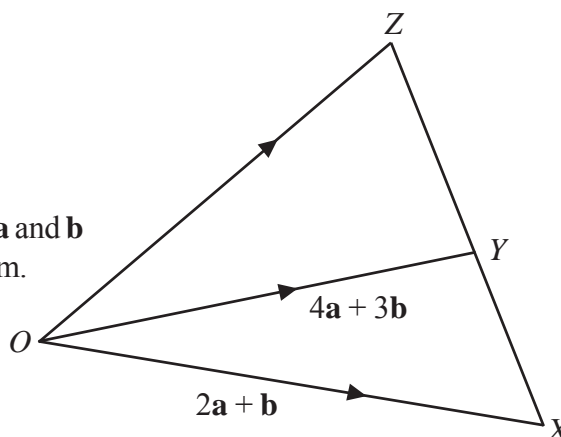

- 1) The diagram shows a trapezium  $PQRS$ .

$\vec{PQ} = \mathbf{a}$  and  $\vec{QR} = \mathbf{b}$ .

$PS$  is three times the length of  $QR$ .

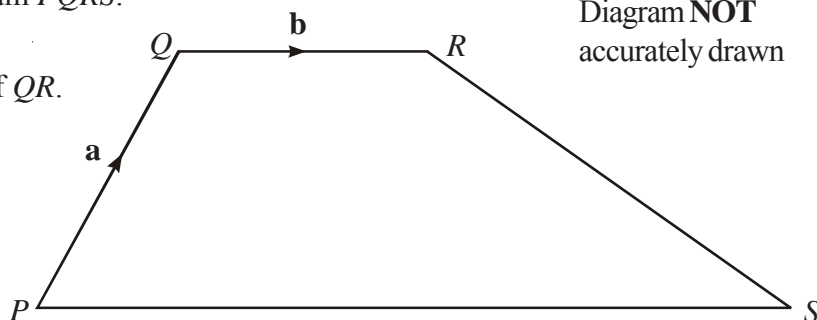

Diagram **NOT** accurately drawn

Find, in terms of  $\mathbf{a}$  and  $\mathbf{b}$ , expressions for

a)  $\vec{QP} = -\mathbf{a}$    b)  $\vec{PR} = \mathbf{a} + \mathbf{b}$    c)  $\vec{PS} = 3\mathbf{b}$    d)  $\vec{QS} = 3\mathbf{b} - \mathbf{a}$

- 2) In triangle  $ABC$ ,  $P$  and  $Q$  are the midpoints of  $AB$  and  $AC$ .

$\vec{AP} = \mathbf{p}$  and  $\vec{AQ} = \mathbf{q}$ .

Diagram **NOT** accurately drawn

- a) Find, in terms of  $\mathbf{p}$  and  $\mathbf{q}$ , expressions for

(i)  $\vec{PQ} = \mathbf{q} - \mathbf{p}$    (ii)  $\vec{AB} = 2\mathbf{p}$    (iii)  $\vec{AC} = 2\mathbf{q}$    (iv)  $\vec{BC} = 2\mathbf{q} - 2\mathbf{p}$

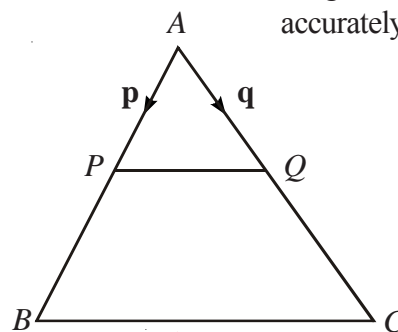

- b) Use your results from (a) to prove that  $PQ$  is parallel to  $BC$ .

$\vec{PQ} = \mathbf{q} - \mathbf{p}$   
 $\vec{BC} = 2\mathbf{q} - 2\mathbf{p}$   
 $\quad = 2(\mathbf{q} - \mathbf{p})$

Therefore  $\vec{PQ}$  is parallel to  $\vec{BC}$

- 3)

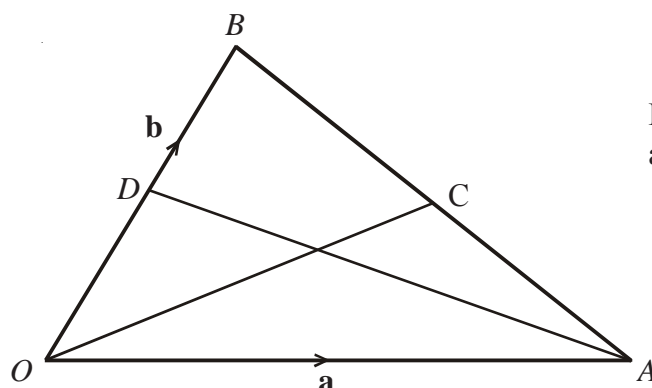

Diagram **NOT** accurately drawn

$OAB$  is a triangle.  
 $D$  is the midpoint of  $OB$ .  
 $C$  is the midpoint of  $AB$ .  
 $\vec{OA} = \mathbf{a}$  and  $\vec{OB} = \mathbf{b}$

$\vec{OC} = \vec{OA} + \vec{AC}$   
 $\vec{AC} = \frac{1}{2}\vec{AB}$   
 $\vec{AB} = -\mathbf{a} + \mathbf{b}$   
 $\vec{OC} = \mathbf{a} + \frac{1}{2}(-\mathbf{a} + \mathbf{b})$   
 $\vec{OC} = \frac{1}{2}(\mathbf{a} + \mathbf{b})$

- (i) Find  $\vec{OC}$  in terms of  $\mathbf{a}$  and  $\mathbf{b}$ .

$\vec{OC} = \frac{1}{2}(\mathbf{a} + \mathbf{b})$

- (ii) Show that  $DC$  is parallel to  $OA$ .

$\vec{DC} = \vec{DO} + \vec{OC}$   
 $\quad = -\frac{1}{2}\mathbf{b} + \frac{1}{2}(\mathbf{a} + \mathbf{b})$   
 $\quad = \frac{1}{2}\mathbf{a}$

$\vec{OA} = \mathbf{a}$    Therefore  $\vec{DC}$  is parallel to  $\vec{OA}$

1)

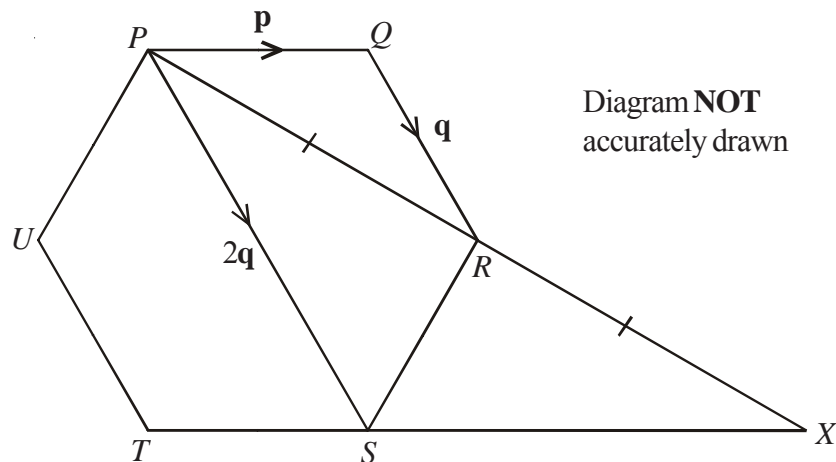

$PQRSTU$  is a regular hexagon.

$$\vec{PQ} = \mathbf{p} \quad \vec{QR} = \mathbf{q} \quad \vec{PS} = 2\mathbf{q}$$

a) Find the vector  $PR$  in terms of  $\mathbf{p}$  and  $\mathbf{q}$ .  $\vec{PR} = \mathbf{p} + \mathbf{q}$

$$\vec{PR} = \vec{RX}$$

b) Prove that  $PQ$  is parallel to  $SX$

$$\begin{aligned} \vec{SX} &= \vec{SP} + \vec{PX} \\ &= \vec{SP} + 2\vec{PR} \end{aligned}$$

$$\begin{aligned} &= -2\mathbf{q} + 2(\mathbf{p} + \mathbf{q}) \\ &= -2\mathbf{q} + 2\mathbf{p} + 2\mathbf{q} \\ &= 2\mathbf{p} \end{aligned}$$

$$\vec{PQ} = \mathbf{p} \quad \text{Therefore } \vec{PQ} \text{ is parallel to } \vec{SX}$$

2)

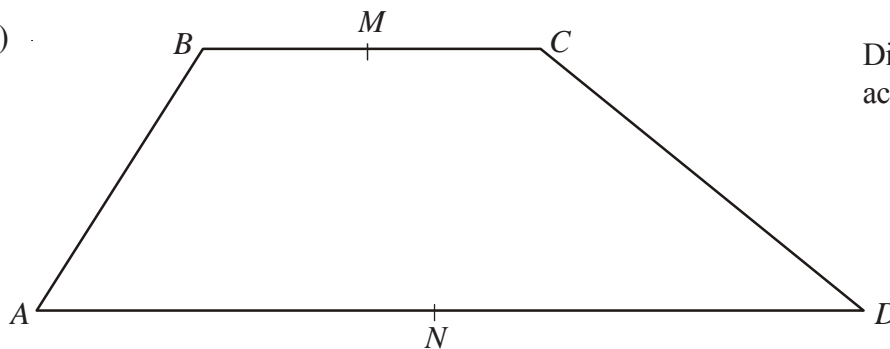

Diagram NOT accurately drawn

$ABCD$  is a trapezium with  $BC$  parallel to  $AD$ .

$$\vec{AB} = 3\mathbf{b} \quad \vec{BC} = 3\mathbf{a} \quad \vec{AD} = 9\mathbf{a}$$

$M$  is the midpoint of  $BC$  and  $N$  is the midpoint of  $AD$ .

a) Find the vector  $MN$  in terms of  $\mathbf{a}$  and  $\mathbf{b}$ .

$$\vec{MN} = 3\mathbf{a} - 3\mathbf{b}$$

$X$  is the midpoint of  $MN$  and  $Y$  is the midpoint of  $CD$ .

b) Prove that  $XY$  is parallel to  $AD$ .

$$\begin{aligned} \vec{XY} &= \vec{XN} + \vec{ND} + \vec{DY} \\ &= \frac{1}{2}\vec{MN} + \vec{ND} + \vec{DY} \\ &= \frac{1}{2}(3\mathbf{a} - 3\mathbf{b}) + 4\frac{1}{2}\mathbf{a} + \vec{DY} \\ &= 6\mathbf{a} - 1\frac{1}{2}\mathbf{b} + \vec{DY} \end{aligned}$$

$$\begin{aligned} \vec{DY} &= \frac{1}{2}\vec{DC} \\ &= \frac{1}{2}(\vec{DA} + \vec{AB} + \vec{BC}) \\ &= -4\frac{1}{2}\mathbf{a} + 1\frac{1}{2}\mathbf{b} + 1\frac{1}{2}\mathbf{a} \\ &= 1\frac{1}{2}\mathbf{b} - 3\mathbf{a} \end{aligned}$$

$$\begin{aligned} \vec{XY} &= 6\mathbf{a} - 1\frac{1}{2}\mathbf{b} + 1\frac{1}{2}\mathbf{b} - 3\mathbf{a} \\ &= 3\mathbf{a} \end{aligned}$$

Therefore  $XY$  is parallel to  $AD$